

PERI Nájemní kritéria

PERI UP Fasádní lešení



Kontakt

PERI, spol. s r.o.
bednění lešení služby

Průmyslová 392
252 42 Jesenice u Prahy
tel.: 222 359 311
info@peri.cz
www.peri.cz

Obsah	Strana	Poslední změny	Datum Inicialy	Strana
Podlaha UDS	2	Nová verze	03/2017 I fw	
Rámy	9			
Podlahová závora UHD	15			
Diagonála UBF	18			
Zábradlí UPG	21			
Podlaha se žebř. UAL	24			
Podl. zarážka dřevěná UPT-3	29			
Čelní zábradlí	31			
Vysvětlivky	35			

PERI Nájemní kritéria

PERI UP Fasádní lešení



Podlaha ocelová UDS

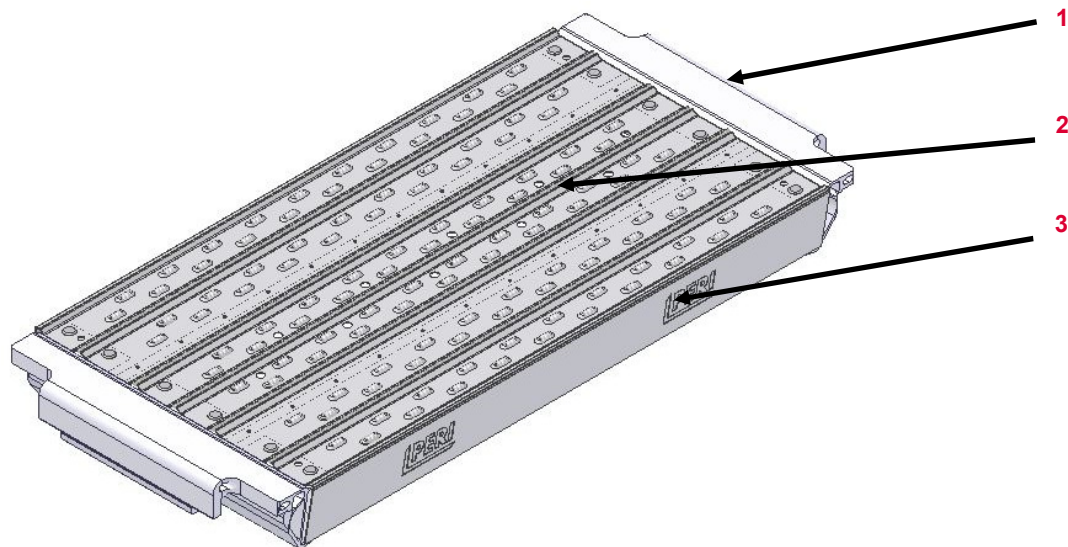















Č.	Popis	Číslo výrobku
1	Zavešovací profil	
2	Podlaha	
3	Boční profil	

Platné pro:	Číslo výrobku
Podlaha ocelová 32x72	100488
Podlaha ocelová 32x104	100486
Podlaha ocelová 32x150	100355
Podlaha ocelová 32x200	100373
Podlaha ocelová 32x250	100375
Podlaha ocelová 32x300	100377
Podlaha ocelová 32x400	100820

PERI Nájemní kritéria

PERI UP Fasádní lešení











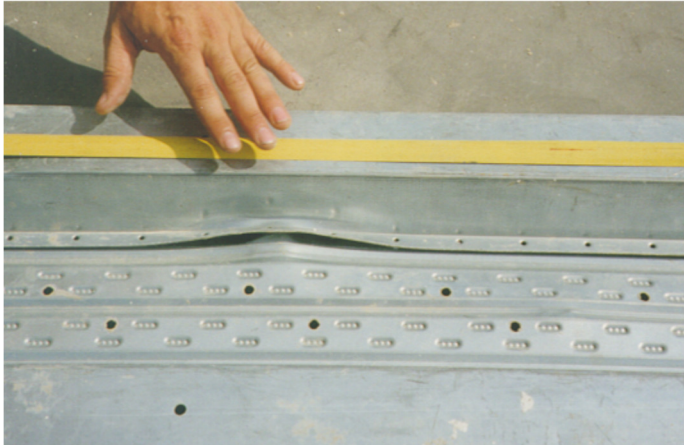





Podlaha ocelová UDS	Popis	Instrukce	Fakturace	Typ
	<p>33.20.01 Lokální poškození profilu</p> <ul style="list-style-type: none"> ■ bez poškození TOX spoje 	 		
	<p>33.20.02 Vyboulení profilu na bocích</p> <ul style="list-style-type: none"> ■ osazení podlahy je možné 	 		
	<p>33.20.03 Pruhyb konce podlážky</p>			

PERI Nájemní kritéria

PERI UP Fasádní lešení



















Podlaha ocelová UDS	Popis	Instrukce	Fakturace	Typ
	<p>33.20.04 Vyboulení horní plochy podlahy</p> <ul style="list-style-type: none"> ■ > 10 mm ■ TOX spoj je poškozen, rozevření komory 	   	 	 
	<p>33.20.05 Vyboulení bočního profilu</p> <ul style="list-style-type: none"> ■ > 10 mm 	 		

PERI Nájemní kritéria

PERI UP Fasádní lešení



Podlaha ocelová UDS	Popis	Instrukce	Fakturace	Typ
	33.20.06 Díra v podlaze <ul style="list-style-type: none"> ■ ≤ 10 mm a bez poškození bočního profilu ■ > 10 mm ■ Poškozený boční profil 	<ul style="list-style-type: none"> ✓    	<ul style="list-style-type: none">   	<ul style="list-style-type: none">  
	33.20.07 Poškození od svařování v podlaze <ul style="list-style-type: none"> ■ ≤ Ø 25 mm ■ profil poškozen (ovlivněn) ■ Žebro ovlivněno 	<ul style="list-style-type: none"> ✓    	<ul style="list-style-type: none">   	<ul style="list-style-type: none">  
	33.20.08 Rez na podlaze <ul style="list-style-type: none"> ■ Vizuální a dukladná kontrola, jestli je rez jen povrchní 	<ul style="list-style-type: none"> ✓ 	<ul style="list-style-type: none">  	<ul style="list-style-type: none"> ✓

PERI Nájemní kritéria

PERI UP Fasádní lešení



Podlaha ocelová UDS	Popis	Instrukce	Fakturace	Typ
	<p>33.20.09 Ulomené nýty</p>			
	<p>33.20.10 Poškozená pojistka podlahy</p> <ul style="list-style-type: none"> ■ Ohnutá ■ Ulomená 			
			089008 089009 (72, 104)	

PERI Nájemní kritéria

PERI UP Fasádní lešení



Podlahová lišta UD

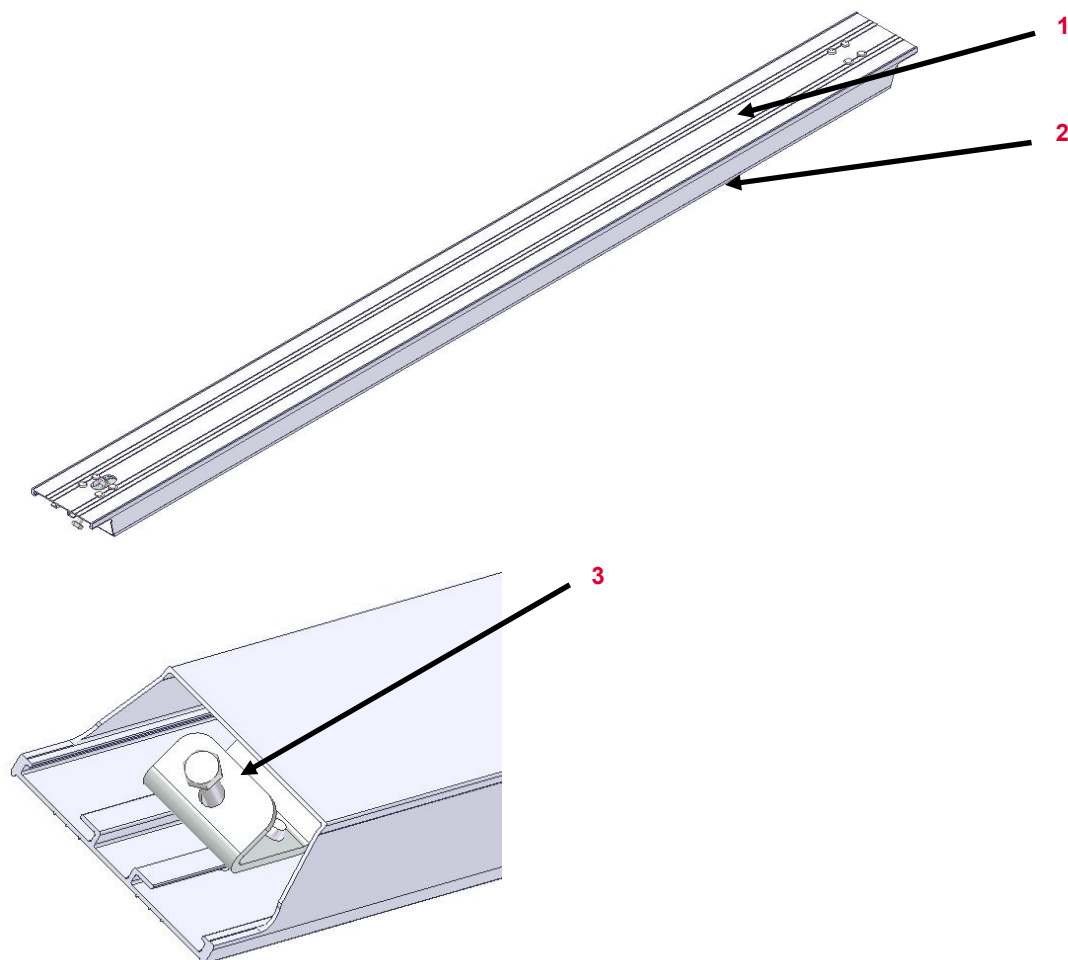









Č.	Popis	Číslo výrobku
1	Podlaha	
2	Spodní část	
3	Pojistka	

Platné pro:	Číslo výrobku
Podlahová lišta UD 7/150	101360
Podlahová lišta UD 7/200	101372
Podlahová lišta UD 7/250	101373
Podlahová lišta UD 7/300	101375
Podlahová lišta UD 11/150	101394
Podlahová lišta UD 11/200	101378
Podlahová lišta UD 11/250	101379
Podlahová lišta UD 11/300	101381

PERI Nájemní kritéria

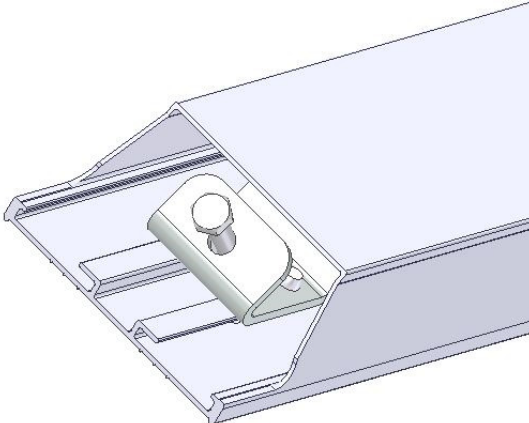
PERI UP Fasádní lešení



Podlahová lišta UD	Popis	Instrukce	Fakturace	Typ
	33.20.11 Lokální poškození ■ osazení lišty není možné			
	33.20.12 Nefunkční pojistka			

PERI Nájemní kritéria

PERI UP Fasádní lešení



Základní rám UVF, T rám UVT

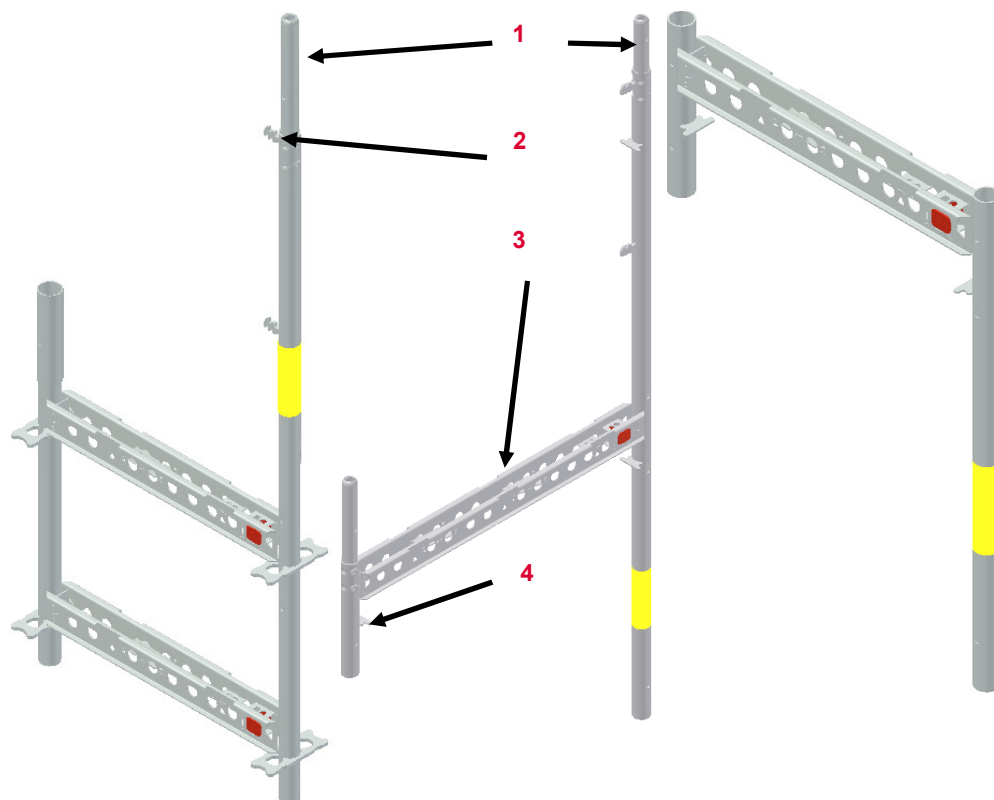





Č.	Popis	Číslo výrobku
1	Trn	
2	Trn na zábradlí	
3	Závora	
4	Stohovací plech	

Platné pro:	Číslo výrobku
Základní rám UVF 72/124	100200
Základní rám UVF 104/124	100208
Základní rám UVF 72/174	100170
Základní rám UVF 104/174	100172
T rám UVT 72/200	100212
T rám UVT 104/200	100216
L rám UVL 72/100	100217
L rám UVL 104/100	100219
Chodníkový rám UVG 104/240	106965
Chodníkový rám UVG 176/240	100322

PERI Nájemní kritéria

PERI UP Fasádní lešení

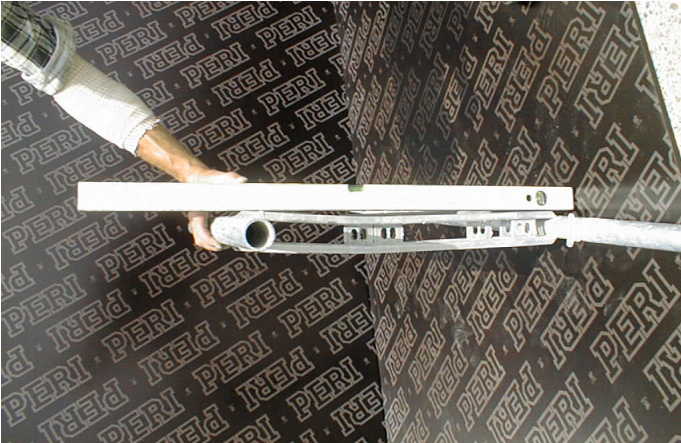







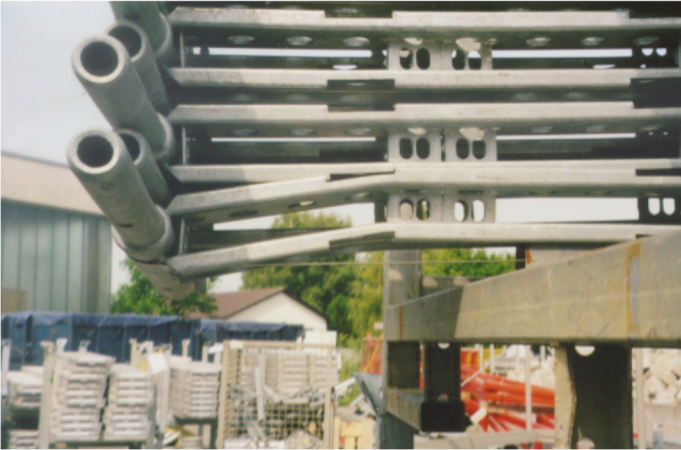

Poškozený rám	Popis	Instrukce	Fakturace	Typ
	33.20.13 Ohnutý vertikální sloupek			
	<ul style="list-style-type: none"> ■ Bez zlomů a do ≤ 15 cm 		 088244	
	<ul style="list-style-type: none"> ■ > 15 cm 	 		
	33.20.14 Ohnutý profil			
	<ul style="list-style-type: none"> ■ osazení podlahy je možné lokální poškození závory 		 088244	
	<ul style="list-style-type: none"> ■ osazení podlahy není možné 	 		

PERI Nájemní kritéria

PERI UP Fasádní lešení











Poškozený rám	Popis	Instrukce	Fakturace	Typ
	33.20.15 Ohnutá podlahová závora	 		
	33.20.16 Ohnutý stohovací plech ■ Bez poškození sváru		 088244	

PERI Nájemní kritéria

PERI UP Fasádní lešení













Poškozený rám	Popis	Instrukce	Fakturace	Typ
	33.20.17 Chybející stohovací plech			
	33.20.18 Trn vertikálního sloupku je ohnutý ■ zřetelné deformace	 		

PERI Nájemní kritéria

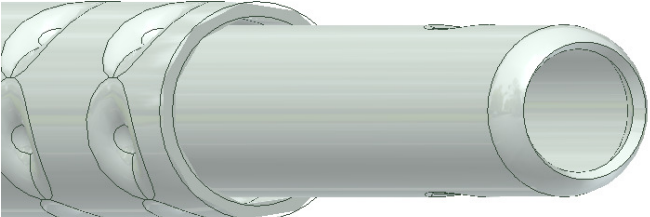
PERI UP Fasádní lešení













Poškozený rám	Popis	Instrukce	Fakturace	Typ
	33.20.19 Ohnutý trn na zábradlí <ul style="list-style-type: none"> Možná oprava 			
	<ul style="list-style-type: none"> Oprava není možná 			
	33.20.20 Deformovaný trn <ul style="list-style-type: none"> zřetelné deformace 			

PERI Nájemní kritéria

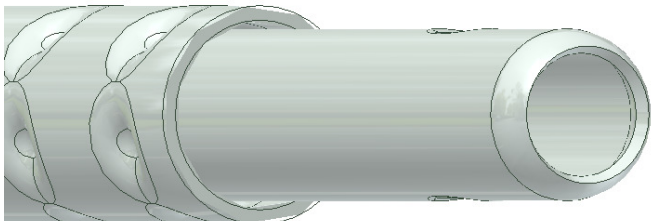
PERI UP Fasádní lešení



Nástavec UV 165 (100220)	Popis	Instrukce	Fakturace	Typ
	33.20.21 Ohnutý trn na zábradlí	<ul style="list-style-type: none"> Možná oprava 		
	<ul style="list-style-type: none"> Oprava není možná 	 		
	33.20.22 Deformovaný trn	 		
	<ul style="list-style-type: none"> zřetelné deformace 			

PERI Nájemní kritéria

PERI UP Fasádní lešení



Podlahová závora UHD

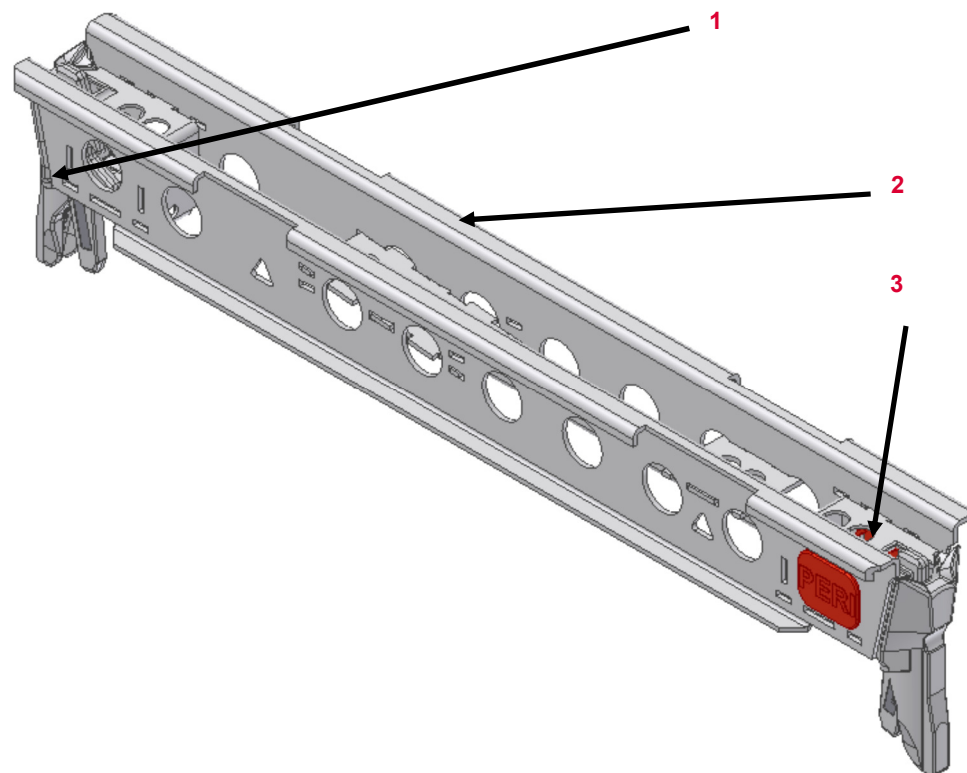

Č.	Popis	Číslo výrobku
1	Klínek	
2	Profil	
3	Hlava podlahové závory	

Platné pro:	Číslo výrobku
Podlahová závora UHD 72	100031
Podlahová závora UHD 104	100039
Podlahová závora UHD 150	100076
Podlahová závora UHD 200	100079
Podlahová závora UHD 250	100082
Podlahová závora UHD 300	100085

PERI Nájemní kritéria

PERI UP Fasádní lešení



Podlahová závora UHD	Popis	Instrukce	Fakturace	Typ
----------------------	-------	-----------	-----------	-----



33.20.23 Ohnutý profil

- > Pov. ohnutí (L/300)



Výrobek	Pov. ohnutí
UHD 72	3 mm
UHD 104	4 mm
UHD 150	5 mm
UHD 200	7 mm
UHD 250	8 mm
UHD 300	10 mm



33.20.24 Poškozená hlava

- Je možná oprava













- Poškozený svár



PERI Nájemní kritéria

PERI UP Fasádní lešení



Podlahová závora UHD	Popis	Instrukce	Fakturace	Typ
	33.20.25 Lokální ohnutí v profilu	 	 088244	
	33.20.26 Chybející klínek ulomený pojišťovací plech	 		

PERI Nájemní kritéria

PERI UP Fasádní lešení



Diagonála UBF	Č.	Popis	Číslo výrobku
---------------	----	-------	---------------

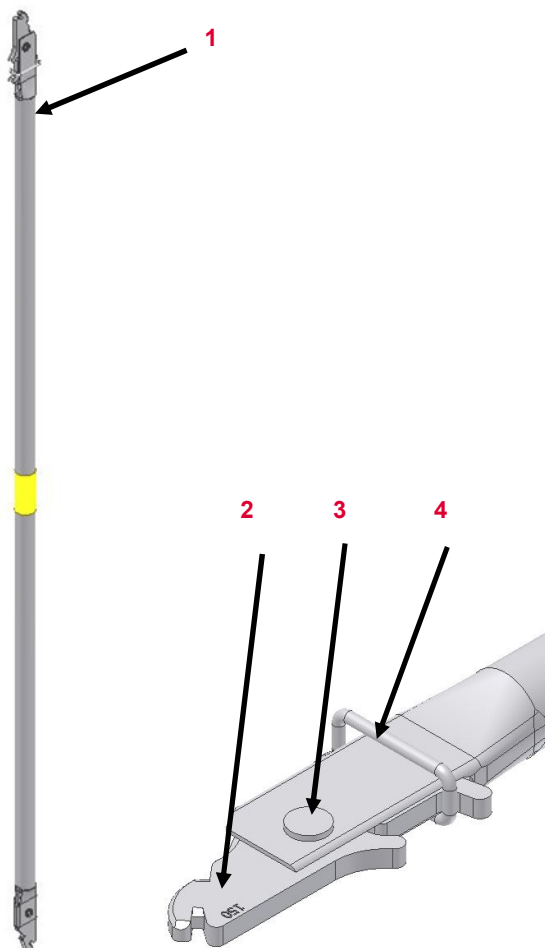

1	Trubka	
2	Hlava diagonály	
3	Čep	100251
4	Bezpečnostní kroužek	100252

Platné pro:	Číslo výrobku
Diagonála UBF 150/200	100247
Diagonála UBF 200/200	100253
Diagonála UBF 250/200	100257
Diagonála UBF 300/200	100261

PERI Nájemní kritéria

PERI UP Fasádní lešení



Diagonála UBF	Popis	Instrukce	Fakturace	Typ
---------------	-------	-----------	-----------	-----

33.20.27 Ohnutá trubka



- ≤ Pov. ohnutí (L/500)
- > povolené ohnutí



088244



Výrobek	povolené ohnutí
UBF 150/200	4 mm
UBF 200/200	5 mm
UBF 250/200	6 mm
UBF 300/200	7 mm



33.20.28 Dolní hlava je ulomená















100249 (dolní hlava)
100250 (horní hlava)



PERI Nájemní kritéria

PERI UP Fasádní lešení



Diagonála UBF	Popis	Instrukce	Fakturace	Typ
	<p>33.20.29 Hlava diagonály je vyhnutá</p> <ul style="list-style-type: none"> ■ > 5 mm 	 <p>100249 (dolní hlava) 100250 (horní hlava)</p>		
	<p>33.20.30 Hlava diagonály je silně znečištěná</p> <ul style="list-style-type: none"> ■ lze očistit ■ Očištění není možné 	  	 	 

PERI Nájemní kritéria

PERI UP Fasádní lešení



Zábradlí UPG



Č.	Popis	Číslo výrobku
1	Koncovka	
2	Trubka	

Platné pro:	Číslo výrobku
Zábradlí UPG 72	107045
Zábradlí UPG 104	107050
Zábradlí UPG 150	100265
Zábradlí UPG 200	100266
Zábradlí UPG 250	100267
Zábradlí UPG 300	100268
Zábradlí UPG 400	100810

PERI Nájemní kritéria

PERI UP Fasádní lešení



Zábradlí UPG	Popis	Instrukce	Fakturace	Typ
--------------	-------	-----------	-----------	-----



33.20.31 Zábradlí ohnuté

■ Bez vyboulení na profilu
a \leq povolení ohnutí (l/100)



■ Vyboulení profilu



■ $>$ Pov. ohnutí (l/100)



Výrobek	Pov. ohnutí
UPG 150	15 mm
UPG 200	20 mm
UPG 250	25 mm
UPG 300	30 mm
UPG 400	35 mm

PERI Nájemní kritéria

PERI UP Fasádní lešení

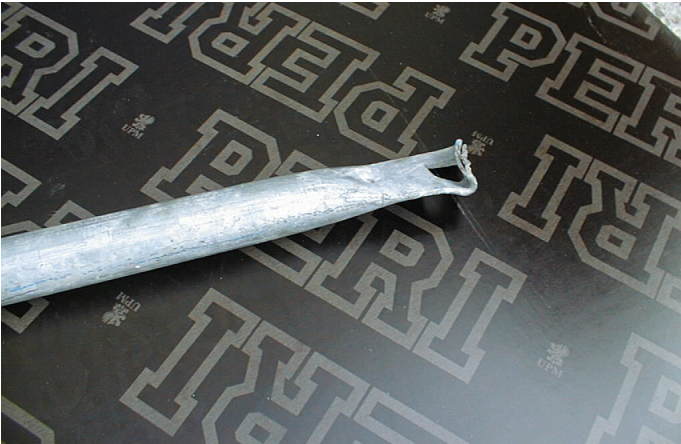

Zábradlí UPG	Popis	Instrukce	Fakturace	Typ
	33.20.32 Koncovka profilu <ul style="list-style-type: none"> Max. vychýlený úhel < 45° 			
	33.20.33 Koncovka je značně poškozená <ul style="list-style-type: none"> Prasklina v profilu vychýlený úhel > 45° 	 	 	

PERI Nájemní kritéria

PERI UP Fasádní lešení



Podlaha se žebř. UAL

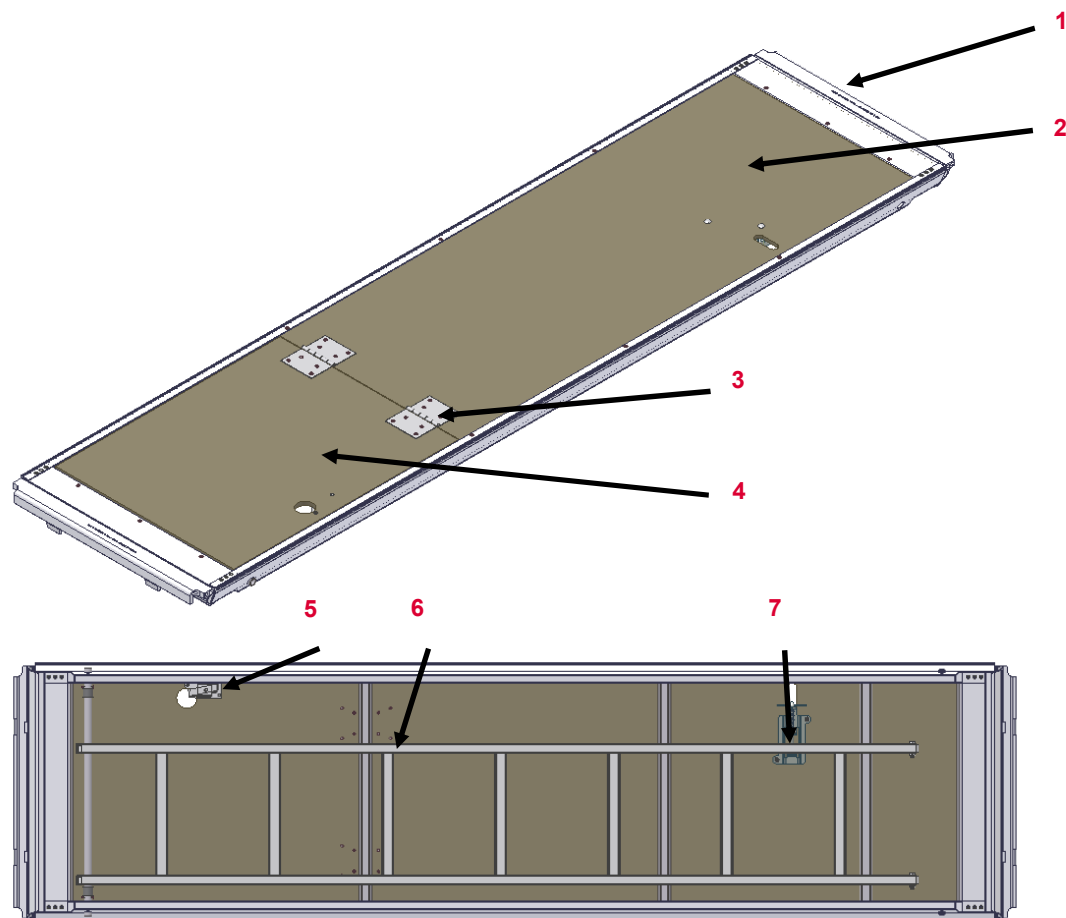











Č.	Popis	Číslo výrobku
1	Zavěšovací profil	114667
2	Podlaha	
3	Závěsy	100468
4	Poklop	114671
5	Západka	115566
6	Žebřík	100470
7	Držák žebříku	126588

Platné pro:	Číslo výrobku
Podlaha se žebř. UAL-2 64x250/3	114825
Podlaha se žebř. UAL-2 64x300/3	114812
Podlaha se žebř. UAL-3 64x250/3K	126481
Podlaha se žebř. UAL-3 64x300/3K	126482
Podlaha se žebř. UAL-3 64x200/3K	126480
Podlaha se žebř. UAL-3 64x200/3	114811

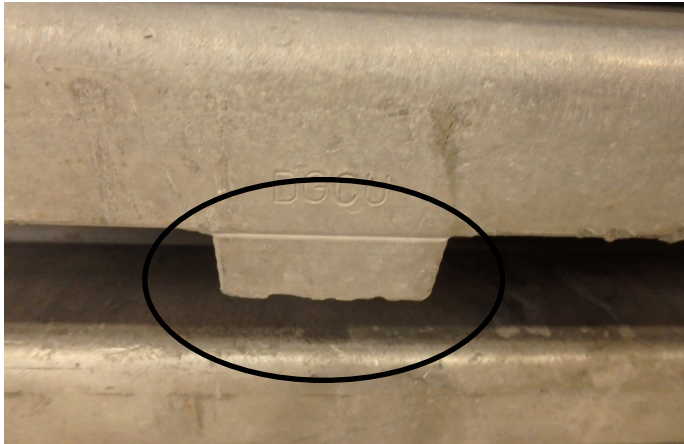
PERI Nájemní kritéria

PERI UP Fasádní lešení

















Podlaha se žebř. UAL	Popis	Instrukce	Fakturace	Typ
	<p>33.20.34 Lokální poškození profilu</p> <ul style="list-style-type: none"> ■ osazení podlahy je možné, poklop lze zavřít 	 		
	<p>33.20.35 Zavěšovací profil</p> <ul style="list-style-type: none"> ■ Zavěšovací profil prasknutý ■ Zavěšovací profil odtržený 	 	 	 

PERI Nájemní kritéria

PERI UP Fasádní lešení



Podlaha se žebř. UAL	Popis	Instrukce	Fakturace	Typ
	<p>33.20.36 Žebřík</p> <ul style="list-style-type: none"> ■ Prasklý svár ■ Chybějící ■ Prohlubeňv příčce 	<ul style="list-style-type: none">    	<ul style="list-style-type: none">    	<ul style="list-style-type: none">   
	<p>33.20.37 Díra v profilu</p>	<ul style="list-style-type: none">   	<ul style="list-style-type: none">  	<ul style="list-style-type: none"> 

PERI Nájemní kritéria

PERI UP Fasádní lešení

















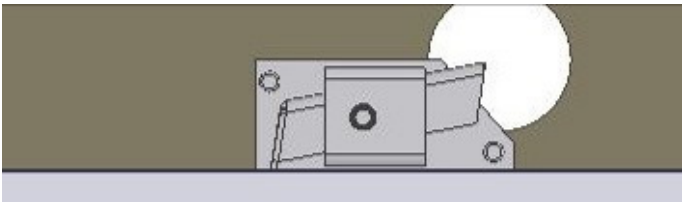

Podlaha se žebř. UAL	Popis	Instrukce	Fakturace	Typ
	33.20.38 Poškozený svár na výztuže <ul style="list-style-type: none">není poškozená výztuha			
	33.20.39 Poškozený svár na výztuže <ul style="list-style-type: none">Poškozená výztuha		088273	

PERI Nájemní kritéria

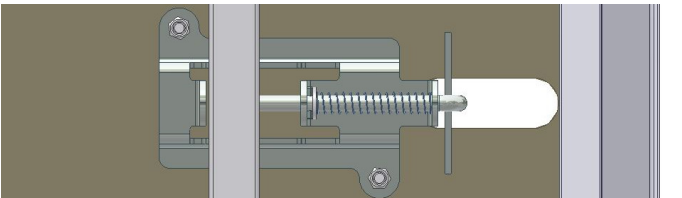
PERI UP Fasádní lešení



Podlaha se žebř. UAL	Popis	Instrukce	Fakturace	Typ
	33.20.40 Díra v prekližce			
	33.20.41 Zničené závěsy		 089030	
	33.20.42 Poškozená západka		 089024	
	33.20.43 Držák žebříku poškozený			

PERI Nájemní kritéria

PERI UP Fasádní lešení



Podl. zarážka dřevěná UPT-3

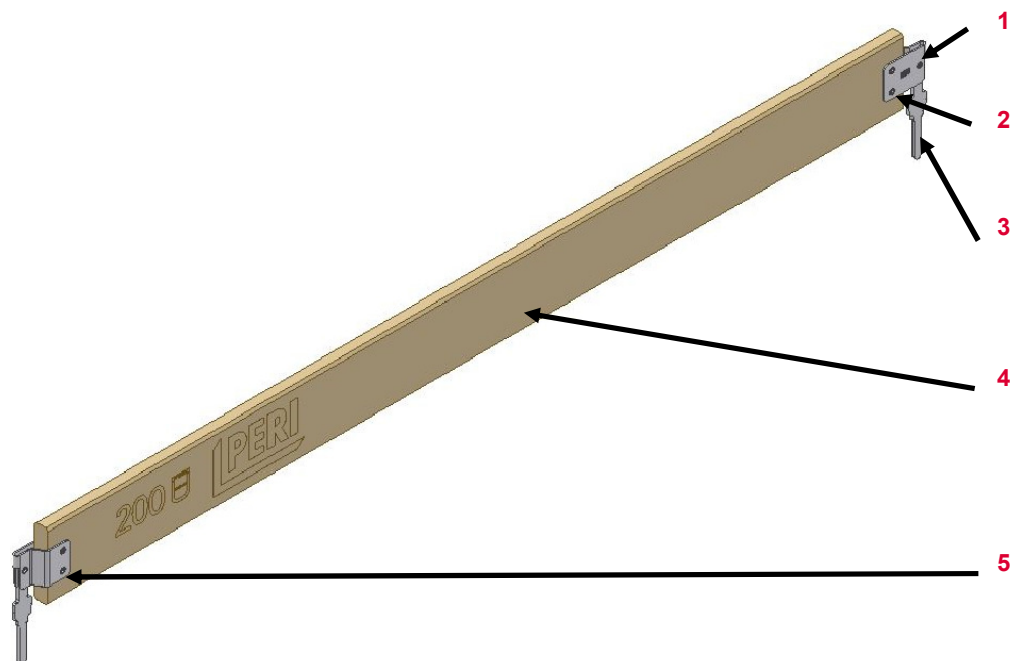















Č.	Popis	Číslo výrobku
1	Nýt 75x18	100136
2	Nýt DIN 75x41	100384
3	Kolík podlahové zarážky	125169
4	Prkno	
5	Kování podlahové zarážky	108065

Platné pro:	Číslo výrobku
Podl. zarážka dřevěná UPT-3 72	126858
Podl. zarážka dřevěná UPT-3 104	126868
Podl. zarážka dřevěná UPT-3 150	125172
Podl. zarážka dřevěná UPT-3 200	125173
Podl. zarážka dřevěná UPT-3 250	125174
Podl. zarážka dřevěná UPT-3 300	125175
Podl. zarážka dřevěná UPT-3 400	125176

PERI Nájemní kritéria

PERI UP Fasádní lešení



Podl. zarážka dřevěná UPT-3	Popis	Instrukce	Fakturace	Typ
	33.20.44 Zavěšovací profil poškozený	 100385 (Zavěšovací profil) 100383 (Trn) 100384 (Nýt 8x75x41) 100699 (Nýt 8x75x23)		
	33.20.45 Poškozené prkno	 		
	33.20.46 Opatřebované prkno	 		

PERI Nájemní kritéria

PERI UP Fasádní lešení



Čelní zábradlí UPX

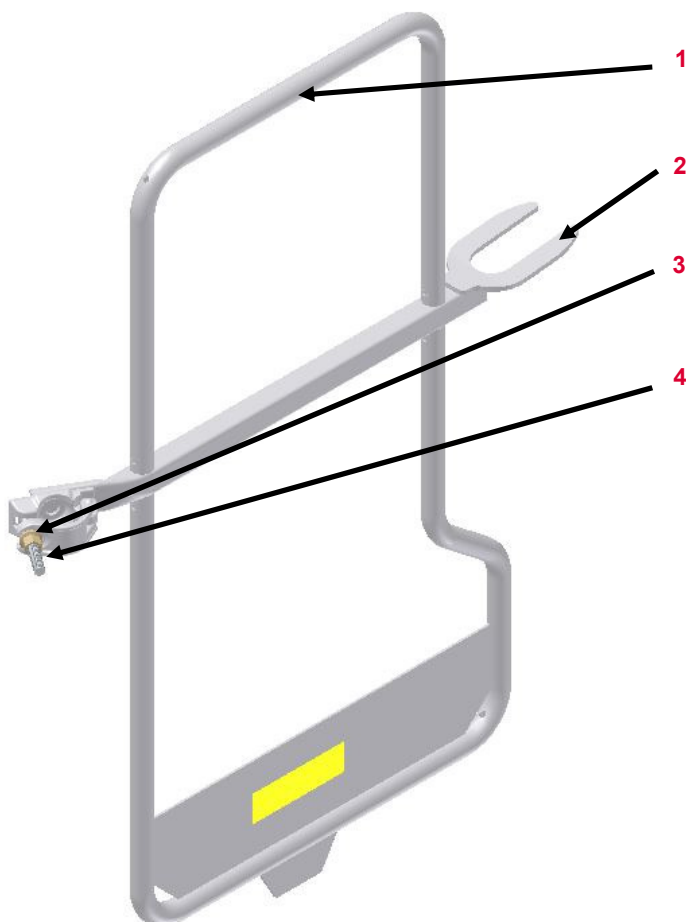









Č.	Popis	Číslo výrobku
1	Čelní zábradlí	
2	Vidlice	
3	Matice	710340
4	Šroub	710290

Platné pro:	Číslo výrobku
Čelní zábradlí UPX 32	101579
Čelní zábradlí UPX 74	100444
Čelní zábradlí UPX 104	100349

PERI Nájemní kritéria

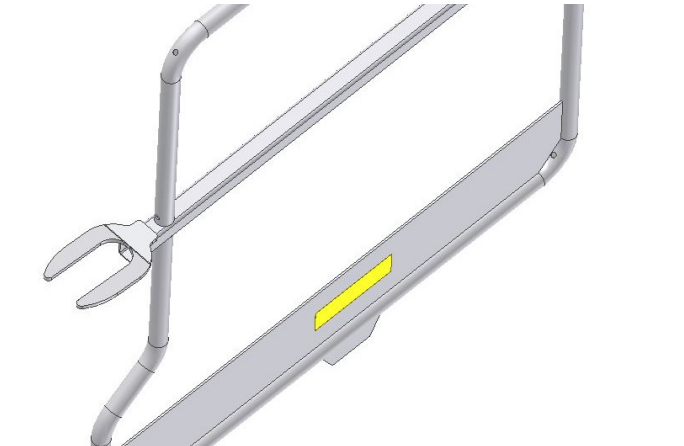
PERI UP Fasádní lešení



Čelní zábradlí UPX	Popis	Instrukce	Fakturace	Typ
	<p>33.20.47 Vidlice ohnutá</p> <ul style="list-style-type: none">■ Tolerance □ 20 mm , vychýlení vidlic (12 mm)		 088244	
	33.20.48 Ohnutý plech		 088244	

PERI Nájemní kritéria

PERI UP Fasádní lešení



Trn UES (101576)	Popis	Instrukce	Fakturace	Typ
------------------	-------	-----------	-----------	-----



33.20.49 Chybející upínací vložka



710910



089402



33.20.50 Ohnutý klín



101568 (Klín)
710910



PERI Nájemní kritéria

PERI UP Fasádní lešení



Základový nosník UVA (101702; 100870)	Popis	Instrukce	Fakturace	Typ
---------------------------------------	-------	-----------	-----------	-----



33.20.51 Chybející upínací vložka



710910



089042



33.20.52 Chybející zarážka



101689



089036



- Bez dalších poškození

PERI Nájemní kritéria

Vysvětlivky znaků



Znak	Význam	Znak	Význam	Znak	Význam
	Není v pořádku – materiál je poškozený		Fakturuje se zákazníkovi		Optické poškození
	OK – materiál zůstává v nájemním skladu		Nefakturuje se zákazníkovi		Funkční poškození
	Poškozený materiál – není dovoleno vydávat materiál z bezpečnostních důvodů		Zkrácení prvku		Funkční poškození — není dovoleno vydávat materiál z bezpečnostních důvodů
	Oprava dle instrukcí		Označení prvku barvou		Statické poškození — není dovoleno vydávat materiál z bezpečnostních důvodů
	Oprava za studena — poté kontrola svárů a sousedních dílů		Výměna poškozeného dílu		
	Oprava po výpočtu hospodárnosti		Doplnění chybějícího dílu		
	Očištění materiálu				