

PERI Nájemní kritéria

Fasádní lešení PERI UP



Kontakt

PERI, spol. s r.o.
bednění lešení služby

Průmyslová 392
 252 42 Jesenice u Prahy
 tel.: 222 359 311
 info@peri.cz
 www.peri.cz

| Obsah | Str. |
|------------------------------|------|
| Průmyslové podlahy UDI / UDG | 2 |
| Podlahy UAL | 9 |
| Horizontály UH | 12 |
| Sloupky | 19 |
| Patky | 23 |
| Diagonály | 28 |
| Příslušenství | 37 |
| Podlahy UAA and UAW | 49 |
| Lešenářské spojky | 60 |

| Poslední změny | Datum Iniciály | Str. |
|------------------------------------|------------------|-------|
| Nová verze | 02/17 fw | |
| Podlahy UAA a UAW přidány | 01/19 fw | 45 |
| Přidán neoriginální profil pro UBL | 12/20 fw | 26 |
| Flex-2 přidány výrobky | 06/21 fw | |
| Značení lešenářských spojů | 08/21 fw | 60 |
| Změny v lešenářských spojkách | 03/22 fw | 60-63 |
| Přidány lešenářské trubky | 03/22 fw | 64-65 |

PERI Nájemní kritéria

Fasádní lešení PERI UP



| Průmyslová Podlaha UDI UDG UDG-2 | Číslo | Popis | Číslo výrobku |
|--------------------------------------|-------|-------|---------------|
|--------------------------------------|-------|-------|---------------|

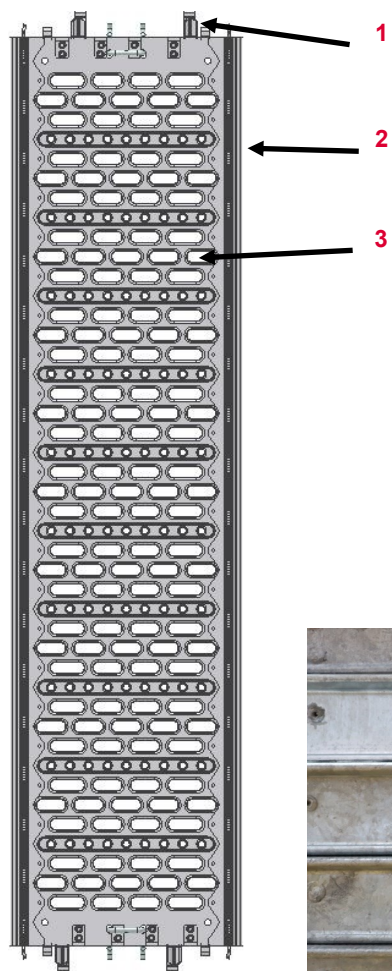

| | |
|---|--------------|
| 1 | Kování |
| 2 | Boční profil |
| 3 | Podlaha |

Boční profil UDG s dírami



Boční profil UDI bez děr



PERI Nájemní kritéria

Fasádní řešení PERI UP



| Výrobek | Číslo výrobku |
|---------------------------------|---------------|
| Průmyslová podlaha UDI 37,5x50 | 111685 |
| Průmyslová podlaha UDI 37,5x75 | 111687 |
| Průmyslová podlaha UDI 37,5x100 | 111686 |
| Průmyslová podlaha UDI 37,5x125 | 111860 |
| Průmyslová podlaha UDI 37,5x150 | 111863 |
| Průmyslová podlaha UDI 37,5x200 | 111864 |
| Průmyslová podlaha UDI 37,5x250 | 111865 |
| Průmyslová podlaha UDI 37,5x300 | 111969 |
| Průmyslová podlaha UDI 25x50 | 104029 |
| Průmyslová podlaha UDI 25x75 | 105925 |
| Průmyslová podlaha UDI 25x100 | 106092 |
| Průmyslová podlaha UDI 25x125 | 106880 |
| Průmyslová podlaha UDI 25x150 | 107002 |

| Výrobek | Číslo výrobku |
|---------------------------------|---------------|
| Průmyslová podlaha UDI 25x200 | 108380 |
| Průmyslová podlaha UDI 25x250 | 108540 |
| Průmyslová podlaha UDI 25x300 | 108689 |
| Průmyslová podlaha UDG 25 x 50 | 124124 |
| Průmyslová podlaha UDG 25 x 75 | 124121 |
| Průmyslová podlaha UDG 25 x 100 | 124118 |
| Průmyslová podlaha UDG 25 x 125 | 124115 |
| Průmyslová podlaha UDG 25 x 150 | 124112 |
| Průmyslová podlaha UDG 25 x 200 | 124109 |
| Průmyslová podlaha UDG 25 x 250 | 123771 |
| Průmyslová podlaha UDG 25 x 300 | 124915 |

PERI Nájemní kritéria

Fasádní řešení PERI UP



| Výrobek | Číslo výrobku |
|-----------------------------------|---------------|
| Průmyslová podlaha UDG-2 25 x 50 | 132479 |
| Průmyslová podlaha UDG-2 25 x 67 | 132483 |
| Průmyslová podlaha UDG-2 25 x 75 | 132488 |
| Průmyslová podlaha UDG-2 25 x 100 | 132492 |
| Průmyslová podlaha UDG-2 25 x 125 | 132502 |
| Průmyslová podlaha UDG-2 25 x 150 | 132505 |
| Průmyslová podlaha UDG-2 25 x 200 | 132508 |
| Průmyslová podlaha UDG-2 25 x 250 | 132511 |
| Průmyslová podlaha UDG-2 25 x 300 | 132515 |
| | |
| | |
| | |
| | |
| | |
| | |
| | |
| | |
| | |

PERI Nájemní kritéria

Fasádní lešení PERI UP



| UDI UDG | Popis | Instrukce | Fakturace | Typ |
|-----------|-------|-----------|-----------|-----|
|-----------|-------|-----------|-----------|-----|



Ohnutý boční profil

- Podlahu je možné osadit. (Tox spoj nesmí být poškozen)
- Osazení není možné
- Tox- Spoj je poškozený

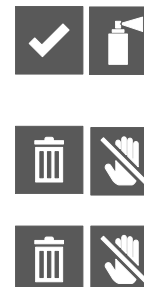

Ohnutá podlaha

- $> 1/100$
- Nebo $> 15 \text{ mm}$

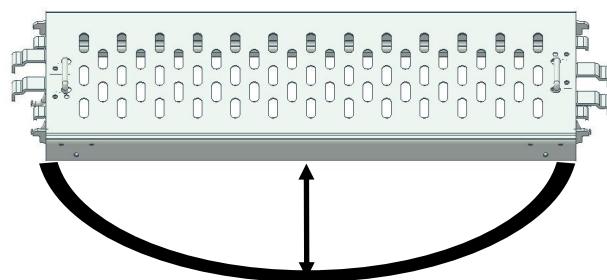









| Délka podlahy | Povolené ohnutí |
|--------------------|-----------------|
| 50 | 5,0 mm |
| 75 | 7,5 mm |
| 100 | 10 mm |
| 125 | 12,5 mm |
| 150; 200; 250; 300 | 15,0 mm |

PERI Nájemní kritéria

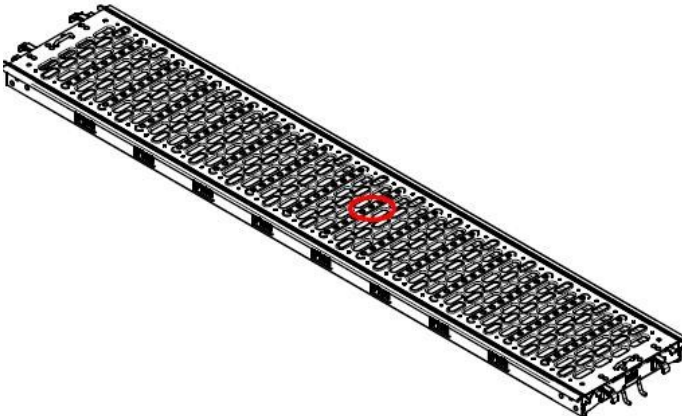
Fasádní lešení PERI UP























| UDI UDG | Popis | Instrukce | Fakturace | Typ |
|---|-----------------------------------|--|--|--|
|  | Řezy v profilu podlahy |  |  |  |
|  | Díry v podlaze ■ > Ø 25 mm |  |  |  |

PERI Nájemní kritéria

Fasádní lešení PERI UP







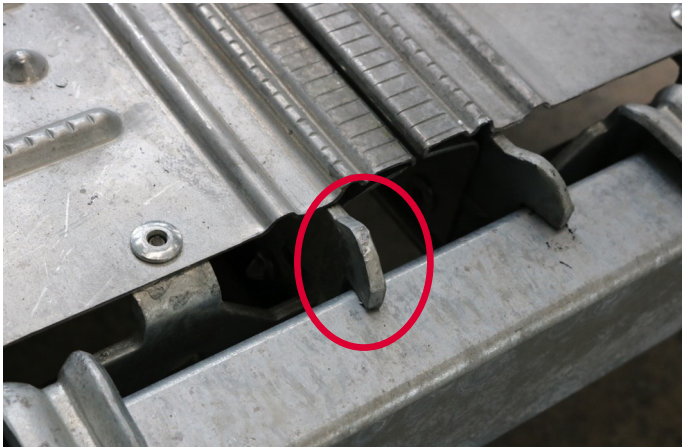

| UDI UDG | Popis | Instrukce | Fakturace | Typ |
|-----------|---|--|--|---|
| | Praskliny v háčcích kování | <ul style="list-style-type: none">  108714 (Kování 25) 111482 (Kování 37,5) UDI 37,5 |  089007 |  |
| | <ul style="list-style-type: none">  UDG (svařované verze) |   |  |  |
| | Ohnuté háčky v kování | <ul style="list-style-type: none">   Bez prasklin v háčcích a ohnutí ≤ 5 mm |  |  |
| | <ul style="list-style-type: none">  Ohnutí > 5 mm a UDI nebo UDG nýtováno | <ul style="list-style-type: none">  108714 (Kování 25) 111482 (Kování 37,5) UDI 37,5 |  |  |
| | <ul style="list-style-type: none">  Ohnutí > 5 mm a UDG svařeno |   |  |  |

PERI Nájemní kritéria

Fasádní lešení PERI UP



| UDI UDG | Popis | Instrukce | Fakturace | Typ |
|---|---|--|--|--|
|  | Ohnutý hák v kování <ul style="list-style-type: none">■ Bez prasklin v materiálu■ S prasklinami v materiálu |   |   |   |

PERI Nájemní kritéria

Fasádní lešení PERI UP



Podlaha se žebříkem UAL-3

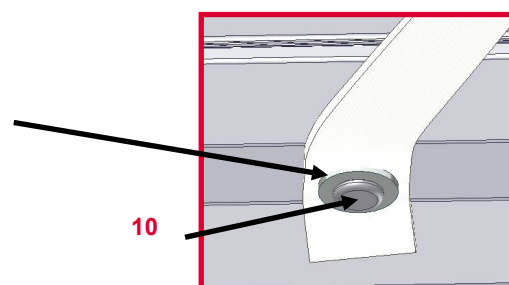
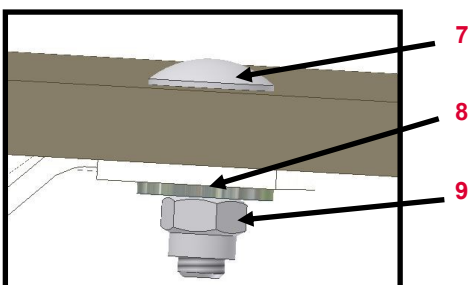
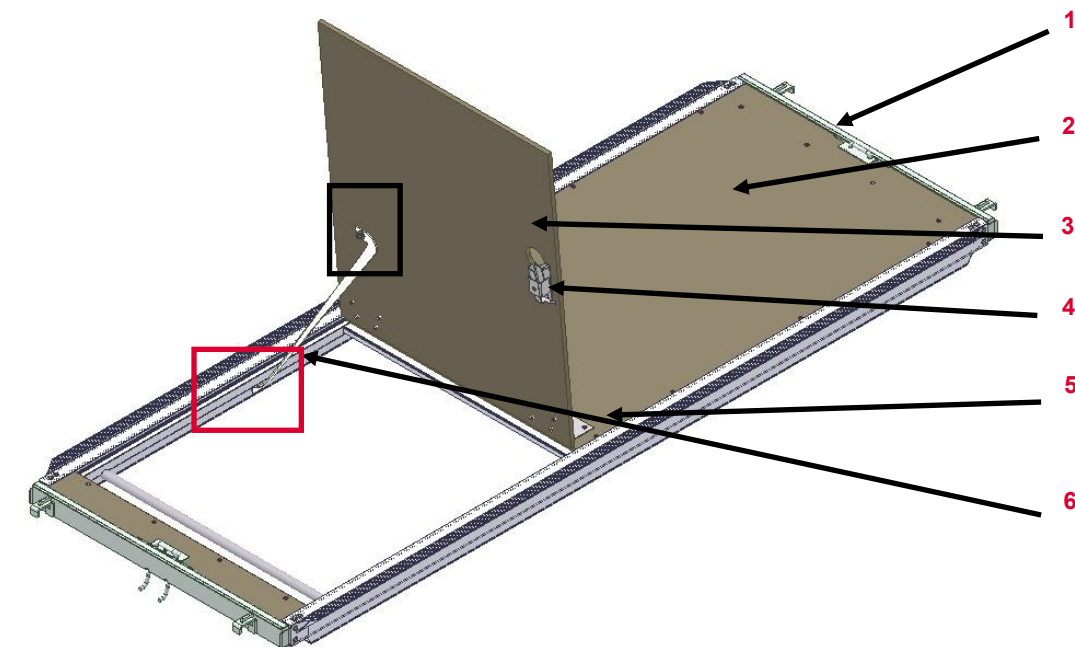









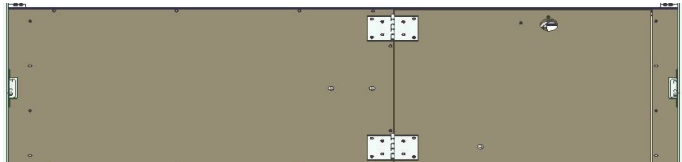

| Číslo | Popis | Číslo výrobku |
|-------|-------------------|---------------|
| 1 | Kování UAL | 128329 |
| 2 | Překližka | |
| 3 | Poklop UAL 75 | 126303 |
| 4 | Západka pro UAL-2 | 115566 |
| 5 | Pant | 128319 |
| 6 | Plastová páska | 127472 |
| 7 | Šroub M 6 x 25 | 127348 |
| 8 | Disk | 127036 |
| 9 | Matice M 6 | 129396 |
| 10 | Nýt | 127334 |

| Platné pro | Číslo výrobku |
|------------------------------------|---------------|
| Podlaha se žebříkem UAL-3 75x150/3 | 126393 |
| Podlaha se žebříkem UAL-3 75x200/3 | 126392 |
| Podlaha se žebříkem UAL-3 75x250/3 | 126314 |

PERI Nájemní kritéria

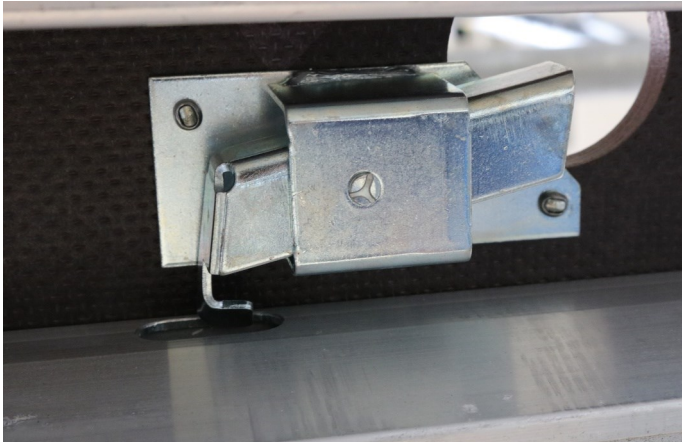
Fasádní lešení PERI UP











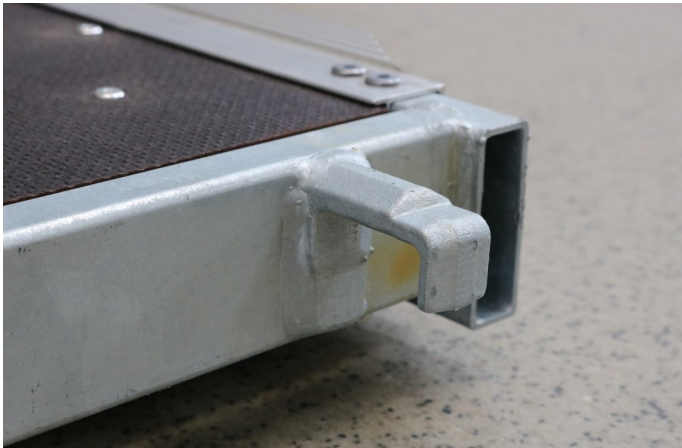

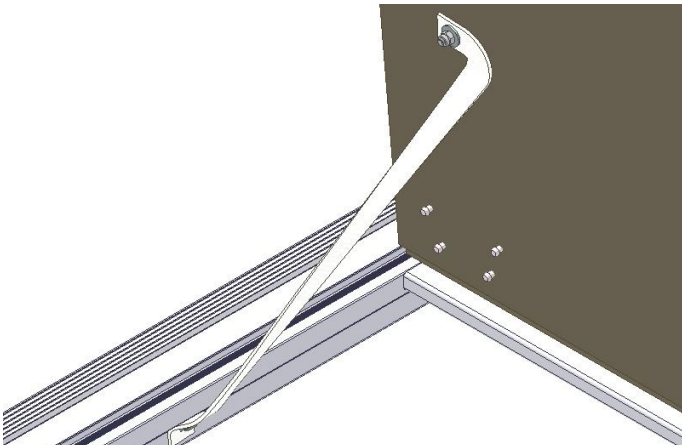

| Podlahy | Popis | Instrukce | Fakturace | Typ |
|--|---|--|--|--|
|  | Dřevěná podlaha | | | |
| | <ul style="list-style-type: none"> ■ Opotřebovaná |  |  |  |
| | <ul style="list-style-type: none"> ■ Poškozená silou |  |  |  |
|  | Poškozená západka |  |  |  |

PERI Nájemní kritéria

Fasádní lešení PERI UP



| Podlahy | Popis | Instrukce | Fakturace | Typ |
|--|--|---|---|---|
|  | Kování <ul style="list-style-type: none"> ■ Praskliny v háčcích |  |  |  |
| | <ul style="list-style-type: none"> ■ Nelze zaručit bezpečnost při zvedání |  |  |  |
|  | Plastová páska <ul style="list-style-type: none"> ■ Řez v pásce |  |  |  |
| | <ul style="list-style-type: none"> ■ Chybí |  |  |  |

PERI Nájemní kritéria

Fasádní lešení PERI UP



Horizontála UH a UH Plus

Číslo

Popis

Číslo výrobku

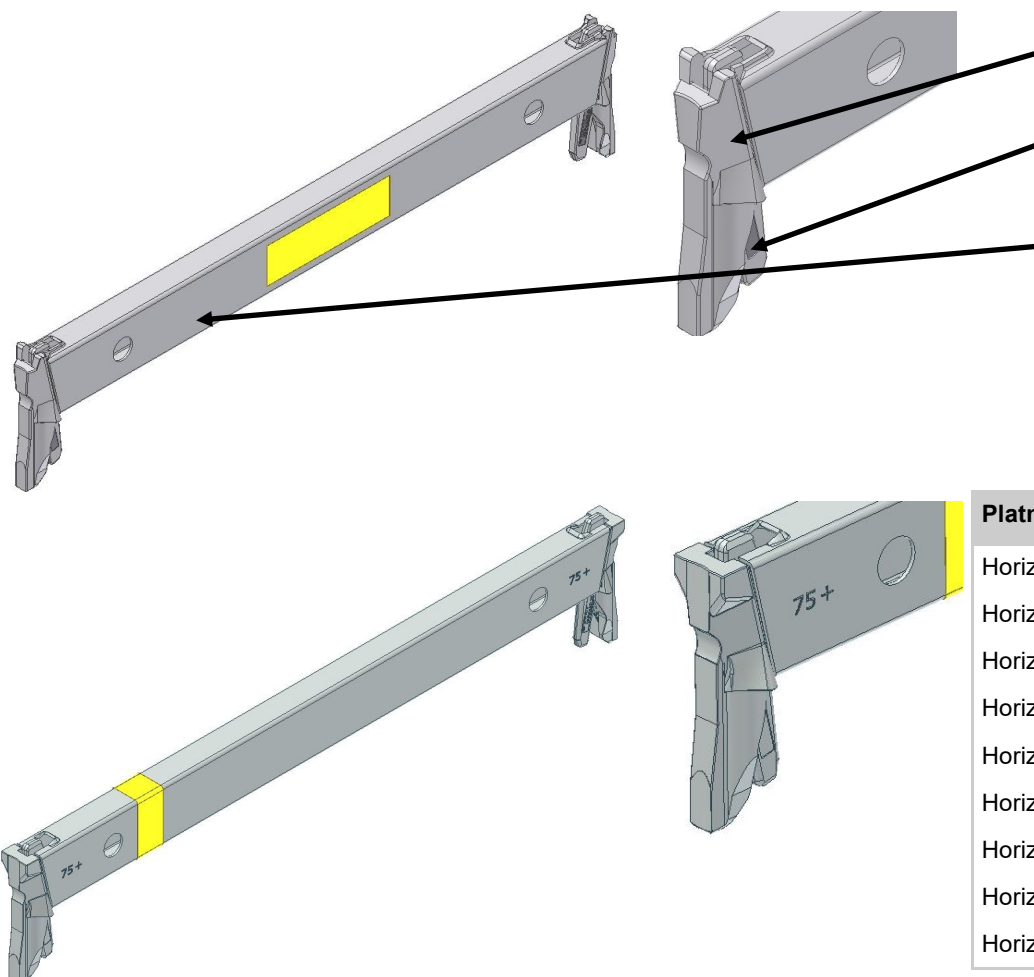

1

1

Hlava horizontály

2

2

Klínek

3

3

Profil

| Platné pro : | Číslo výrobku |
|--------------------------|---------------|
| Horizontála UH 25 Plus | 114613 |
| Horizontála UH 37,5 Plus | 125840 |
| Horizontála UH 50 Plus | 114595 |
| Horizontála UH 67 Plus | 129982 |
| Horizontála UH 72 Plus | 114124 |
| Horizontála UH 75 Plus | 114629 |
| Horizontála UH 100 Plus | 114632 |
| Horizontála UH 104 Plus | 114635 |
| Horizontála UH 125 Plus | 114638 |
| Horizontála UH 150 Plus | 114641 |
| Horizontála UH 175 Plus | 117032 |
| Horizontála UH 200 Plus | 114645 |
| Horizontála UH 225 Plus | 116356 |
| Horizontála UH 250 Plus | 114648 |
| Horizontála UH 300 Plus | 114651 |
| Horizontála UH 400 Plus | 114654 |

Platné pro :

Číslo výrobku

| | |
|--------------------|--------|
| Horizontála UH 72 | 100440 |
| Horizontála UH 104 | 100192 |
| Horizontála UH 150 | 100021 |
| Horizontála UH 200 | 100023 |
| Horizontála UH 250 | 100025 |
| Horizontála UH 300 | 100027 |
| Horizontála UH 400 | 100029 |
| Horizontála UH 75 | 100017 |
| Horizontála UH 100 | 101159 |

PERI Nájemní kritéria

Fasádní lešení PERI UP



Horizontála UH-2 | UHV-2

Číslo

Popis

Číslo výrobku

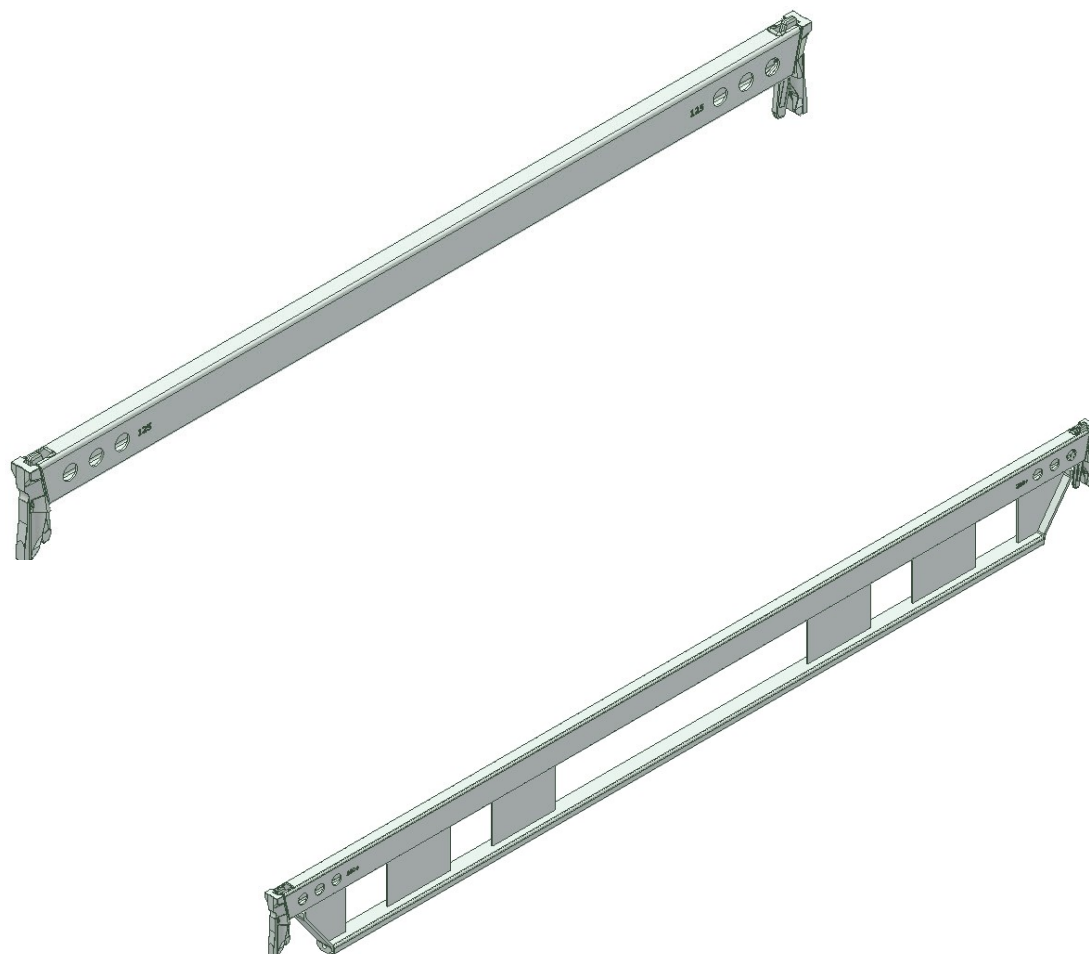

Platné pro:









Číslo výrobku

| | |
|-----------------------|--------|
| Horizontála UH-2 25 | 131995 |
| Horizontála UH-2 33 | 133900 |
| Horizontála UH-2 50 | 131998 |
| Horizontála UH-2 67 | 133903 |
| Horizontála UH-2 75 | 132213 |
| Horizontála UH-2 100 | 132004 |
| Horizontála UH-2 125 | 132007 |
| Horizontála UH-2 150 | 132010 |
| Horizontála UH-2 175 | 132013 |
| Horizontála UH-2 200 | 132016 |
| Horizontála UH-2 225 | 132019 |
| Horizontála UH-2 250 | 132025 |
| Horizontála UH-2 300 | 132022 |
| Horizontála UHV-2 150 | 137020 |
| Horizontála UHV-2 200 | 137025 |
| Horizontála UHV-2 250 | 137030 |
| Horizontála UHV-2 300 | 137035 |

PERI Nájemní kritéria

Fasádní lešení PERI UP



| UH Horizontála | Popis | Instrukce | Fakturace | Typ |
|--|--|---|--|--|
|  | <p>Lokálně promáčknutý profil</p> <ul style="list-style-type: none">■ Hrany nejsou zasaženy |  |  |  |
|  | <p>Poškozený klínový zámek Klínek chybí</p> |   |  |  |

PERI Nájemní kritéria

Fasádní lešení PERI UP



















| UH Horizontála | Popis | Instrukce | Fakturace | Typ |
|----------------|---|-----------|-----------|-----|
| | Promáčknuta hrana profilu | | | |
| | Promáčknutí na koncích horizontál | | | |
| | <ul style="list-style-type: none"> ■ Hrany nejsou zasaženy, bez prasklin v materiálu a klínek je funkční | | | |
| | <ul style="list-style-type: none"> ■ Hrany jsou zasaženy | | | |
| | <ul style="list-style-type: none"> ■ Praskliny v materiálu | | | |
| | <ul style="list-style-type: none"> ■ Nefunkční klínek | | | |

PERI Nájemní kritéria

Fasádní lešení PERI UP



| UH Horizontála | Popis | Instrukce | Fakturace | Typ | |
|--|---|---|--|--|---|
|  | Poškození děr v horizontále | | | | |
| | <ul style="list-style-type: none"> ■ Originální geometrie je zachována |  |  | 088244 |  |
| | <ul style="list-style-type: none"> ■ Originální geometrie je poškozena |   |  | |  |
| <ul style="list-style-type: none"> ■ Praskliny v materiálu |   |  | |  | |
|  | Profil ohnutý ve svislém směru |   |  |  | |

PERI Nájemní kritéria

Fasádní lešení PERI UP



| UH- Horizontála | Popis | Instrukce | Fakturace | Typ |
|-----------------|-------|-----------|-----------|-----|
|-----------------|-------|-----------|-----------|-----|

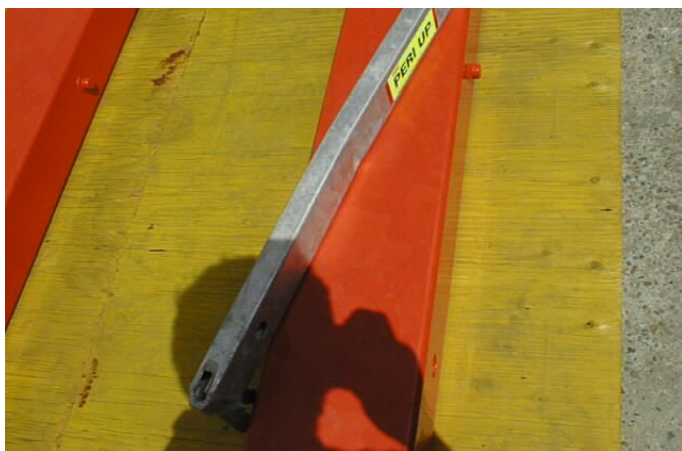

Ohnutá horizontála

- Hrany nejsou poškozeny
≤ povolený ohyb (l/300)



| Výrobek | Povolený ohyb |
|--------------------|---------------|
| Horizontála UH 25 | 3 mm |
| Horizontála UH 50 | 3 mm |
| Horizontála UH 75 | 3 mm |
| Horizontála UH 100 | 3 mm |
| Horizontála UH 125 | 4 mm |
| Horizontála UH 150 | 5 mm |
| Horizontála UH 200 | 7 mm |
| Horizontála UH 250 | 8 mm |
| Horizontála UH 300 | 10 mm |

- > povolený ohyb



PERI Nájemní kritéria

Fasádní lešení PERI UP



| UHV-2 Horizontála | Popis | Instrukce | Fakturace | Typ |
|-------------------|--------------------------------|-----------|-----------|-----|
| | Ohnuté výztuhy | | | |
| | ■ Lze narovnat | | | |
| | Ohnutý profil ve svislém směru | | | |
| | ■ Nelze narovnat | | | |

PERI Nájemní kritéria

Fasádní lešení PERI UP



| Základní Sloupek UVB Vertikální sloupek UVR Koncový sloupek UVH | Číslo | Popis | Číslo výrobku |
|---|-------|-------|---------------|
|---|-------|-------|---------------|

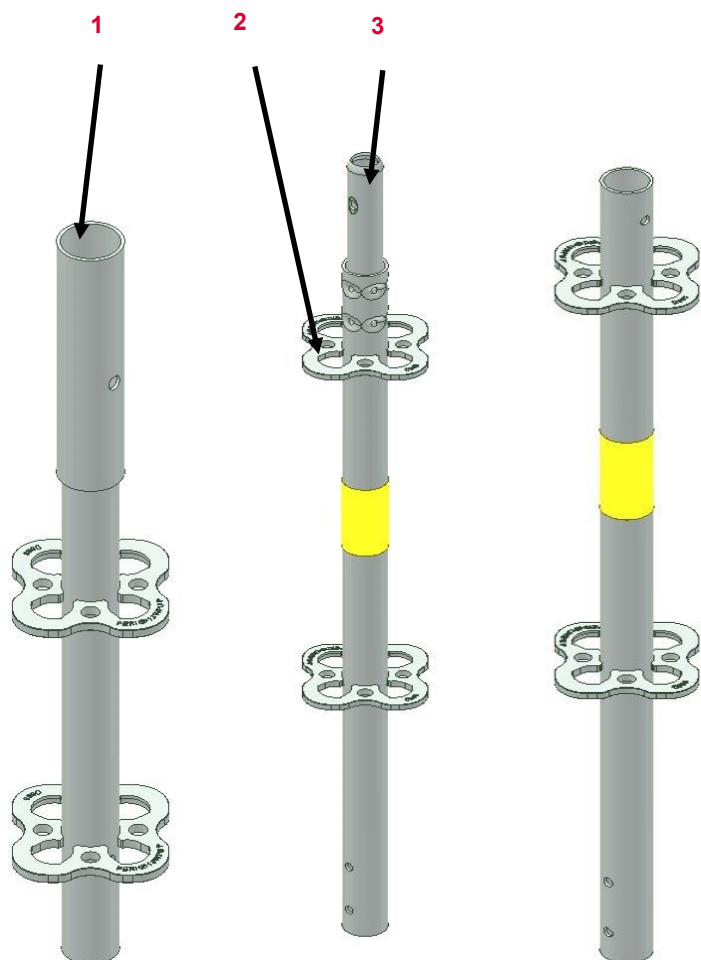

| | |
|---|---------|
| 1 | Spojení |
| 2 | Rozeta |
| 3 | Trn |

| Platné pro: | Číslo výrobku |
|----------------------------|---------------|
| Základní sloupek UVB 24 | 100014 |
| Základní sloupek UVB 49 | 117194 |
| Vertikální sloupek UVR 50 | 102859 |
| Vertikální sloupek UVR 100 | 101306 |
| Vertikální sloupek UVR 150 | 102860 |
| Vertikální sloupek UVR 200 | 100009 |
| Vertikální sloupek UVR 300 | 100012 |
| Vertikální sloupek UVR 400 | 100013 |
| Koncový sloupek UVH 50 | 101309 |
| Koncový sloupek UVH 100 | 100000 |
| Koncový sloupek UVH 125 | 117195 |
| Koncový sloupek UVH 150 | 100003 |
| Koncový sloupek UVH 200 | 100005 |
| Koncový sloupek UVH 250 | 100007 |

PERI Nájemní kritéria

Fasádní lešení PERI UP



Koncový sloupek UVH-2

Číslo

Popis

Číslo výrobku



Platné pro:

Číslo výrobku

Koncový sloupek UVH-2 50

132123

Koncový sloupek UVH-2 100

132194

Koncový sloupek UVH-2 125

132196

Koncový sloupek UVH-2 150

132198

Koncový sloupek UVH-2 200

132200

















Koncový sloupek UVH-2 250

132202

PERI Nájemní kritéria

Fasádní lešení PERI UP



| Sloupky | Popis | Instrukce | Fakturace | Typ |
|--|-------------------------|---|--|--|
|  | Ohnutá rozeta | | | |
| | ■ ≤ 20 mm |   |  |  |
| | ■ > 20 mm |   |  |  |
| | ■ Praskliny v rozetě |   |  |  |
|  | Silné znečištění |  |  |  |

PERI Nájemní kritéria

Fasádní lešení PERI UP



| Sloupky | Popis | Instrukce | Fakturace | Typ |
|---------|-------|-----------|-----------|-----|
|---------|-------|-----------|-----------|-----|



Ohnutý sloupek UVR

- > Povolený ohyb (L/500)



| Výrobek | Povolený ohyb |
|---------|---------------|
| UVR 50 | 5 mm |
| UVR 100 | 5 mm |
| UVR 150 | 5 mm |
| UVR 200 | 5 mm |
| UVR 300 | 6 mm |
| UVR 400 | 8 mm |



Trn nebo spojení je ohnuté

- Nelze sestavit



- Praskliny v materiálu



PERI Nájemní kritéria

Fasádní lešení PERI UP



Patka UJB | Kloubová patka UJS | Vřeteno UJK

Číslo Popis Číslo výrobku

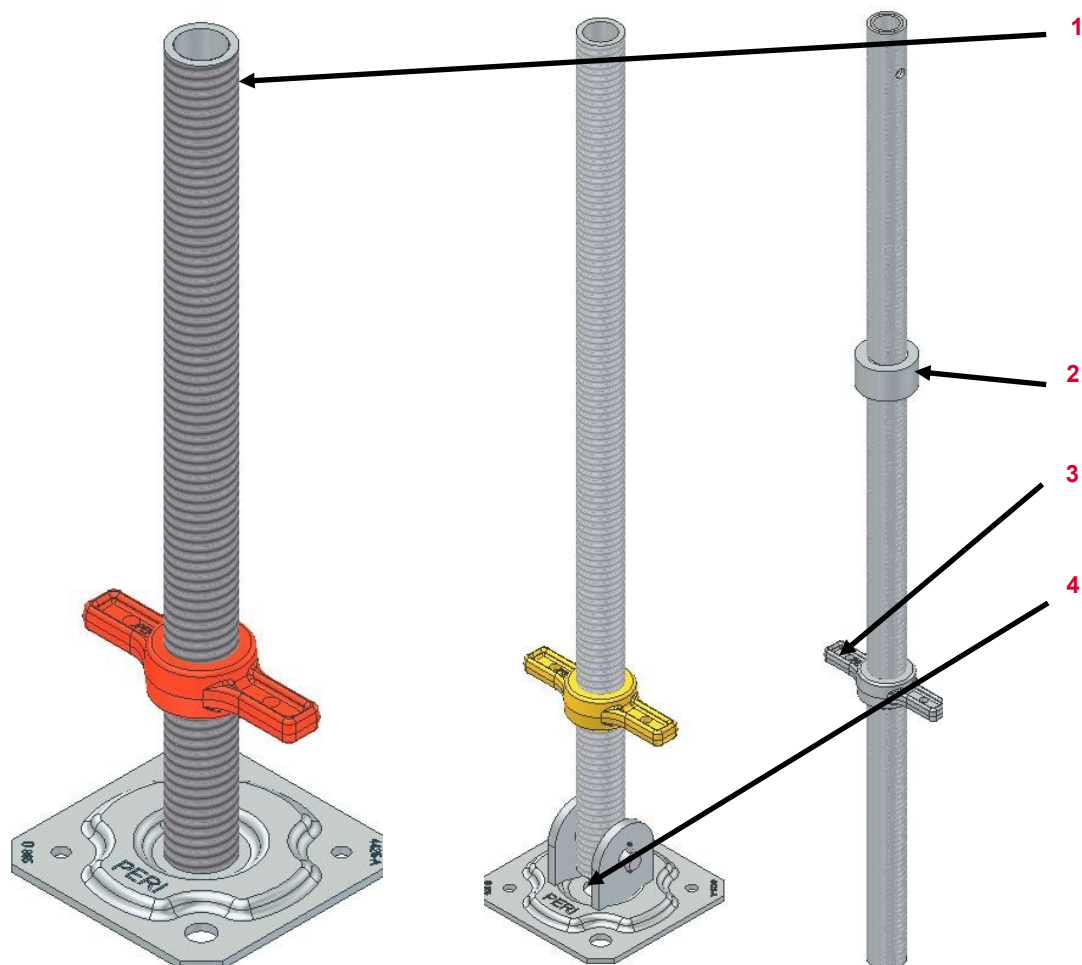











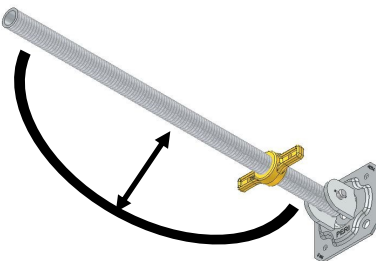



| | | |
|---|---------------------|--------|
| 1 | Vřeteno | |
| 2 | Navařovací matice | |
| 3 | Utahovací matice 38 | 710071 |
| 4 | Patka | |

| Platné pro | Číslo výrobku |
|------------------------------|---------------|
| Patka UJB 38-36/17 | 116762 |
| Patka UJB 38-36/30 | 100411 |
| Patka UJB 38-36/55 | 100242 |
| Kloubová patka UJS 38-80 /50 | 100159 |
| Vřeteno UJK 38-110/41 | 111072 |

PERI Nájemní kritéria

Fasádní lešení PERI UP

















| Vřetena | Popis | Instrukce | Fakturace | Typ |
|---|--|--|---|--|
|  | Ohnuté vřeteno |  |  |  |
|  | Poškozená utahovací matice |  |  |  |
|  | <p>Ohnutá patka</p> <ul style="list-style-type: none"> ■ Lze narovnat ■ Nelze narovnat ■ Prasklý svár |   |  088244  |   |

PERI Nájemní kritéria

Fasádní lešení PERI UP











| Patka UJP (100244) | Popis | Instrukce | Fakturace | Typ | |
|--|--|--|--|--|---|
|  | Ohnutá patka | <ul style="list-style-type: none"> ■ Lze Narovnat |  |  |  |
| | <ul style="list-style-type: none"> ■ Nelze narovnat |  |  |  | |
| | <ul style="list-style-type: none"> ■ Prasklý svár |  |  |  | |
|  | Ohnutá trubka |  |  |  | |

PERI Nájemní kritéria

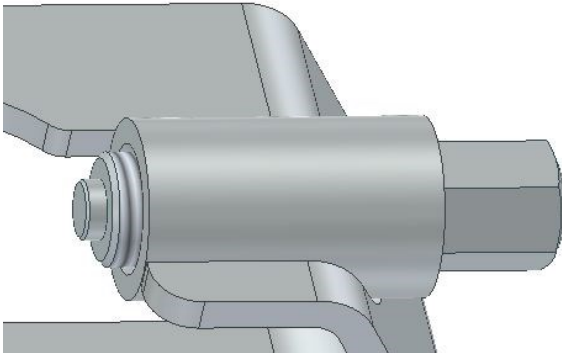
Fasádní lešení PERI UP













| Pojistka UJS (100863) | Popis | Instrukce | Fakturace | Typ |
|---|---|--|--|--|
|  | Ohnutá pojistka ■ Nefunkční |  |  |  |
|  | Poškozený závit (nelze utáhnout) |  |  |  |

PERI Nájemní kritéria

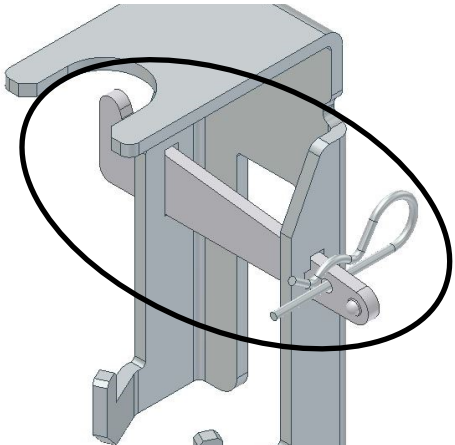
Fasádní lešení PERI UP



| Pojistka hlavy UJH (109563) | Popis | Instrukce | Fakturace | Typ |
|--|---|--|--|--|
|  | <p>Ohnutý výrobek</p> <ul style="list-style-type: none"> ■ Lze srovnat ■ Nelze srovnat |   |   |   |
|  | <p>Klín chybí / poškozený</p> |  |  |  |

PERI Nájemní kritéria

Fasádní lešení PERI UP



Diagonála s háčkem UBL



| Číslo | Popis | Číslo výrobku |
|-------|----------------|-----------------|
| 1 | Háček | |
| 2 | Trubka | |
| 3 | Upínací vložka | 710910 131386 |
| 4 | Pojistka | 710123 |

PERI Nájemní kritéria

Fasádní řešení PERI UP



| Výrobek | Číslo výrobku |
|--------------------------------|---------------|
| Diagonála s háčkem UBL 100/50 | 115156 |
| Diagonála s háčkem UBL 150/50 | 107867 |
| Diagonála s háčkem UBL 200/50 | 104391 |
| Diagonála s háčkem UBL 225/50 | 130282 |
| Diagonála s háčkem UBL 300/50 | 104762 |
| Diagonála s háčkem UBL 104/100 | 106613 |
| Diagonála s háčkem UBL 150/100 | 100055 |
| Diagonála s háčkem UBL 200/100 | 100059 |
| Diagonála s háčkem UBL 225/100 | 130283 |
| Diagonála s háčkem UBL 250/100 | 100063 |
| Diagonála s háčkem UBL 300/100 | 100067 |
| Diagonála s háčkem UBL 100/150 | 115513 |
| Diagonála s háčkem UBL 150/150 | 102846 |
| Diagonála s háčkem UBL 200/150 | 102862 |

| Výrobek | Číslo výrobku |
|--------------------------------|---------------|
| Diagonála s háčkem UBL 250/150 | 102861 |
| Diagonála s háčkem UBL 300/150 | 104766 |
| Diagonála s háčkem UBL 100/200 | 115157 |
| Diagonála s háčkem UBL 150/200 | 100057 |
| Diagonála s háčkem UBL 175/200 | 109034 |
| Diagonála s háčkem UBL 200/200 | 100061 |
| Diagonála s háčkem UBL 225/200 | 117689 |
| Diagonála s háčkem UBL 250/200 | 100065 |
| Diagonála s háčkem UBL 300/200 | 100069 |
| | |
| | |
| | |
| | |
| | |
| | |

PERI Nájemní kritéria

Fasádní řešení PERI UP













| Výrobek | Číslo výrobku |
|-------------------------|---------------|
| Diagonála UBL-2 100/50 | 132771 |
| Diagonála UBL-2 150/50 | 132779 |
| Diagonála UBL-2 200/50 | 132789 |
| Diagonála UBL-2 225/50 | 132797 |
| Diagonála UBL-2 300/50 | 132827 |
| Diagonála UBL-2 100/100 | 132773 |
| Diagonála UBL-2 150/100 | 132781 |
| Diagonála UBL-2 200/100 | 132791 |
| Diagonála UBL-2 225/100 | 132808 |
| Diagonála UBL-2 250/100 | 132812 |
| Diagonála UBL-2 300/100 | 132829 |
| Diagonála UBL-2 100/150 | 132775 |
| Diagonála UBL-2 150/150 | 132783 |
| Diagonála UBL-2 200/150 | 132793 |

| Výrobek | Číslo výrobku |
|-------------------------|---------------|
| Diagonála UBL-2 250/150 | 132814 |
| Diagonála UBL-2 300/150 | 132831 |
| Diagonála UBL-2 100/200 | 132777 |
| Diagonála UBL-2 150/200 | 132785 |
| Diagonála UBL-2 175/200 | 132787 |
| Diagonála UBL-2 200/200 | 132795 |
| Diagonála UBL-2 225/200 | 132810 |
| Diagonála UBL-2 250/200 | 132816 |
| Diagonála UBL-2 300/200 | 132833 |
| | |
| | |
| | |
| | |
| | |
| | |
| | |
| | |

PERI Nájemní kritéria

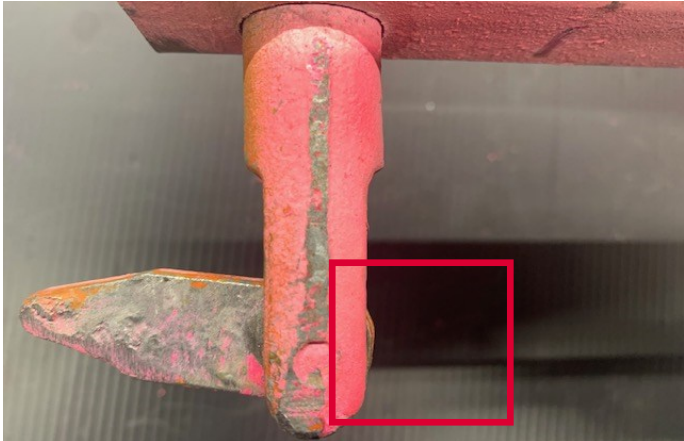
Fasádní lešení PERI UP



| Horizontály UBL | Popis | Instrukce | Fakturace | Typ |
|--|---|--|--|--|
|  | <p>Pojistka</p> <ul style="list-style-type: none"> ■ Chybí ■ Poškozená | <ul style="list-style-type: none">  710910 (Upínací vložka) nebo 131386 (Pružný kolík) 710123 (Pojistka)  710910 (Upínací vložka) 710123 (Pojistka)) | <ul style="list-style-type: none">   | <ul style="list-style-type: none">   |
|  | <p>Neoriginální pojistka pro -UBL</p> | <ul style="list-style-type: none">  710910 (Upínací vložka) nebo 131386 (Pružný kolík) 710123 (Pojistka) | <ul style="list-style-type: none">  | <ul style="list-style-type: none">  |

PERI Nájemní kritéria

Fasádní lešení PERI UP



| Diagonály UBL | Popis | Instrukce | Fakturace | Typ |
|---|---|---|--|--|
|  | Ohnutá Diagonála ■ > 5 mm (l/500) |   |  |  |
|  | Promáčknutý profil ■ $\varnothing > 3$ cm |   |  |  |

PERI Nájemní kritéria

Fasádní lešení PERI UP



Styčnická diagonála UBK | UBK-2

| Číslo | Popis | Číslo výrobku |
|-------|-------|---------------|
|-------|-------|---------------|

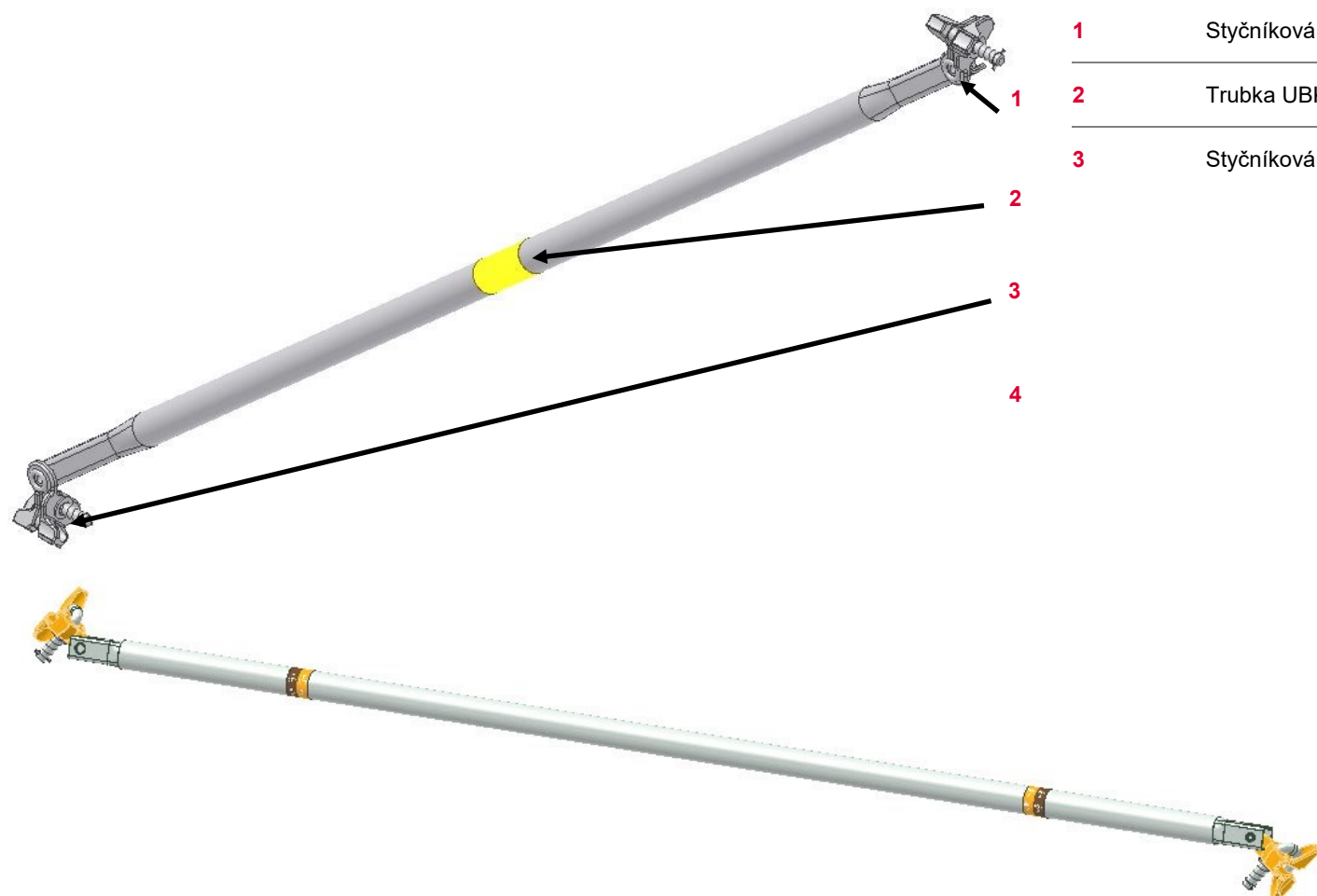

| | | |
|---|---------------------------|--|
| 1 | Styčnická hlava UBK pravá | |
| 2 | Trubka UBK | |
| 3 | Styčnická hlava UBK levá | |

PERI Nájemní kritéria

Fasádní lešení PERI UP



| Výrobek | Číslo výrobku |
|-----------------------------------|---------------|
| Styčnicková diagonála UBK 72/100 | 106969 |
| Styčnicková diagonála UBK 104/100 | 100977 |
| Styčnicková diagonála UBK 125/100 | 115354 |
| Styčnicková diagonála UBK 150/100 | 100981 |
| Styčnicková diagonála UBK 200/100 | 100985 |
| Styčnicková diagonála UBK 250/100 | 100989 |
| Styčnicková diagonála UBK 300/100 | 100993 |
| Styčnicková diagonála UBK 150/150 | 100973 |
| Styčnicková diagonála UBK 200/150 | 106630 |
| Styčnicková diagonála UBK 250/150 | 106624 |

| Výrobek | Číslo výrobku |
|-----------------------------------|---------------|
| Styčnicková diagonála UBK 72/200 | 100969 |
| Styčnicková diagonála UBK 75/200 | 124170 |
| Styčnicková diagonála UBK 100/200 | 112926 |
| Styčnicková diagonála UBK 104/200 | 100840 |
| Styčnicková diagonála UBK 125/200 | 112765 |
| Styčnicková diagonála UBK 150/200 | 100572 |
| Styčnicková diagonála UBK 200/200 | 100573 |
| Styčnicková diagonála UBK 250/200 | 100574 |
| Styčnicková diagonála UBK 300/200 | 100575 |

PERI Nájemní kritéria

Fasádní lešení PERI UP











| Výrobek | Číslo výrobku |
|-------------------------|---------------|
| Diagonála UBK-2 125/100 | 133424 |
| Diagonála UBK-2 150/100 | 133430 |
| Diagonála UBK-2 200/100 | 133439 |
| Diagonála UBK-2 250/100 | 133448 |
| Diagonála UBK-2 300/100 | 133457 |
| Diagonála UBK-2 150/150 | 133433 |
| Diagonála UBK-2 200/150 | 133442 |
| Diagonála UBK-2 250/150 | 133451 |
| Diagonála UBK-2 300/150 | 133460 |

| Výrobek | Číslo výrobku |
|-------------------------|---------------|
| Diagonála UBK-2 75/200 | 133418 |
| Diagonála UBK-2 100/200 | 133421 |
| Diagonála UBK-2 125/200 | 133427 |
| Diagonála UBK-2 150/200 | 133436 |
| Diagonála UBK-2 200/200 | 133445 |
| Diagonála UBK-2 250/200 | 133454 |
| Diagonála UBK-2 300/200 | 133463 |

PERI Nájemní kritéria

Fasádní lešení PERI UP



| UBK / UBK-2 | Popis | Instrukce | Fakturace | Typ |
|--|---|--|--|--|
|  | Nýťový spoj styčnickové hlavy je poškozen |  |  |  |
|  | Styčnicková hlava chybí |  |  |  |

PERI Nájemní kritéria

Fasádní lešení PERI UP



Horizontální diagonála UBH | UBH Flex

| Číslo | Popis | Číslo výrobku |
|-------|-------|---------------|
|-------|-------|---------------|

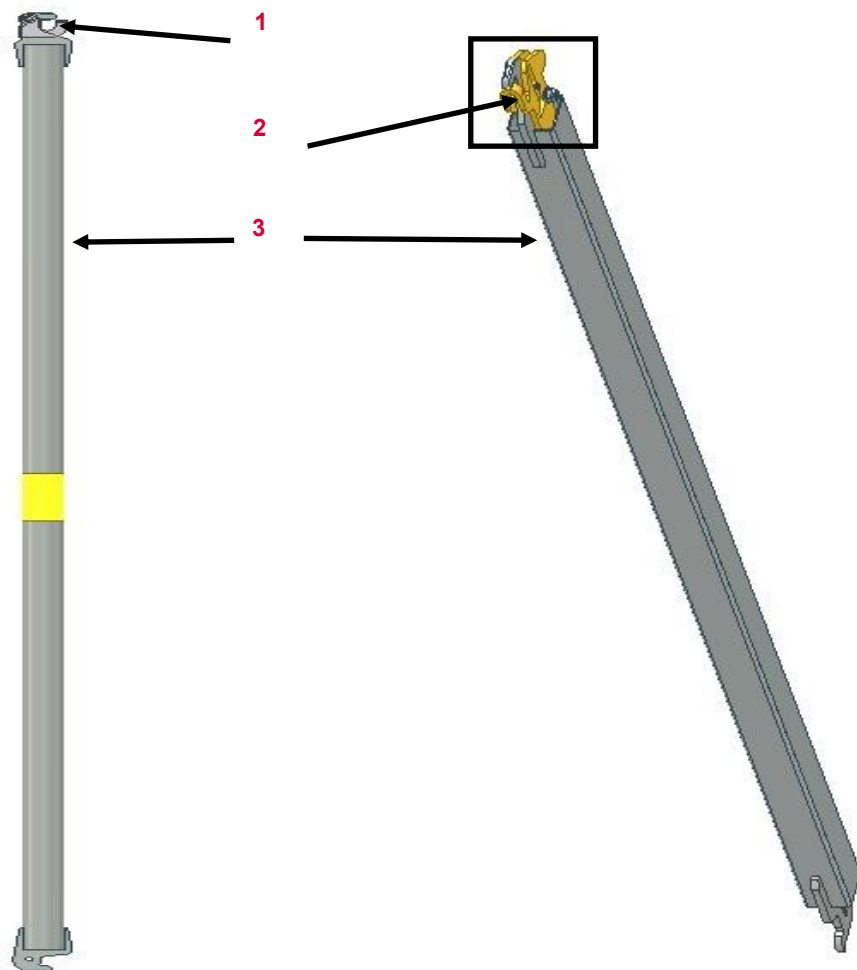

| | | |
|---|----------------|--------|
| 1 | Západka UBH | |
| 2 | Čelist UBH | 114874 |
| 3 | Trubka | |
| 4 | Šroub M 8x35 | 114862 |
| 5 | Upínací vložka | 780807 |
| 6 | Matice | 114861 |

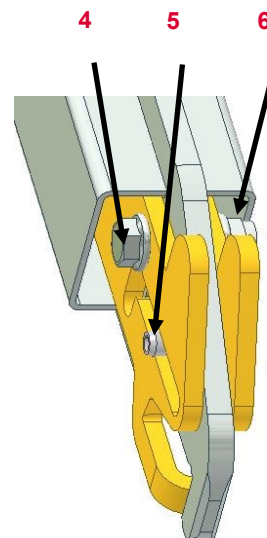

PERI Nájemní kritéria

Fasádní lešení PERI UP











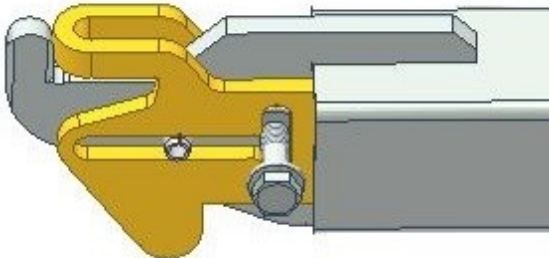

| Výrobek | Číslo výrobku |
|---|---------------|
| Horizontální diagonála UBH 150/150 | 100042 |
| Horizontální diagonála UBH 200/150 | 107815 |
| Horizontální diagonála UBH 250/150 | 106931 |
| Horizontální diagonála UBH 300/150 | 100051 |
| Horizontální diagonála UBH 200/200 | 100047 |
| Horizontální diagonála UBH 250/200 | 104356 |
| Horizontální diagonála UBH 300/200 | 123483 |
| Horizontální diagonála UBH 250/250 | 100049 |
| Horizontální diagonála UBH 300/300 | 100053 |
| Horizontální diagonála UBH FLEX 250/75 | 114896 |
| Horizontální diagonála UBH FLEX 300/75 | 114900 |
| Horizontální diagonála UBH FLEX 100/100 | 114818 |
| Horizontální diagonála UBH FLEX 150/100 | 114821 |
| Horizontální diagonála UBH FLEX 200/100 | 114820 |

| Výrobek | Číslo výrobku |
|---|---------------|
| Horizontální diagonála UBH FLEX 250/100 | 114819 |
| Horizontální diagonála UBH FLEX 300/100 | 114892 |
| Horizontální diagonála UBH FLEX 125/125 | 114904 |
| Horizontální diagonála UBH FLEX 150/125 | 114908 |
| Horizontální diagonála UBH FLEX 250/125 | 114996 |
| Horizontální diagonála UBH FLEX 150/150 | 114912 |
| Horizontální diagonála UBH FLEX 200/200 | 114916 |
| Horizontální diagonála UBH FLEX 250/200 | 114920 |
| Horizontální diagonála UBH FLEX 300/200 | 114924 |
| Horizontální diagonála UBH FLEX 250/250 | 114928 |
| Horizontální diagonála UBH FLEX 300/250 | 114932 |
| Horizontální diagonála UBH FLEX 300/300 | 114936 |
| Horizontální diagonála UBH FLEX 200/150 | 124097 |
| Horizontální diagonála UBH FLEX 250/150 | 124101 |
| Horizontální diagonála UBH FLEX 300/150 | 124105 |

PERI Nájemní kritéria

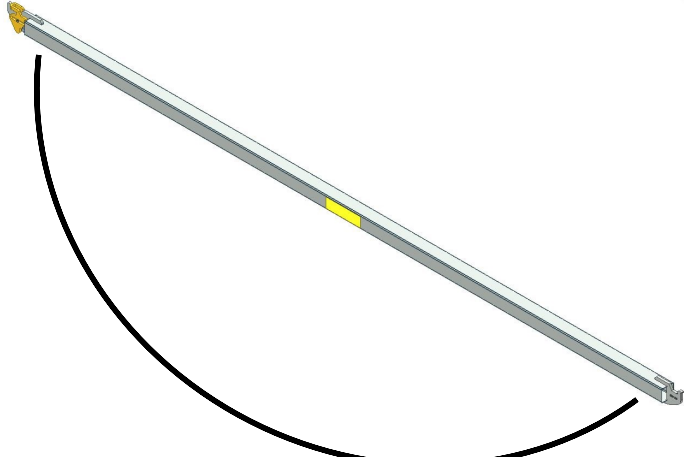
Fasádní lešení PERI UP















| Horizontální diagonála UBH | Popis | Instrukce | Fakturace | Typ |
|---|--|--|--|--|
|  | <p>Západka Čelist nelze použít</p> <ul style="list-style-type: none"> ■ UBH ■ UBH Flex | <ul style="list-style-type: none">   | <ul style="list-style-type: none">   | <ul style="list-style-type: none">   |
|  | <p>Ohnutá trubka</p> <ul style="list-style-type: none"> ■ < 5 mm (l/500) | <ul style="list-style-type: none">   | <ul style="list-style-type: none">  | <ul style="list-style-type: none">  |

PERI Nájemní kritéria

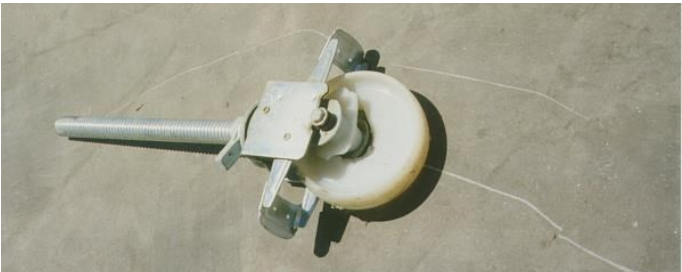
Fasádní lešení PERI UP



| Pojezdové kolečko UEW (101858 101860) | Popis | Instrukce | Fakturace | Typ |
|---|---|---|---|---|
|  | Uříznuté ohnuté vřeteno <ul style="list-style-type: none"> ■ Zbývající délka > 150 mm ■ Zbývající délka < 150 mm |  Odstraňte matici a použijte jako kolečko s pojezdem (Nutno překnihovat) |  |  |
| |  | Zlomené vřeteno |   |  |
|  | Zlomené kolo Zatíženo více než je povoleno |   |  |  |

PERI Nájemní kritéria

Fasádní lešení PERI UP



| Pojzdové kolečko UEW (101858 101860) | Popis | Instrukce | Fakturace | Typ |
|--|-------|-----------|-----------|-----|
|--|-------|-----------|-----------|-----|



Poškozená matice



Nefunkční brzda



PERI Nájemní kritéria

Fasádní lešení PERI UP



Příhradový nosník ocelový ULS | hliníkový ULA















| Číslo | Popis | Číslo výrobku |
|-------|-----------|---------------|
| 1 | Pásnice | |
| 2 | Stojna | |
| 3 | Diagonála | |

| Platné pro: | Číslo výrobku |
|-------------------------------------|---------------|
| Příhradový nosník oc. ULS 50/425 | 100330 |
| Příhradový nosník oc. ULS 50/525 | 100336 |
| Příhradový nosník oc. ULS 50/625 | 100339 |
| Příhradový nosník oc. ULS 70/525 | 100185 |
| Příhradový nosník oc. ULS 70/625 | 100183 |
| Příhradový nosník oc. ULS 70/825 | 100852 |
| Příhradový nosník Alu ULA 50/425 HD | 101656 |
| Příhradový nosník Alu ULA 50/525 HD | 101657 |
| Příhradový nosník Alu ULA 50/625 HD | 101658 |
| Příhradový nosník Alu ULA 50/825 HD | 101659 |

PERI Nájemní kritéria

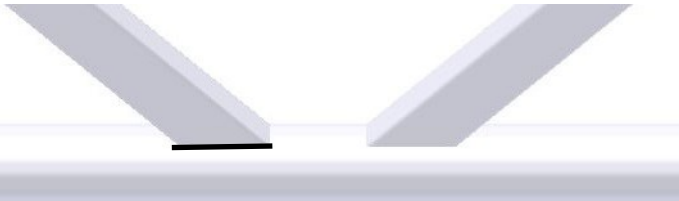
Fasádní lešení PERI UP



| Příhradový nosník | Popis | Instrukce | Fakturace | Typ | | | | | | |
|---|--|---|---|---|-------|---------------|-----|------|-----|-------|
|  | Ohnutý Příhradový nosník ■ > Povolенý ohyb (L/500) |  |  |  | | | | | | |
| | <table border="1"> <thead> <tr> <th>Délka</th> <th>Povolенý ohyb</th> </tr> </thead> <tbody> <tr> <td>425</td> <td>9 mm</td> </tr> <tr> <td>525</td> <td>11 mm</td> </tr> <tr> <td>625</td> <td>13 mm</td> </tr> <tr> <td>825</td> <td>17mm</td> </tr> </tbody> </table> | | | | Délka | Povolенý ohyb | 425 | 9 mm | 525 | 11 mm |
| Délka | Povolенý ohyb | | | | | | | | | |
| 425 | 9 mm | | | | | | | | | |
| 525 | 11 mm | | | | | | | | | |
| 625 | 13 mm | | | | | | | | | |
| 825 | 17mm | | | | | | | | | |
|  | Ohnutá diagonála |  |  |  | | | | | | |
|  | Prasklý svár |  |  |  | | | | | | |

PERI Nájemní kritéria

Fasádní lešení PERI UP



| Žebřík Flex UEL (126318) | Popis | Instrukce | Fakturace | Typ |
|--------------------------|-------|-----------|-----------|-----|
|--------------------------|-------|-----------|-----------|-----|



Závěs ohnutý / zlomený

■ Bez poškození přilehlých částí žebříku



■ S poškozením přilehlých částí žebříku

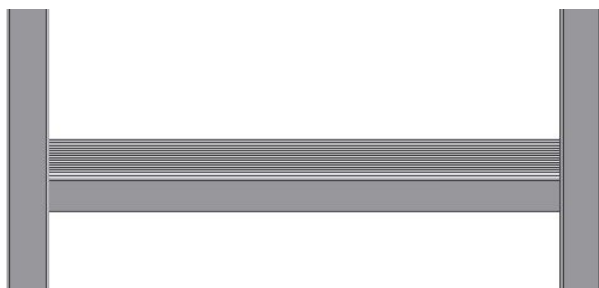

Ohnutý schod



Prasklý svár

■ Bez poškození žebříku nebo schodu



■ S poškozením žebříku nebo schodu



PERI Nájemní kritéria

Fasádní lešení PERI UP



| Jezdec ULB 50/70 (100529) | Popis | Instrukce | Fakturace | Typ |
|---------------------------|---|--|-----------|-----|
| | Trn ohnutý / promáčklý | <ul style="list-style-type: none"> ■ Nelze připojit | | |
| | <ul style="list-style-type: none"> ■ Nebo $d > 3 \text{ mm}$ | | | |
| | Trubka ohnutá promáčklá | <ul style="list-style-type: none"> ■ $\varnothing > 3 \text{ cm}$ | | |
| | <ul style="list-style-type: none"> ■ $t > 3 \text{ mm}$ | | | |
| | Ohnutá styčná plocha | <ul style="list-style-type: none"> ■ Lze srovnat | | |
| | <ul style="list-style-type: none"> ■ Nelze srovnat | | | |

PERI Nájemní kritéria

Fasádní lešení PERI UP



| Podlahová spona UDC (111011) | Popis | Instrukce | Fakturace | Typ |
|------------------------------|---|-----------|-----------|-----|
| | Ohnuté kleště | | | |
| | <ul style="list-style-type: none"> ■ Lze srovnat | | | |
| | <ul style="list-style-type: none"> ■ Nelze srovnat | | | |
| | Ohnutý klín nepohyblivý | | | |

PERI Nájemní kritéria

Fasádní lešení PERI UP



Kotevní háček UWT

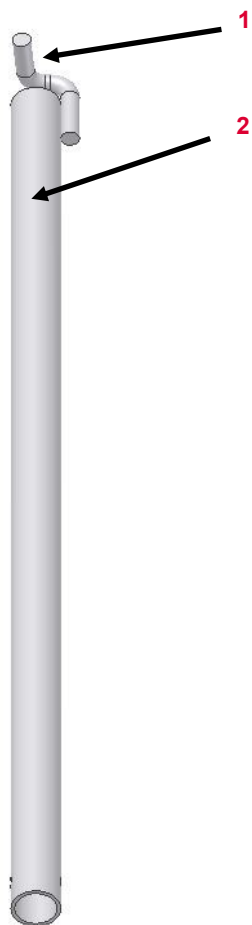

| Číslo | Popis | Číslo výrobku |
|-------|-------|---------------|
|-------|-------|---------------|

- | | |
|---|--------|
| 1 | Hák |
| 2 | Trubka |

Platné pro:

Číslo výrobku

| | |
|-----------------------|--------|
| Kotevní háček UWT 45 | 100088 |
| Kotevní háček UWT 110 | 100091 |
| Kotevní háček UWT 140 | 100093 |
| Kotevní háček UWT 170 | 102951 |
| Kotevní háček UWT 220 | 102954 |
| Kotevní háček UWT 270 | 102957 |

PERI Nájemní kritéria

Fasádní lešení PERI UP



| Kotevní sloupek UWT | Popis | Instrukce | Fakturace | Typ |
|---------------------|-------|-----------|-----------|-----|
|---------------------|-------|-----------|-----------|-----|



Rezavý hák

- Bez poškození sváru



Odstraňte rez a obnovte pozinkování



Ohnutý výrobek

- > povolený ohyb (l/500)



| Výrobek | Povolený ohyb |
|---------|---------------|
| UWT 45 | 3,0 mm |
| UWT 110 | 3,0 mm |
| UWT 140 | 3,0 mm |
| UWT 170 | 4,0 mm |
| UWT 220 | 4,0 mm |
| UWT 270 | 5,0 mm |

PERI Nájemní kritéria

Fasádní lešení PERI UP



| Spojovací zarážka pro UH (105824) | Popis | Instrukce | Fakturace | Typ | |
|-----------------------------------|-------------------------------|-----------|-----------------------------------|-----|-----------------------------------|
| | Šroub s klad. Hlavou Matice | | 710702 (Šroub) 710340 (Matice) | | |
| | ■ Chybí | | | | |
| | Klín chybí | | | | |
| | ■ Nelze použít | | | | 710702 (Šroub) 710340 (Matice) |

PERI Nájemní kritéria

Fasádní lešení PERI UP



| Spojková rozeta UEV 90 180 (126453 116306) | Popis | Instrukce | Fakturace | Typ |
|--|-------|-----------|-----------|-----|
|--|-------|-----------|-----------|-----|

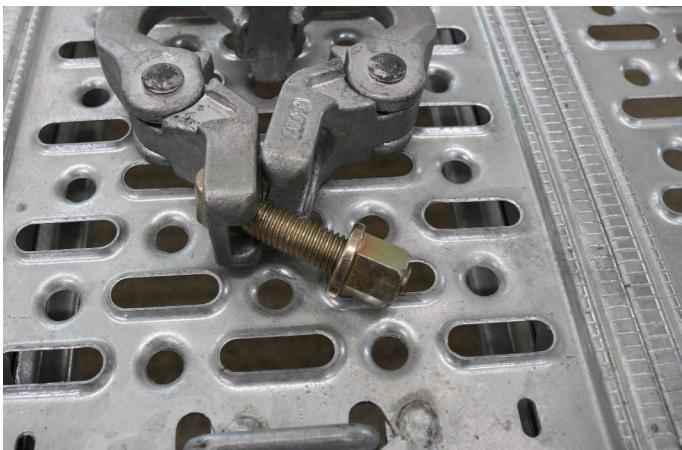

Šroub s klad. Hlavou | Matice

■ Chybí



117475 (Šroub)
118091 (Matice)



■ Nelze použít



117475 (Šroub)
118091 (Matice)



Spojení není pohyblivé

■ Poškozeno opotřebením (REZ)



■ Poškozeno silou (Ohnutí)



PERI Nájemní kritéria

Fasádní lešení PERI UP



| Přírubová spojka UEC (113726) | Popis | Instrukce | Fakturace | Typ |
|-------------------------------|---------------------------------------|-----------------------------------|-----------|-----|
| | Ohnutý háček | | | |
| | ■ Lze srovnat | | | |
| | ■ Nelze srovnat | | | |
| | ■ Praskliny ve svárech nebo materiálu | | | |
| | Šroub s klad. Hlavou Matice | | | |
| | ■ Chybí | 710702 (Šroub) 710340 (Matice) | | |
| | ■ Nelze použít | 710702 (Šroub) 710340 (Matice) | | |

PERI Nájemní kritéria

Fasádní lešení PERI UP



Podlaha s průlezem UAW –L

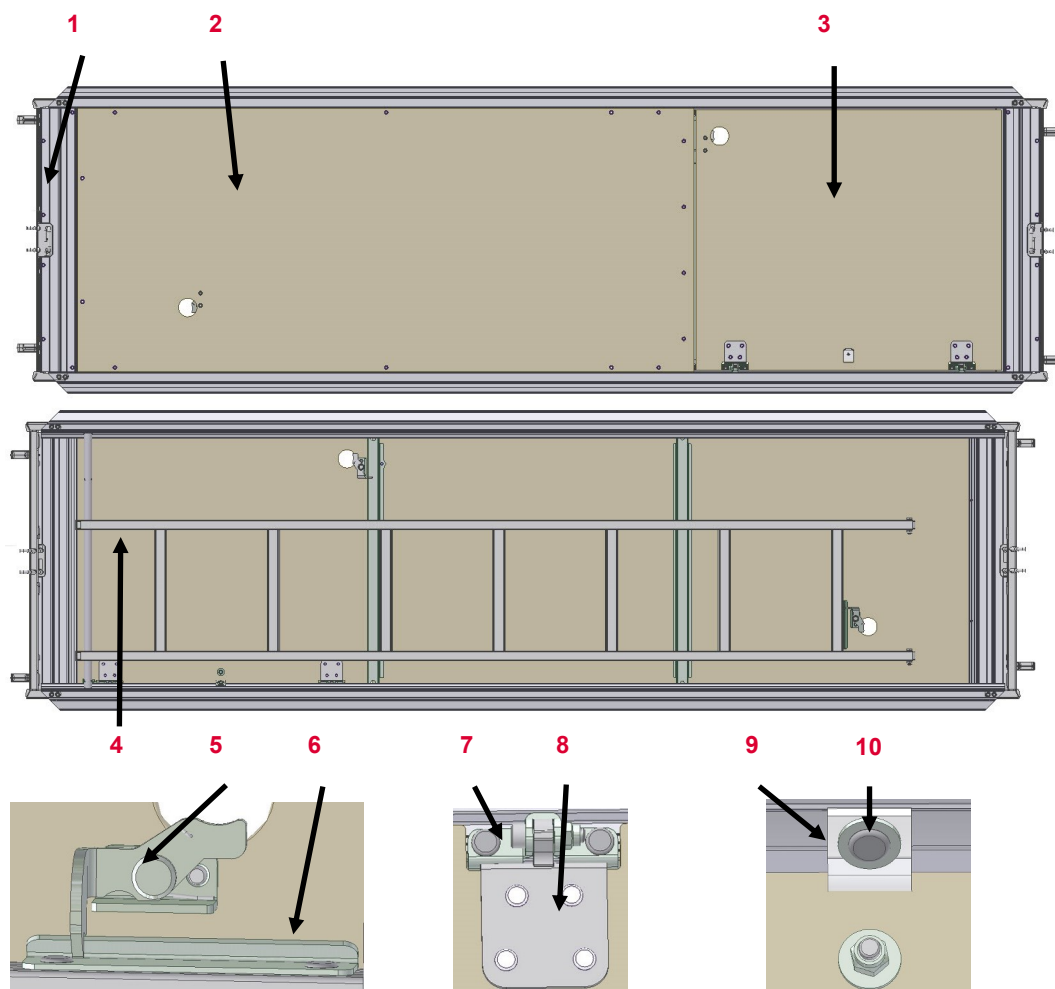

| Číslo | Popis | Číslo výrobku |
|-------|---------------------|---------------|
| 1 | Kování | 132971 |
| 2 | Podlaha | |
| 3 | Průlez | 132977 |
| 4 | Žebřík | 133158 |
| 5 | Západka pro EAW - 2 | 132598 |
| 6 | Profil západky | 132588 |
| 7 | Pant | 132586 |
| 8 | Pant Druhá Část | 132606 |
| 9 | Guma EPDM 65 | 132587 |
| 10 | Nýt | 722318 |

| Platné pro: | Číslo výrobku |
|---------------------------------|---------------|
| Podlaha s průlezem UAW 75x150-L | 134046 |
| Podlaha s průlezem UAW 75x200-L | 132996 |
| Podlaha s průlezem UAW 75x250-L | 130334 |
| Podlaha s průlezem UAW 75x300-L | 133309 |

PERI Nájemní kritéria

Fasádní lešení PERI UP



Podlaha s průřezem UAA-L

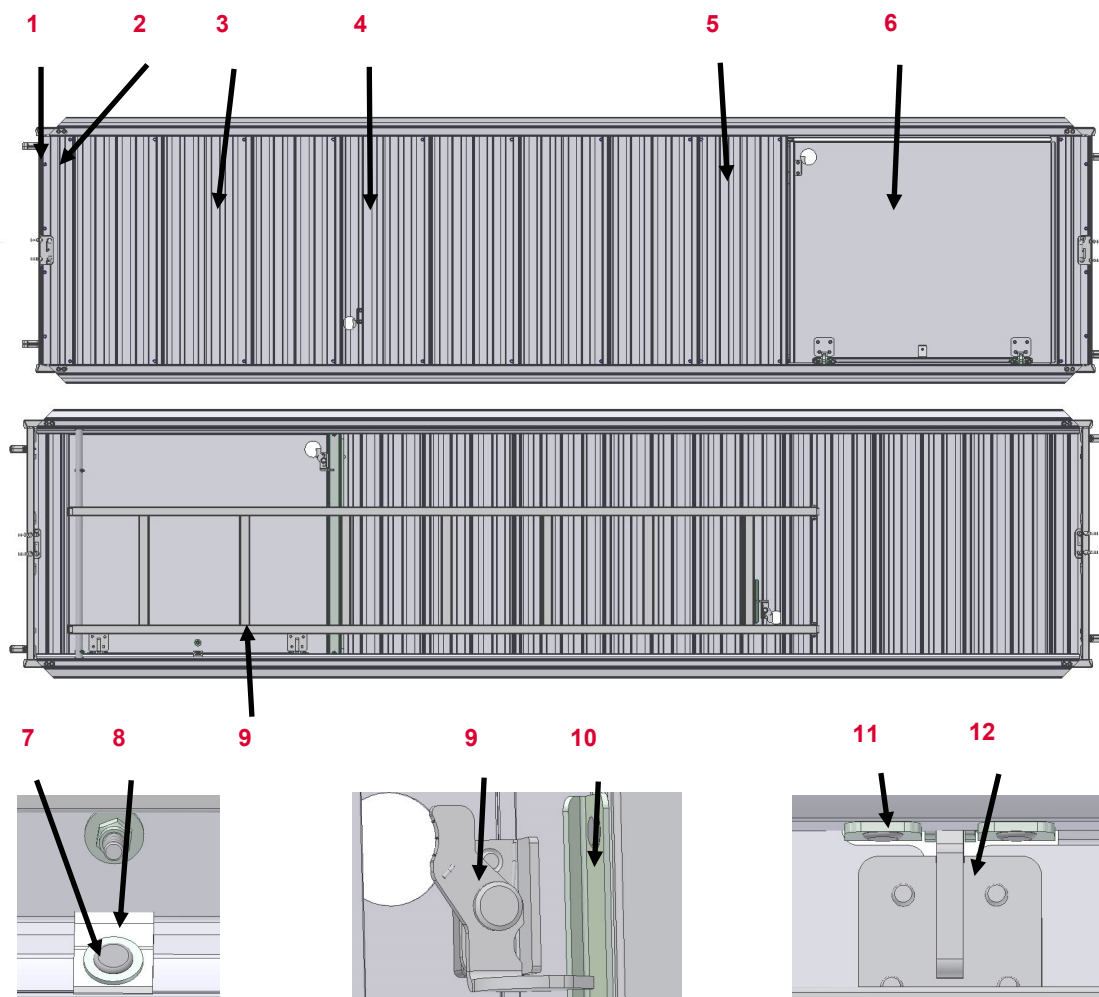

| Číslo | Popis | Číslo výrobku |
|-------|---------------------|---------------|
| 1 | Kování | 132971 |
| 2 | Počáteční profil | 132973 |
| 3 | Profil | 132986 |
| 4 | Žebříkový profil | 132985 |
| 5 | Koncový profil | 133469 |
| 6 | Průlez (hliník) | 132984 |
| 7 | Nýt | 722318 |
| 8 | Guma EPDM 65 | 132587 |
| 9 | Západka pro EAW - 2 | 132598 |
| 10 | Profil západky | 132588 |
| 11 | Pant | 132586 |
| 12 | Pant Druhá část | 132606 |

| Platné pro: | Číslo výrobku |
|---------------------------------|---------------|
| Podlaha s průřezem UAA 75x150-L | 132993 |
| Podlaha s průřezem UAA 75x200-L | 132990 |
| Podlaha s průřezem UAA 75x250-L | 133314 |
| Podlaha s průřezem UAA 75x300-L | 133315 |

PERI Nájemní kritéria

Fasádní lešení PERI UP



| Podlaha s průřezem UAA UAW | Popis | Instrukce | Fakturace | Typ |
|------------------------------|-------|-----------|-----------|-----|
|------------------------------|-------|-----------|-----------|-----|

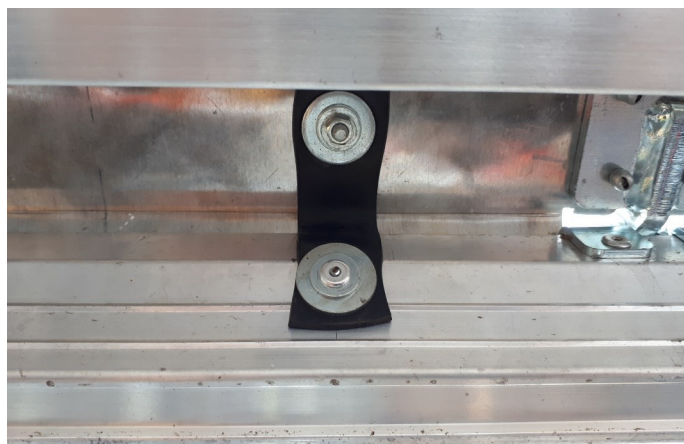

Guma EPDM 65

- Opotřebovaná
- Nařízlá/ uříznutá



Háčky na kování

- Bez prasklin v háčcích a ohnutí ≤ 5 mm
- Ohnutí > 5 mm
- Praskliny v háčcích



PERI Nájemní kritéria

Fasádní lešení PERI UP



| Podlaha s průlezem UAA UAW | Popis | Instrukce | Fakturace | Typ |
|------------------------------|-------|-----------|-----------|-----|
|------------------------------|-------|-----------|-----------|-----|



Nefunkční západka



Průlez

- Opotřebovaný



- Poškozen silou



PERI Nájemní kritéria

Fasádní lešení PERI UP











| Podlaha s průřezem UAA UAW | Popis | Instrukce | Fakturace | Typ |
|--|---|-----------|-----------|-----|
| | Žebřík | | | |
| | <ul style="list-style-type: none"> ■ Chybí | | | |
| <ul style="list-style-type: none"> ■ Praskliny ve svárech | | | | |
| | Pant Pant Druhá Část | | | |
| | <ul style="list-style-type: none"> ■ Chybí | | | |
| <ul style="list-style-type: none"> ■ Poškozen silou (nefunkční) | | | | |

PERI Nájemní kritéria

Fasádní lešení PERI UP



| Podlaha s průlezem UAA | Popis | Instrukce | Fakturace | Typ | |
|--|---|--|---|--|---|
|  | Hliníkový profil |  |  |  | |
| | <ul style="list-style-type: none"> ■ Praskliny v profilu | | | |  |
| <ul style="list-style-type: none"> ■ Díry > Ø 5 mm | Základní blok |  | 133014 (Základní blok) |  | |
|  | | | | | |

PERI Nájemní kritéria

Fasádní lešení PERI UP



| Podlaha s průřezem UAW | Popis | Instrukce | Fakturace | Typ |
|------------------------|-----------------|-----------|-----------|-----|
| | Dřevěná podlaha | | | |
| | ■ Opotřebovaná | | | |

PERI Nájemní kritéria

Fasádní lešení PERI UP



| Spojka UH 30/60 (137211) | Popis | Instrukce | Fakturace | Typ |
|--------------------------|-------|-----------|-----------|-----|
|--------------------------|-------|-----------|-----------|-----|

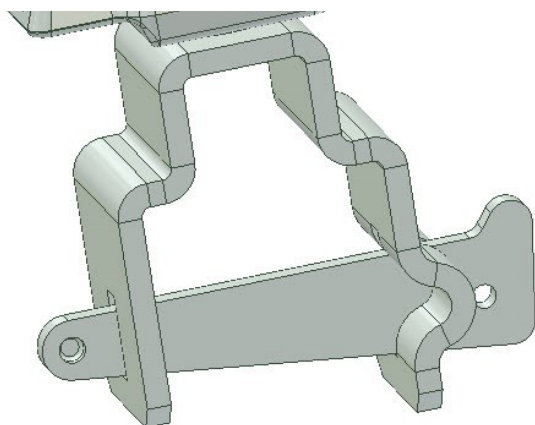

Ohnutý držák

- Lze narovnat
- Nelze narovnat

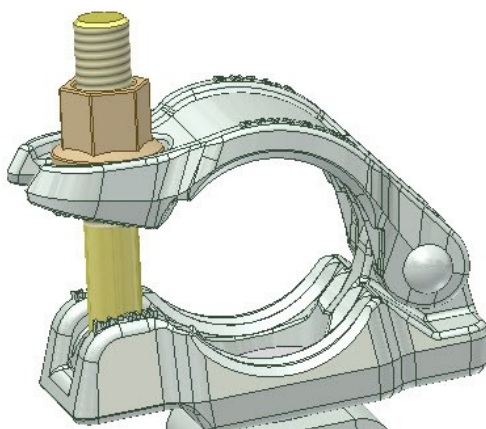

Šroub s klad. hlavou | Matice

- Chybí
- Poškozeno silou (nefunkční)



PERI Nájemní kritéria

Fasádní lešení PERI UP



| Lešenářské spojky | Číslo | Popis | Číslo výrobku |
|-------------------|-------|-------|---------------|
|-------------------|-------|-------|---------------|



2

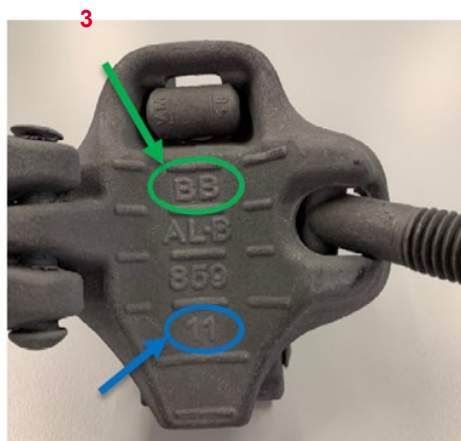

4

- | | |
|---|--|
| 1 | Odkaz na normu EN 74 |
| 2 | Jméno a značka výrobce (nemusí být PERI) |
| 3 | Označení kvality |
| 4 | Rok výroby |















Platné pro:

| | |
|-----------------------------------|--------|
| KLOUBOVÁ SPOJKA DK 38/48, POZ. | 102400 |
| KLOUB. SPOJKA 1 DK 48/48 POZ. | 017010 |
| KLOUBOVÁ SPOJKA DK 60/48 POZ. | 017000 |
| KLOUBOVÁ SPOJKA DK 33 ,7/38, POZ. | 017070 |
| PEVNÁ SPOJKA NK 1 48/48 POZ. | 017020 |
| PEVNÁ SPOJKA NK 2 60/48, POZ. | 017030 |
| ÚCHYTKA PRO TRUBKU 48MM, POZ. | 017040 |

PERI Nájemní kritéria

Fasádní lešení PERI UP













| Lešenářské spojky | Popis | Instrukce | Fakturace | Typ |
|-------------------|---|---|---|---|
| | Značení <ul style="list-style-type: none"> ■ Plně označeno ■ Chybí značení | <ul style="list-style-type: none">   Možno vydat zpět zákazníkovi | <ul style="list-style-type: none">   | <ul style="list-style-type: none">   |
| | Šroub Matice <ul style="list-style-type: none"> ■ Chybí ■ Poškozeno silou ■ Nefunkční z důvodu opotřebení (rez) | <ul style="list-style-type: none">    | <ul style="list-style-type: none">    | <ul style="list-style-type: none">    |

PERI Nájemní kritéria

Fasádní lešení PERI UP











| Lešenářské spojky | Popis | Instrukce | Fakturace | Typ |
|--|---------------------------|---|--|--|
|  | Poškozená polovina spojky |   |  |  |
|  | Otočný kloub je poškozen |   |  |  |

PERI Nájemní kritéria

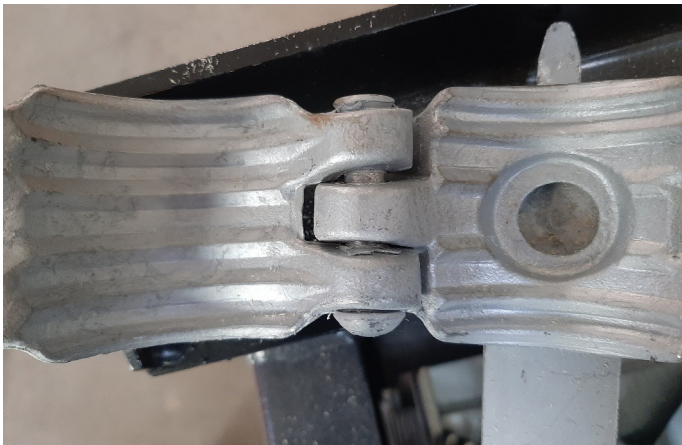
Fasádní lešení PERI UP













| Lešenářské spojky | Popis | Instrukce | Fakturace | Typ |
|--|--|---|--|--|
|  | <p>Vada vnitřního vroubkování</p> <p>Pro spoje bez vrobkouvání od výrobce toto kritérium neplatí</p> |   |  |  |
|  | <p>Poškozený nýt</p> |   |  |  |

PERI Nájemní kritéria

Fasádní lešení PERI UP



| Lešenářské trubky | Popis | Instrukce | Fakturace | Typ |
|--|--|--|--|--|
|  | Ohnutí | | | |
| | <ul style="list-style-type: none"> ■ < L/200 ■ > L/200 |   |   |   |
|  | Zkráceno na stavbě zákazníkem |  |  |  |

PERI Nájemní kritéria

Fasádní lešení PERI UP



| Lešenářské trubky | Popis | Instrukce | Fakturace | Typ |
|---|---|---|---|---|
|  | Díry v trubkách | | | |
| | <ul style="list-style-type: none"> ■ Lze zkrátit |  |  |  |
| | <ul style="list-style-type: none"> ■ Nelze zkrátit |   |  |  |

PERI Nájemní kritéria

Fasádní lešení PERI UP



| Spojnice podlah UDT (136794 136786 136790) | Popis | Instrukce | Fakturace | Typ |
|--|-------|-----------|-----------|-----|
|--|-------|-----------|-----------|-----|

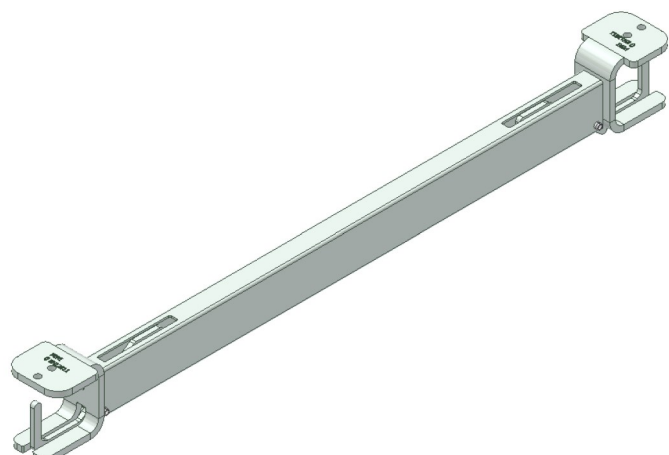

Ohnutí

- Lze narovnat
- Nelze narovnat

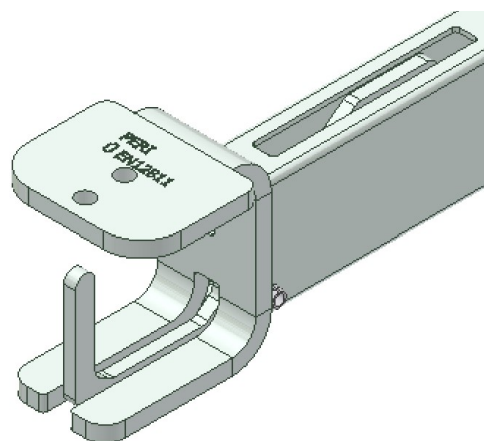

Bezpečnostní západka

- Chybí
- Poškozena silou



PERI Nájemní kritéria

Glossar Icons



| Icon | Význam | Icon | Význam | Icon | Význam |
|---|--|--|----------------------------|---|--|
|  | Není v pořádku - materiál je poškozený |  | Fakturuje se zákazníkovi |  | Optické poškození |
|  | Ok - material zůstává v nájemním skladu |  | Nefakturuje se zákazníkovi |  | Funkční poškození |
|  | Poškozený material - není dovoleno material vydávat z bezpečnostních důvodů |  | Zkrácení prvku |  | Funkční poškození - není dovoleno vydávat material z bezpečnostních důvodů |
|  | Oprava dle instrukcí |  | Označení prvku barvou |  | Statické poškození - není dovoleno vydávat material z bezpečnostních důvodů |
|  | Oprava za studena - poté kontrola svárů a sousedních dílů |  | Výměna poškozeného dílu | | |
|  | Oprava po výpočtu hospodárnosti |  | Doplnění chybějícího dílu | | |
|  | Očištění materiálu | | | | |