

# PERI Nájemní kritéria

## LGS Zastřešení

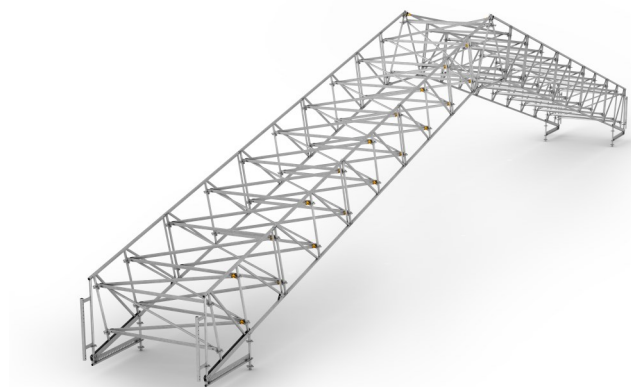

### Kontakt

**PERI, spol. s r.o.**  
**bednění lešení služby**

Průmyslová 392  
252 42 Jesenice u Prahy  
tel.: 222 359 311  
info@peri.cz  
www.peri.cz

Obsah	Strana
LGS prvky	2
Kolejnice al. URT	8
Podp. kolečko UEW	15
Kolejnice URK	16
Kederová spojka URK   URV	18
Naviják na plachtu URG	20
Konektor navijáku URG	21
Spojovací nástavec URP	22
Vysvětlivky	23

Poslední změny	Datum  Iniciály	Strana
Nová verze	06/2017   fw	
LGS 75 Přidány výrobky	11/2019   fw	2;24

# PERI Nájemní kritéria

## LGS Zastřešení



LGS Prvky	Č.	Popis	Číslo výrobku
-----------	----	-------	---------------

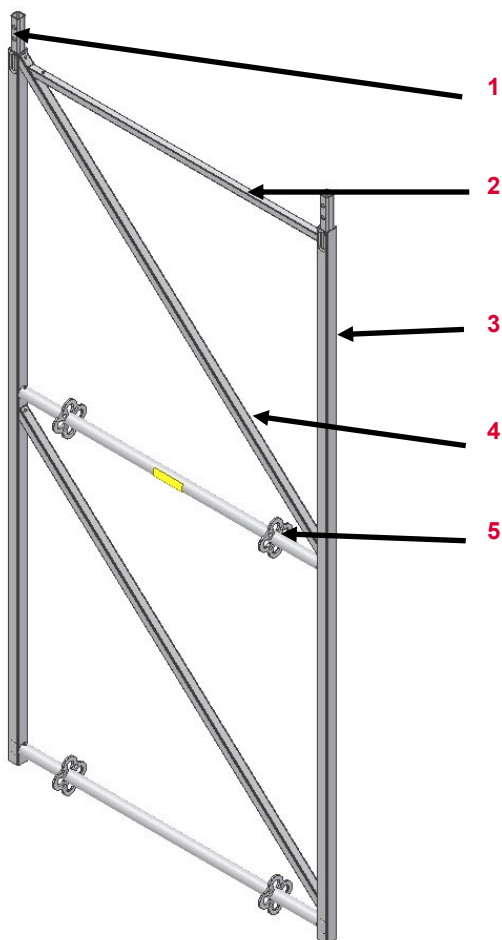

1	Trn
2	Svislý sloupek
3	Pásnice
4	Diagonála
5	Rozeta



### Platné pro:

Vazný díl LGS URB 300/150	104768
Náběhový díl LGS URB 300/150	126483
Vazný díl LGS URB 150/150	104792
Střední díl LGS URB 150/150	116122
Vrcholový díl LGS URR 150	104769
Koncovka URB 150	105334
Vazný díl LGS URB 300/75	135766
Náběhový díl LGS URB 300/75	135793
Vazný díl LGS URB 150/75	135773
Vrcholový díl LGS URR 75	135782
Střední díl LGS URB 75	135777

# PERI Nájemní kritéria

## LGS Zastřešení

















LGS Prvky	Popis	Instrukce	Fakturace	Typ
	<b>33.50.01 Ohnutý trn</b>			
	<ul style="list-style-type: none"> <li>Osazení je možné a nejsou praskliny v materiálu</li> </ul>			
	<ul style="list-style-type: none"> <li>Není možné osazení</li> </ul>			
	<ul style="list-style-type: none"> <li>praskliny v materiálu</li> </ul>			
	<b>33.50.02 Ohnutá rozeta</b>			
	<ul style="list-style-type: none"> <li>≤ 20 mm</li> </ul>			
	<ul style="list-style-type: none"> <li>&gt; 20 mm</li> </ul>			
	<ul style="list-style-type: none"> <li>Prasklina v rozetě</li> </ul>			

# PERI Nájemní kritéria

## LGS Zastřešení



























LGS spoj URC (115978)	Popis	Instrukce	Fakturace	Typ
	<b>33.50.03 Nýt/ Závlačka</b>	 106031 (Nýt) 018060 (Závlačka)		
	<ul style="list-style-type: none"> <li>■ Chybějící</li>   <li>■ Poškození hrubou silou</li> </ul>	 106031 (Nýt) 018060 (Závlačka)		
	<b>33.50.04 Trubka ohnutá/ promáčknutá</b>			
	<ul style="list-style-type: none"> <li>■ Spojení je možné</li> </ul>			
	<ul style="list-style-type: none"> <li>■ Prasklina v materiálu</li> </ul>			

# PERI Nájemní kritéria

## LGS Zastřešení











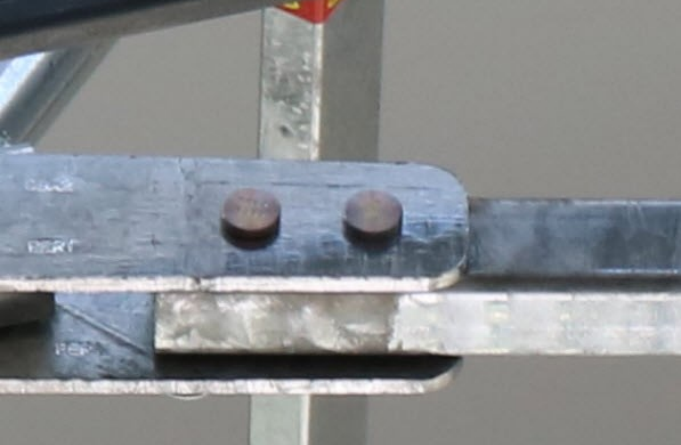





Podp. závora URS (105399; 104771; 104770)	Popis	Instrukce	Fakturace	Typ
	<b>33.50.05 Ohnutý nosník</b>			
	■ Osazení je možné			
	■ Osazení není možné	 		
	■ Prasklina v materiálu	 		
	<b>33.50.06 Ohnutá rozeta</b>			
	■ ≤ 20 mm			
	■ > 20 mm	 		
	■ Prasklina v materiálu	 		

# PERI Nájemní kritéria

## LGS Zastřešení



Vrcholová rozpěra UR (128334; 104778)	Popis	Instrukce	Fakturace	Typ
	<b>33.50.07 Nýt   Závlačka   Šouby   Matice</b>			
	<ul style="list-style-type: none"> <li>■ Chybějící</li> </ul>			
	<ul style="list-style-type: none"> <li>■ Poškození hrubou silou</li> </ul>			
	<b>33.50.08 Ohnutý nosič</b>			
	<ul style="list-style-type: none"> <li>■ Je možné osadit</li> </ul>			
	<ul style="list-style-type: none"> <li>■ Osazení není možné</li> </ul>			

# PERI Nájemní kritéria

## LGS Zastřešení



Pojezd URW (104777)	Popis	Instrukce	Fakturace	Typ
	<b>33.50.09 Ohnutá rolna</b> <ul style="list-style-type: none"> <li>■ Funkční a funkce ochrany proti zvedání není omezena</li> <li>■ Nefunkční</li> </ul>	<ul style="list-style-type: none"> <li>✓</li> <li>⚙️ 104776 (pojezd)</li> </ul>	<ul style="list-style-type: none"> <li>🚫</li> <li>📄</li> </ul>	<ul style="list-style-type: none"> <li>👁️</li> <li>⚙️</li> </ul>
	<b>33.50.10 Nýt   Závlačka</b> <ul style="list-style-type: none"> <li>■ Chybějící</li> <li>■ Poškození hrubou silou</li> </ul>	<ul style="list-style-type: none"> <li>🔧</li> <li>⚙️</li> </ul>	<ul style="list-style-type: none"> <li>📄</li> <li>📄</li> </ul>	<ul style="list-style-type: none"> <li>⚙️</li> <li>⚙️</li> </ul>

# PERI Nájemní kritéria

## LGS Zastřešení



Kolejnice al. URT	Č.	Popis	Číslo výrobku
-------------------	----	-------	---------------

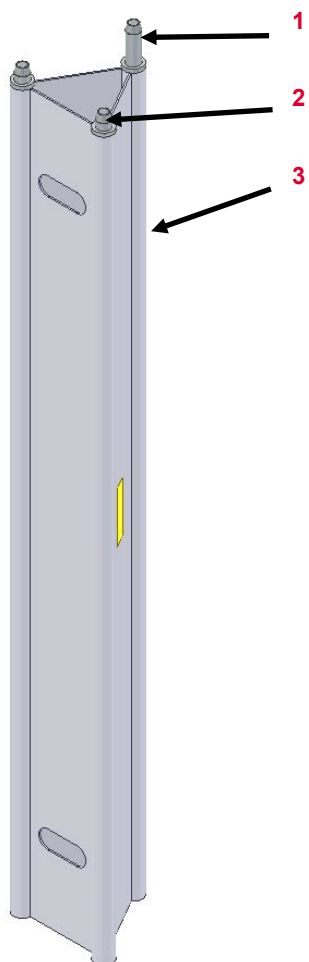











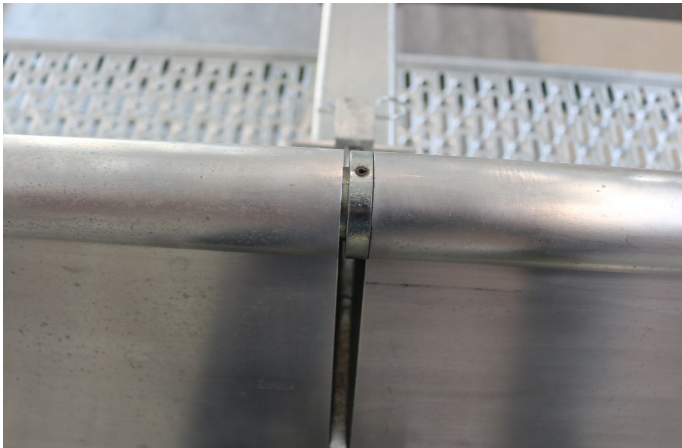



1	Dlouhý trn	104800
2	Krátký trn	104848
3	Kolejnice	













Platné pro:	
Kolejnice al. URT 150	104790
Kolejnice al. URT 200	104791
Kolejnice al. URT 250	104796
Kolejnice al. URT 300	104797





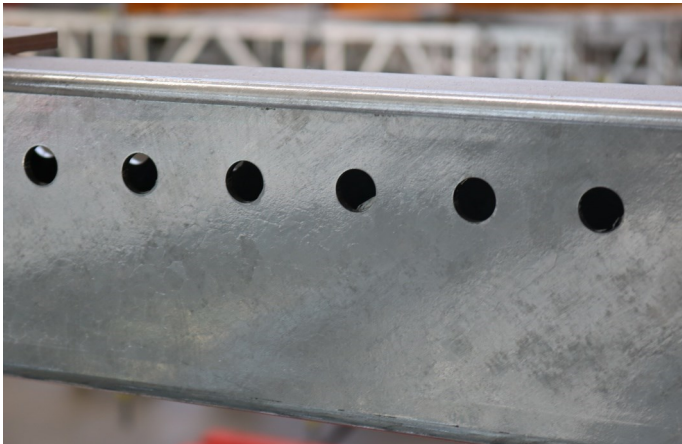









# PERI Nájemní kritéria LGS Zastřešení

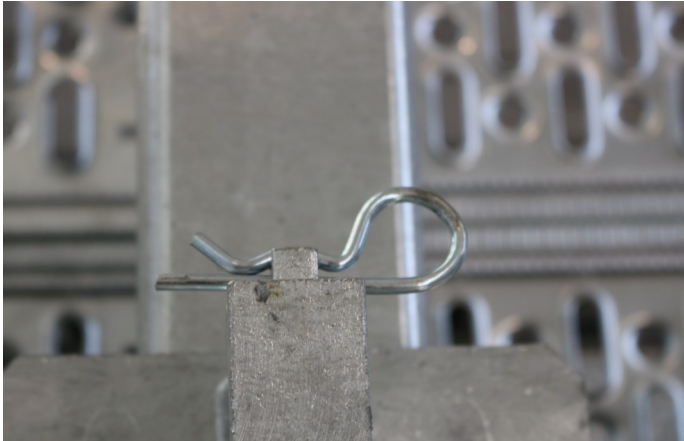

Kolejnice al.	Popis	Instrukce	Fakturace	Typ
	<b>33.50.11 Spoj</b>			
	<ul style="list-style-type: none"> <li>■ Chybějící</li> </ul>			
	<ul style="list-style-type: none"> <li>■ Poškození hrubou silou</li> </ul>			
	<b>33.50.12 Ohnutá kolejnice</b>			
	<ul style="list-style-type: none"> <li>■ Pojezd je možný</li> </ul>			
	<ul style="list-style-type: none"> <li>■ Není možný pojezd</li> </ul>			

Závora pojezdu	Popis	Instrukce	Fakturace	Typ
	<b>33.50.13 Spojení ohnuté/ promáčknuté</b> <ul style="list-style-type: none"> <li>■ Vložení svislého sloupku je možné</li> </ul>			
	<ul style="list-style-type: none"> <li>■ Osazení není možné</li> </ul>	 		
	<b>33.50.14 Zvětšený průměr děr</b> <ul style="list-style-type: none"> <li>■ <math>\varnothing &gt; 18</math> mm</li> </ul>	 		

Uchycení kolejnice URF (104853)	Popis	Instrukce	Fakturace	Typ
	<p><b>33.50.15 Ohnuté spojení</b></p> <ul style="list-style-type: none"> <li>■ Osazení je možné (Kolejnice může být vložena)</li> <li>■ Osazení není možné</li> </ul>	<p>      </p>	<p>     </p>	<p>     </p>
	<p><b>33.50.16 Chybějící závlačka</b></p>	<p>              022230 (Závlačka)         </p>	<p>  </p>	<p>  </p>

# PERI Nájemní kritéria

## LGS Zastřešení



Stopař URA-2 (118022)	Popis	Instrukce	Fakturace	Typ
	<b>33.50.17 Chybějící konzolka</b>			
	<b>33.50.18 Ohnutá část</b>			
	<ul style="list-style-type: none"> <li>■ Je možné osazení</li> </ul>	Po kontrole funkčnosti		
	<ul style="list-style-type: none"> <li>■ Osazení není možné</li> </ul>			

# PERI Nájemní kritéria

## LGS Zastřešení



Koncovka URD (104852)	Popis	Instrukce	Fakturace	Typ
	<b>33.50.19 Ohnutý plech</b>			
	<ul style="list-style-type: none"> <li>■ Je možné osazení</li> </ul>			
	<ul style="list-style-type: none"> <li>■ Osazení není možné</li> </ul>			
<ul style="list-style-type: none"> <li>■ Prasklina ve sváru</li> </ul>				
	<b>33.50.20 Trubka ohnutá   promáčknutá</b>			
	<ul style="list-style-type: none"> <li>■ Je možné osazení (vlození trubky je možné)</li> </ul>			
	<ul style="list-style-type: none"> <li>■ Osazení není možné</li> </ul>			
<ul style="list-style-type: none"> <li>■ Prasklina v materiálu</li> </ul>				

# PERI Nájemní kritéria

## LGS Zastřešení



Podpěra LGS URS (105398)	Popis	Instrukce	Fakturace	Typ
--------------------------	-------	-----------	-----------	-----



### 33.50.21 Nýt / Závlačka

- Chybějící
- Poškození hrubou silou

- |  |                       |  |  |
|--|-----------------------|--|--|
|  | 106191 (Nýt 24)       |  |  |
|  | 106194 (Nýt 16)       |  |  |
|  | 022230 (Závlačka 5/1) |  |  |
|  | 018060 (Závlačka 4/1) |  |  |
|  | 106191 (Nýt 24)       |  |  |
|  | 106194 (Nýt 16)       |  |  |
|  | 022230 (Závlačka 5/1) |  |  |
|  | 018060 (Závlačka 4/1) |  |  |

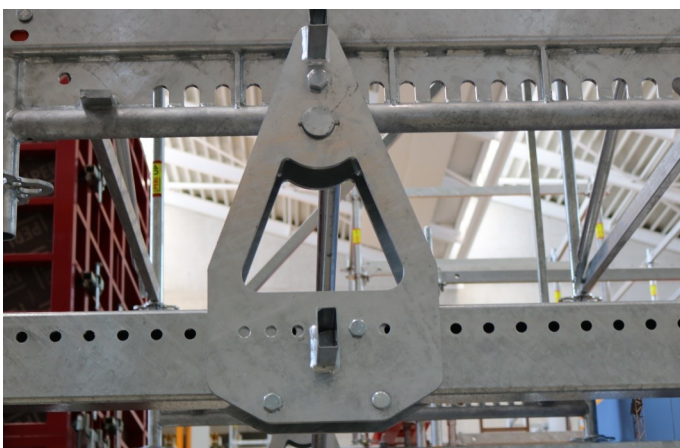

### 33.50.22 Ohnutí / Promáčknutí

- Je možné osazení
- Osazení není možné

- |  |  |  |
|--|--|--|
|  |  |  |
|  |  |  |

# PERI Nájemní kritéria

## LGS Zastřešení



Podp. kolečko UEW (104854)	Popis	Instrukce	Fakturace	Typ
	<b>33.50.23 Ohnutý držák kolečka</b>	<ul style="list-style-type: none"> <li>■ Je možné osazení (pojízdné kolečko)</li> </ul>		
	<ul style="list-style-type: none"> <li>■ Osazení není možné</li> </ul>			
	<b>33.50.24 Kolečko</b>	<ul style="list-style-type: none"> <li>■ Opotřebované</li> </ul>		
	<ul style="list-style-type: none"> <li>■ Poškození hrubou silou</li> </ul>		057164	

# PERI Nájemní kritéria

## LGS Zastřešení



LGS Kolejnice URK	Č.	Popis	Číslo výrobku
-------------------	----	-------	---------------

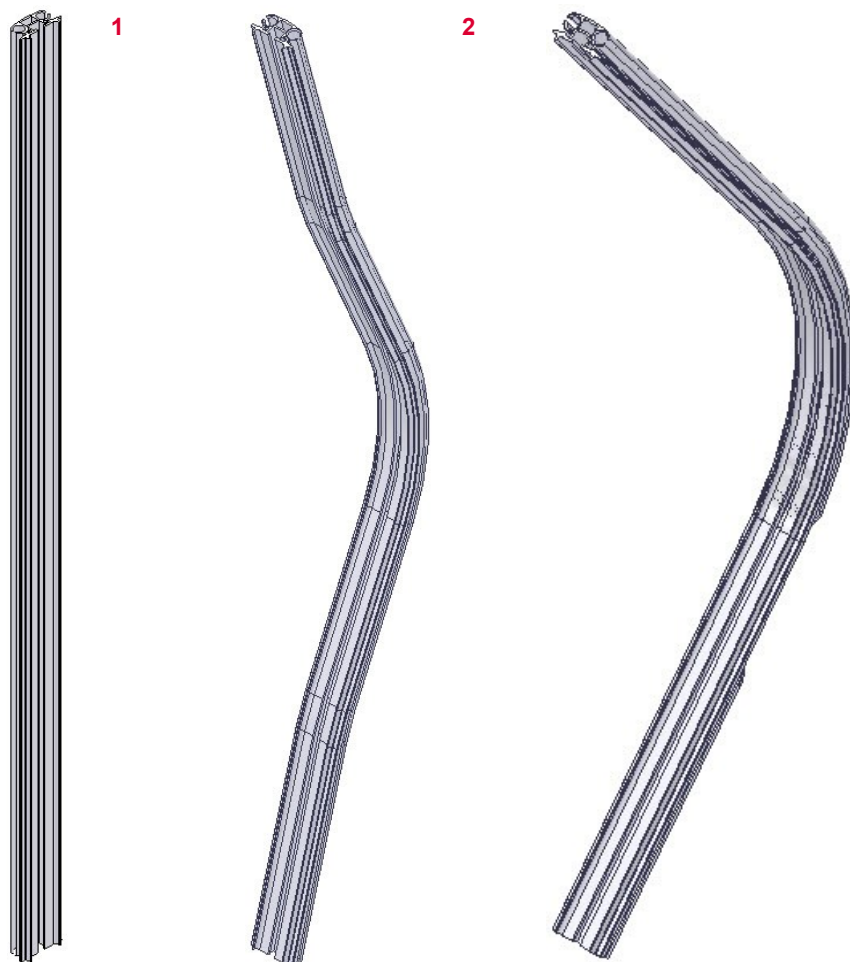

1	Kolejnice
2	Vrcholová kolejnice
3	Náběhová kolejnice















Platné pro:	
LGS Kolejnice URK 150	127501
LGS Kolejnice URK 300	127500
LGS Kolejnice URK 600	126071
LGS Vrchol. kolejnice URK 150	126051
LGS Náběhová kolejnice URK	126491



# PERI Nájemní kritéria

## LGS Zastřešení



LGS Kolejnice URK	Popis	Instrukce	Fakturace	Typ
	<b>33.50.25 Kolejnice úplně ohnutá</b>			
	<ul style="list-style-type: none"> <li>Možné vložení kederové plachty</li> <li>Není možné vložení kederové plachty</li> </ul>	<ul style="list-style-type: none"> <li></li> <li></li> </ul>	<ul style="list-style-type: none"> <li></li> <li></li> </ul>	<ul style="list-style-type: none"> <li></li> <li></li> </ul>
	<b>33.50.26 Kolejnice ohnutá   promáčknutá</b>			
	<ul style="list-style-type: none"> <li>Možné vložení kederové plachty</li> <li>Není možné vložení kederové plachty</li> </ul>	<ul style="list-style-type: none"> <li></li> <li></li> </ul>	<ul style="list-style-type: none"> <li></li> <li></li> </ul>	<ul style="list-style-type: none"> <li></li> <li></li> </ul>

# PERI Nájemní kritéria

## LGS Zastřešení



LGS Kederová spojka URK (125166)	Popis	Instrukce	Fakturace	Typ
----------------------------------	-------	-----------	-----------	-----



### 33.50.27 Ohnutý háček

- Osazení je možné
- Osazení není možné



125165 (Háček s maticí)  
125162 (Háček bez matice)



### 33.50.28 Šroub

- Chybějící
- Poškození hrubou silou



126001 (Nýt)

126001 (Nýt)



# PERI Nájemní kritéria

## LGS Zastřešení



LGS Kederová spojka URV (126009)	Popis	Instrukce	Fakturace	Typ
	33.50.29 Šroub   Matice			
	<ul style="list-style-type: none"> <li>■ Chybějící</li> </ul>	131316 (Šroub) 710330 (Matice)		
	33.50.30 Ohnuté vodítko			
	<ul style="list-style-type: none"> <li>■ Poškození hrubou silou</li> </ul>	131316 (Šroub) 710330 (Matice)		

LGS Naviják na plachtu (126484; 126485)	Popis	Instrukce	Fakturace	Typ
---	-------	-----------	-----------	-----

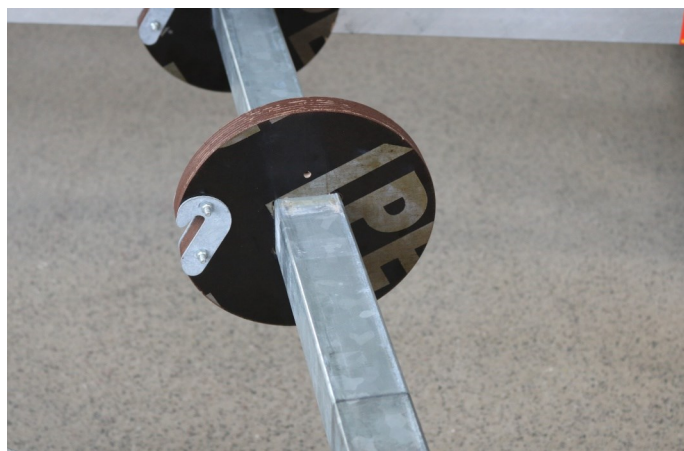

33.50.31 Nepoužitelný kotouč











126949



# PERI Nájemní kritéria

## LGS Zastřešení















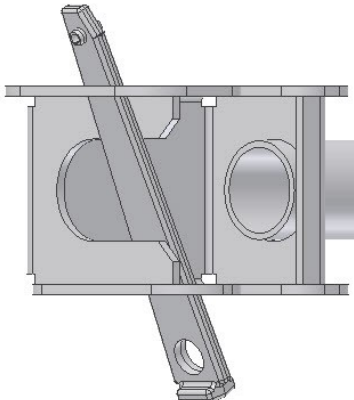

LGS Konektor navijáku URG (126486)	Popis	Instrukce	Fakturace	Typ
	33.50.32 Nýt   Závlačka   Šroub   Matice chybějící	 106031 (Nýt) 018060 (Závlačka) 126924 (Šroub) 710330 (Matice)		
	33.50.33 Klínové spojení			

# PERI Nájemní kritéria

## LGS Zastřešení







LGS Spojovací nástavec URP (105366)	Popis	Instrukce	Fakturace	Typ
	<b>33.50.34 Ohnutá rozeta</b>	<ul style="list-style-type: none"> <li>■ ≤ 20 mm</li> </ul>		
	<ul style="list-style-type: none"> <li>■ &gt; 20 mm</li> </ul>			
	<ul style="list-style-type: none"> <li>■ Prasklina v materiálu</li> </ul>			
	<b>33.50.35 Klínek</b>	<ul style="list-style-type: none"> <li>■ Chybějící</li> </ul>		
	<ul style="list-style-type: none"> <li>■ Nepoužitelný</li> </ul>	<ul style="list-style-type: none"> <li>  024250 (Klínek)   105365 (Závlačka)                 </li> </ul>		

# PERI Nájemní kritéria

## Vysvětlivky znaků



Znak	Význam	Znak	Význam	Znak	Význam
	Není v pořádku – materiál je poškozený		Fakturuje se zákazníkovi		Optické poškození
	OK – materiál zůstává v nájemním skladu		Nefakturuje se zákazníkovi		Funkční poškození
	Poškozený materiál – <b>není dovoleno</b> vydávat materiál z bezpečnostních důvodů		Zkrácení prvku		Funkční poškození — <b>není dovoleno</b> vydávat materiál z bezpečnostních důvodů
	Oprava dle instrukcí		Označení prvku barvou		Statické poškození — <b>není dovoleno</b> vydávat materiál z bezpečnostních důvodů
	Oprava za studena — poté kontrola svárů a sousedních dílů		Výměna poškozeného dílu		
	Oprava po výpočtu hospodárnosti		Doplnění chybějícího dílu		
	Očištění materiálu				