

PERI nájemní kritéria

Palety a stohovatelné zařízení



Kontakt

PERI, spol. s r.o.
bednění lešení služby

Průmyslova 392
252 42 Jesenice u Prahy
tel.: 222 359 311
info@peri.cz
www.peri.cz

Obsah	Strana	Provedené změny	Datum Iniciály	Strana
Mřížová Paleta Paleta na malé díly	3	Nová verze	10/2016 fw	
Paleta RP- 2	9	Přidány informace o značení CE	04/2022 fw	2
Paleta SD 150 x 225	15			
Paleta ST 100-2	18			
Paleta RP 110 x 125	22			
Paleta SD	24			
Paleta EP 110	26			
Paleta USP 72 104	29			
Vysvětlivky	32			

PERI nájemní kritéria

Palety a stohovatelné zařízení



Palety a stohovací zařízení popsané v těchto kritériích nejsou nosná zařízení podle normy 2006/42/EC. Výsledkem toho nemusí být tyto výrobky povinně označeny CE štítkem.

Označení štítkem CE na paletách a stohovacích zařízeních může předcházet tomuto nařízení.

PERI nájemní kritéria

Palety a stohovatelné zařízení



Mřížová Paleta 80 x 120 | Paleta na malé díly 80 x 120

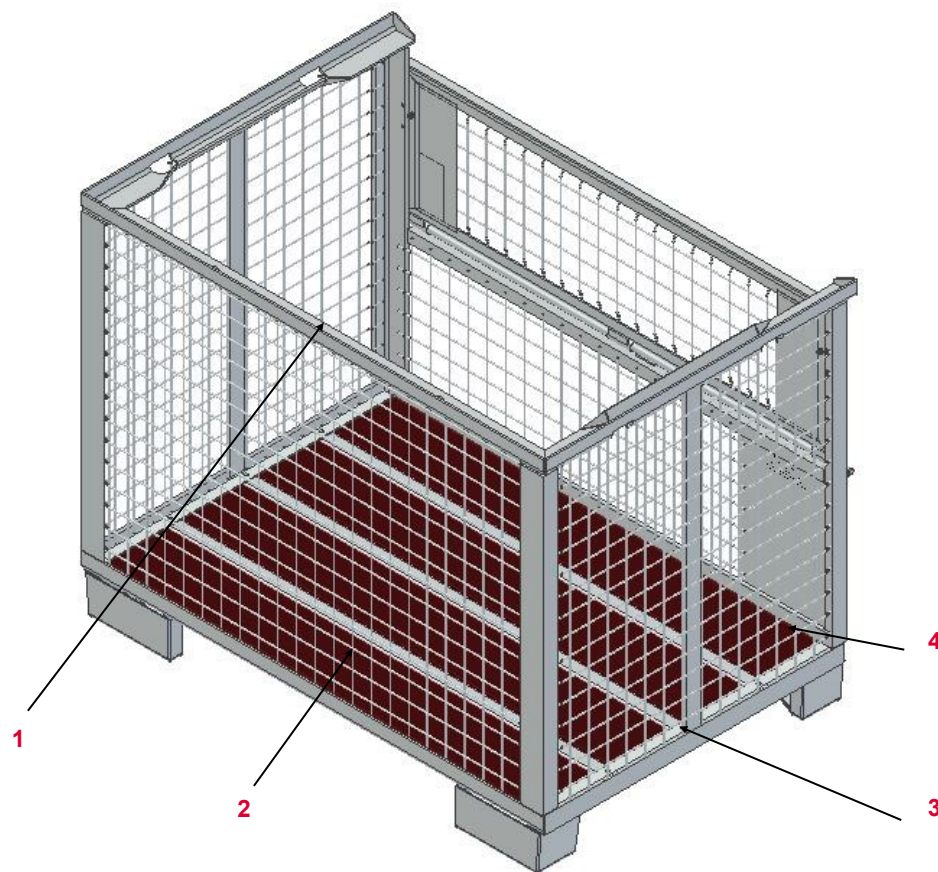

Číslo	Jméno	Číslo výrobku
1	Rám	
2	Podlaha 21 x 156 x 1192	721417
3	Držák podlahy	720689
4	Nýt DIN 7337-A4, 8X12-ST	721412

Platné pro:	Číslo výrobku
Mřížová Paleta 80 x 120, poz.	065068
Mřížová Paleta 80 x120-K, lakovaná	065016
Paleta na malé díly 80 x 120, poz.	025660
Paleta na malé díly 80 x 120, lakovaná	025670

PERI nájemní kritéria

Palety a stohovatelné zařízení



Mřížová Paleta Paleta na malé díly	Popis	Instrukce	Fakturace	Typ
--------------------------------------	-------	-----------	-----------	-----



32.01 Zlomený rám



PERI nájemní kritéria

Palety a stohovatelné zařízení













Mřížová Paleta Paleta na malé díly	Popis	Instrukce	Fakturace	Typ
	32.02 Poškození mříže			
	32.03 Podlaha	721417		
	<ul style="list-style-type: none"> ■ Opatřebovaná 	721417	088995	
	<ul style="list-style-type: none"> ■ Poškozená silou 			

PERI nájemní kritéria

Palety a stohovatelné zařízení











Mřížová Paleta Paleta na malé díly	Popis	Instrukce	Fakturace	Typ
	<p>32.04 Deformace výklopného víka</p> <ul style="list-style-type: none"> ■ Nefunkční 			
	<p>32.05 Deformovaná noha</p> <ul style="list-style-type: none"> ■ Paleta nestojí rovně 			
	<ul style="list-style-type: none"> ■ Nelze bezpečně stohovat 			

PERI nájemní kritéria

Palety a stohovatelné zařízení















Mřížová Paleta Paleta na malé díly	Popis	Instrukce	Fakturace	Typ
	32.06 Deformace jeřabového oka	 		
	32.07 Nečitelný typový štítek	 721400		

PERI nájemní kritéria

Palety a stohovatelné zařízení



Mřížová Paleta Paleta na malé díly	Popis	Instrukce	Fakturace	Typ
	32.08 Zrezivělé			
	■ Ztráta materiálu < 10%			
	■ Ztráta materiálu > 10%	 		
■ Nefunkční	 			

PERI nájemní kritéria

Palety a stohovatelné zařízení



Paleta RP-2 80 x 120 | 80 x 150 (103434 | 103429)

Číslo

Jméno

Číslo výrobku

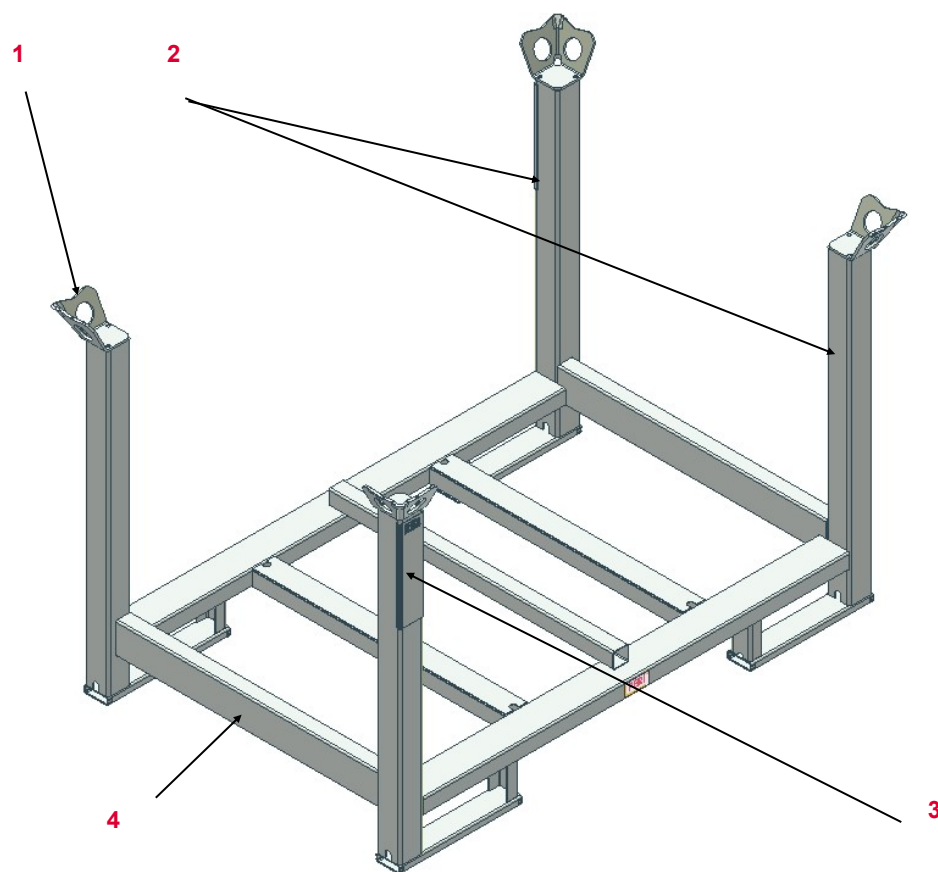

1 Jeřábové oko

2 Noha levá | pravá

3 Typový štítek

4 Rám

PERI nájemní kritéria

Palety a stohovatelné zařízení



Paleta SD 150 x 75 (061500)

Číslo

Jméno

Číslo výrobku

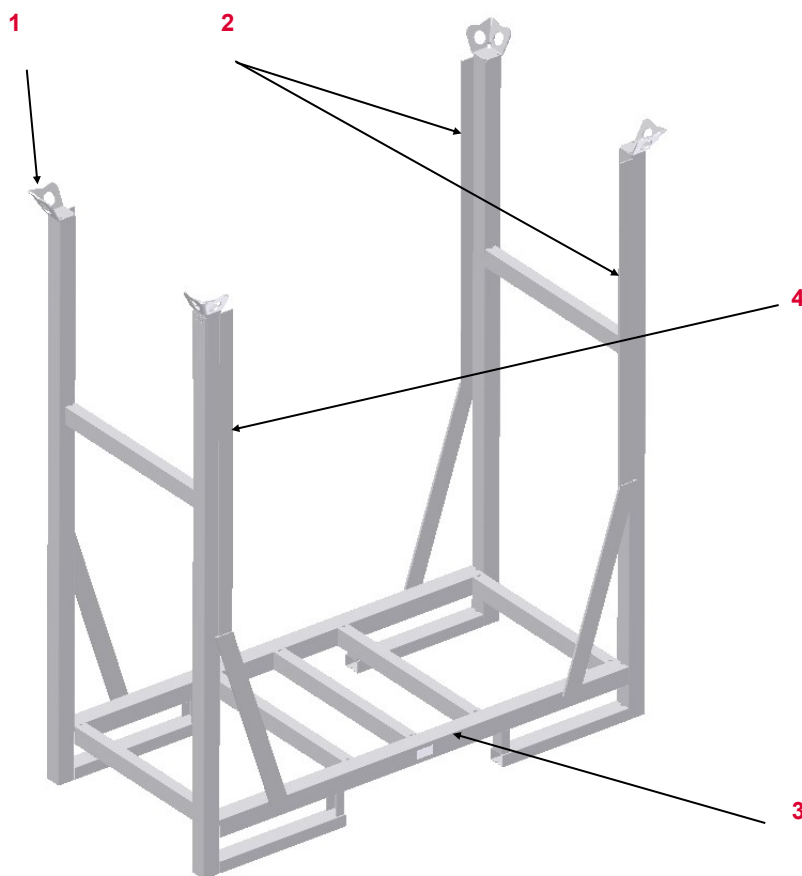

1 Jeřábové oko

2 Noha leva | pravá

3 Rám

4 Bezpečnostní lišta

PERI nájemní kritéria

Palety a stohovatelné zařízení



RP-2 80 x 120/150 SD 150 x 75	Popis	Instrukce	Fakturace	Typ
---------------------------------	-------	-----------	-----------	-----



32.09 Jeřábové oko ohnuté | zlomené



32.10 Noha ohnutá | zlomená



PERI nájemní kritéria

Palety a stohovatelné zařízení











RP-2 80 x 120/150 SD 150 x 75	Popis	Instrukce	Fakturace	Typ
	<p>32.11 Jeřábové oko (verze na fotce do 04/2011) opotřebované</p> <ul style="list-style-type: none"> ■ Obecně: Stará verze oválné Jeřábové oko Nová verze Kruhové jeřábové oko ■ Verze do 04/2011: Zbývající tloušťka materiálu ≤ 16 mm ■ Verze od 04/2011: Zbývající tloušťka materiálu ≤ 15,7 mm 			
	<p>32.12 Ohnutá noha</p> <ul style="list-style-type: none"> ■ Ohnutá noha > 1° 			

PERI nájemní kritéria

Palety a stohovatelné zařízení











RP-2 80 x 120/150 I SD 150 x 75	Popis	Instrukce	Fakturace	Typ
	32.13 Zlom v noze			
	32.14 Ohnutý rám			

PERI nájemní kritéria

Palety a stohovatelné zařízení



RP-2 80 x 120/150 I SD 150 x 75	Popis	Instrukce	Fakturace	Typ
	<p>32.15 Prasklina ve sváru</p> <ul style="list-style-type: none">■ Bez poškození přilehlých částí■ S poškozením přilehlých částí	<p>■ Bez poškození přilehlých částí:  </p> <p>■ S poškozením přilehlých částí:  </p>	<p>■ Bez poškození přilehlých částí: </p> <p>■ S poškozením přilehlých částí: </p>	<p>■ Bez poškození přilehlých částí: </p> <p>■ S poškozením přilehlých částí: </p>

PERI nájemní kritéria

Palety a stohovatelné zařízení



Paleta SD 150 x 225 (061530)

Číslo Jméno Číslo výrobku

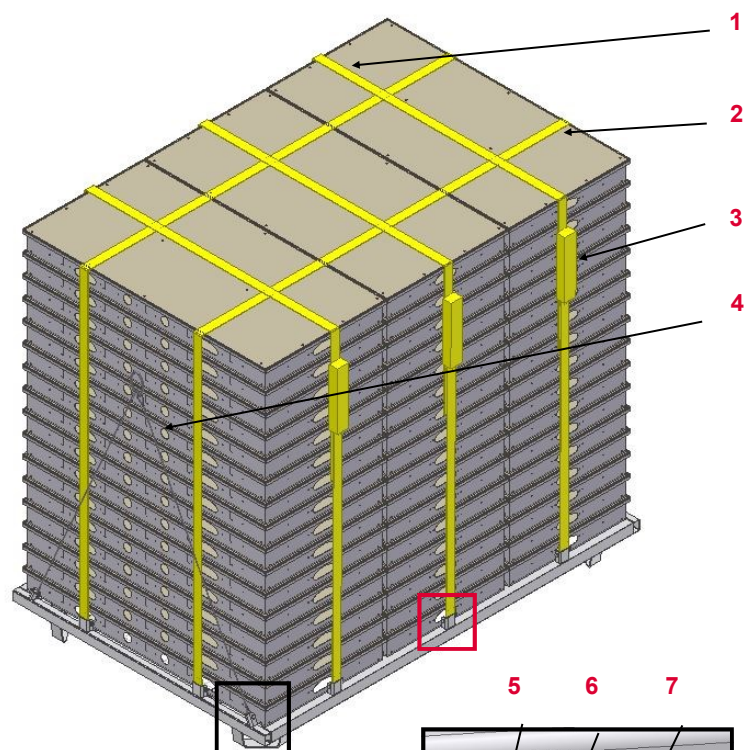

1	Pásek L= 4200 volný konec	710595
2	Pásek L= 5000 volný konec	710596
3	Pásek L= 1400mm	710594
4	Lanový závěs - 2	710597
5	Šroub M 10 x 50	710335
6	Trubka D=16	700372
7	Matice M 10	780356
8	Šroub M 10 x 80	710593
9	Šroub M 10	780356
10	Trubka L = 53	700371

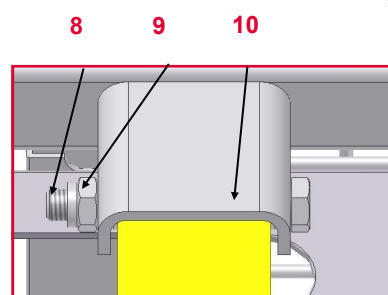
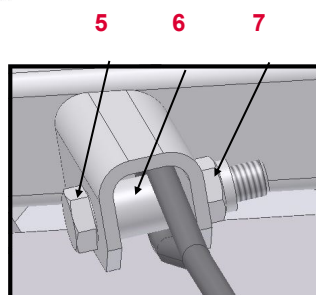

PERI nájemní kritéria

Palety a stohovatelné zařízení



SD 150 x 225	Popis	Instrukce	Fakturace	Typ
	32.16 Pásek Lanový závěs- 2	 <ul style="list-style-type: none"> 710594 (Pásek L= 1400mm) 710595 (Pásek L= 4200) 710596 (Pásek L= 5000) 710597 (Lanový závěs- 2) 		
	<ul style="list-style-type: none"> ■ Poškozený silou 	 <ul style="list-style-type: none"> 710594 (Pásek L= 1400mm) 710595 (Pásek L= 4200) 710596 (Pásek L= 5000) 710597 (Lanový závěs- 2) 		

PERI nájemní kritéria

Palety a stohovatelné zařízení



SD 150 x 225	Popis	Instrukce	Fakturace	Typ
--------------	-------	-----------	-----------	-----

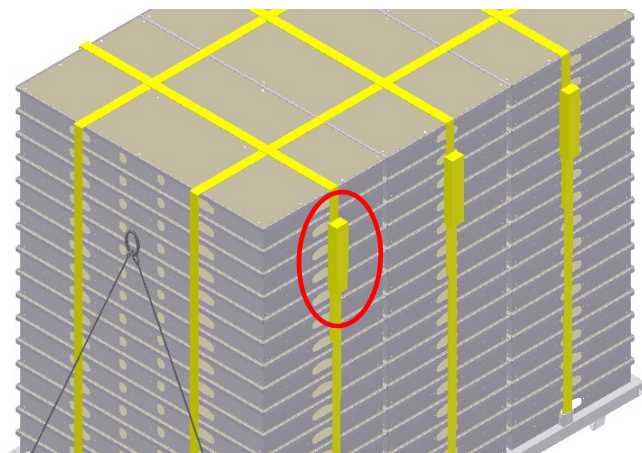

32.17 Stahovací pásek

- Nefunkční ráčna



710594 (Pásek s ráčnou)

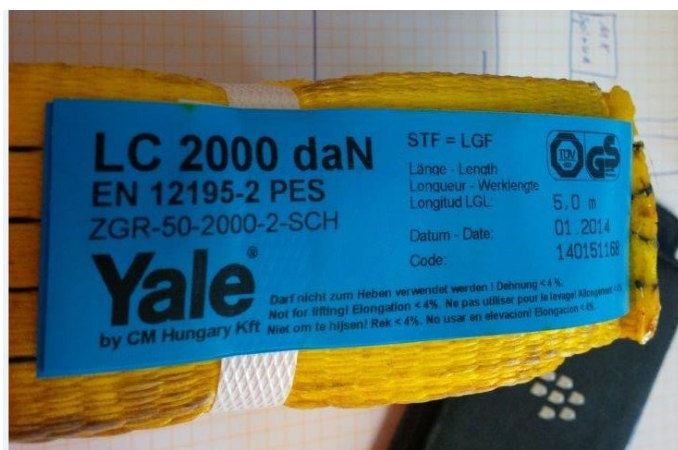

32.18 Chybějící nebo nečitelný typový štítek



710594
710595
710596



PERI nájemní kritéria

Palety a stohovatelné zařízení



Paleta ST 100-2 (065050)

Číslo	Jméno	Číslo výrobku
-------	-------	---------------

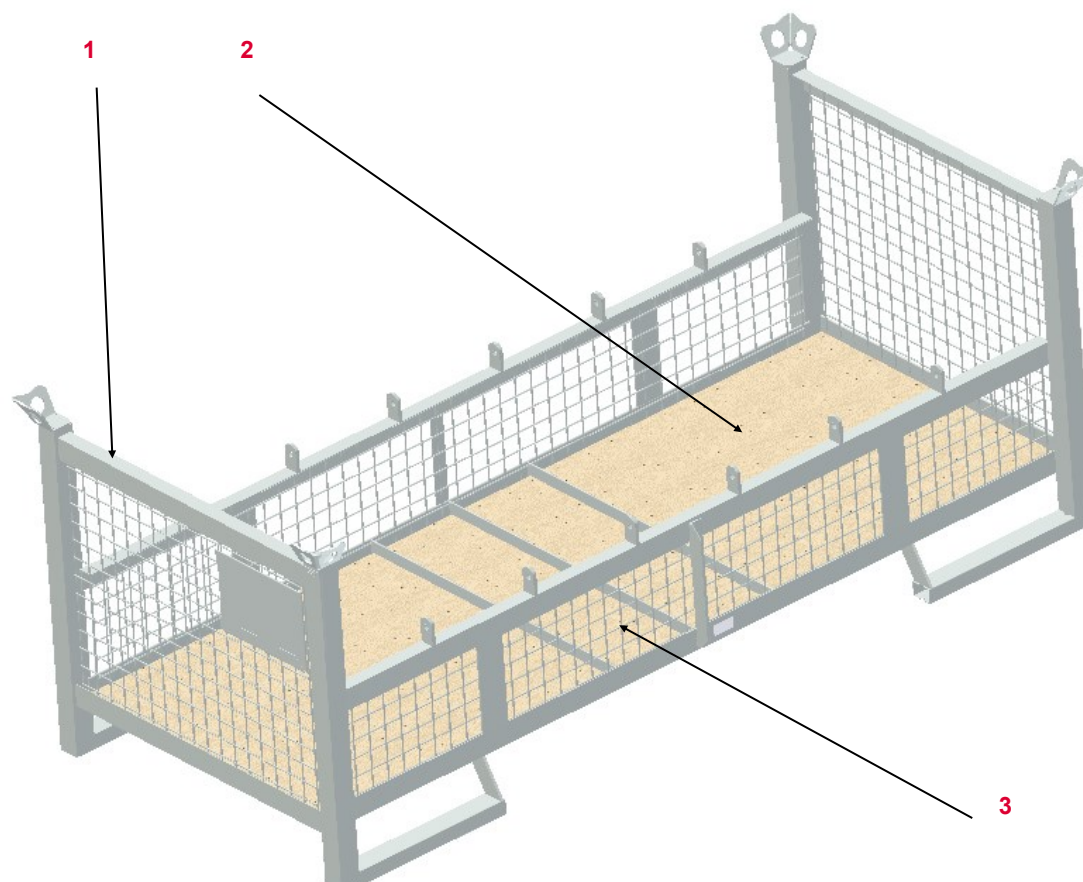











1	Paleta ST 100-2 poz.	106514
2	3-S-Deska 22mm 870x920	102353
3	3-S-Deska 22mm 870x240	102354

PERI nájemní kritéria

Palety a stohovatelné zařízení











Paleta ST 100-2	Popis	Instrukce	Fakturace	Typ
	32.19 Zlomený rám	 		
	32.20 Zlom v noze	 		

PERI nájemní kritéria

Palety a stohovatelné zařízení











Paletová příložka MX (115058)	Popis	Instrukce	Fakturace	Typ
	32.21 Ohnutý profil			
	32.22 Prasklý svár			
	32.23 Chybějící nebo nečitelný typový štítek			
	32.24 Ohnuté	 Kontrola sváru		

PERI nájemní kritéria

Palety a stohovatelné zařízení



Paletová příložka domino (066094)	Popis	Instrukce	Fakturace	Typ
	32.25 Prasklý svár			
	<ul style="list-style-type: none"> ■ Poškození silou (ohnutá příložka) 	 		
	32.26 Nečitelný nebo chybějící typový štítek			
	<ul style="list-style-type: none"> ■ 750059 (Typový štítek) ■ 710217 (Nýt) 			

PERI nájemní kritéria

Palety a stohovatelné zařízení



Paleta RP 110x125	Číslo	Jméno	Číslo výrobku
-------------------	-------	-------	---------------

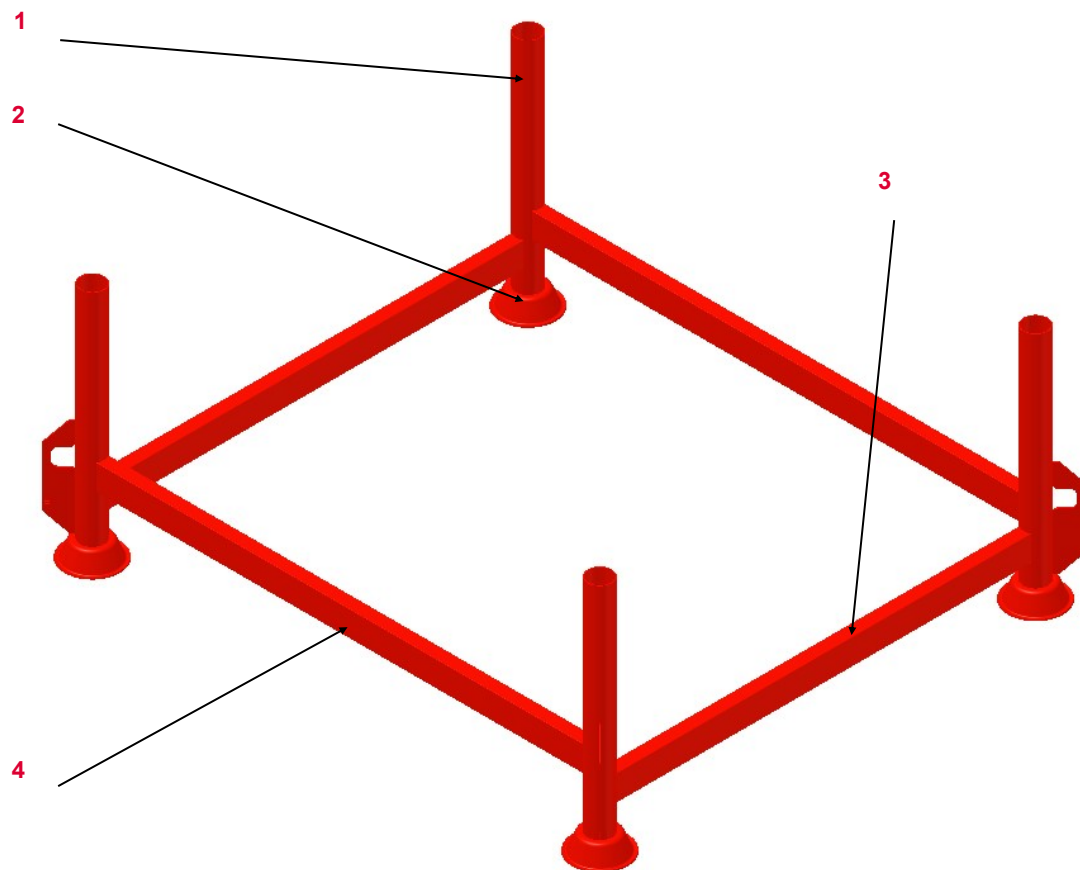

1	Noha
2	Stohovací roh USP
3	Horizontální rám (kratší)
4	Horizontální rám (delší)

Platné pro:	Číslo výrobku
Paleta RP 110x125 lakovaná	106939
Paleta RP 80x110	111396

PERI nájemní kritéria

Palety a stohovatelné zařízení



Paleta RP 110x125 RP 80x110	Popis	Instrukce	Fakturace	Typ
-------------------------------	-------	-----------	-----------	-----

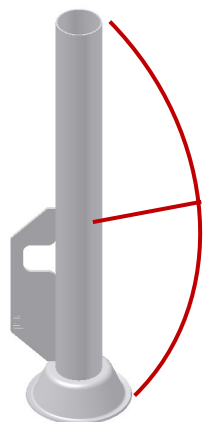

32.27 Noha ohnutá | zlomená

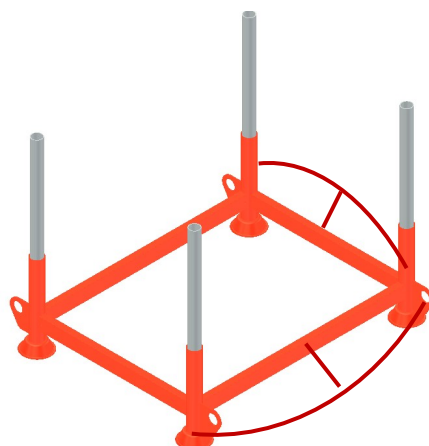

32.28 Ohnutý rám



PERI nájemní kritéria

Palety a stohovatelné zařízení



Paleta SD 75 | 150 (126630 | 126582)

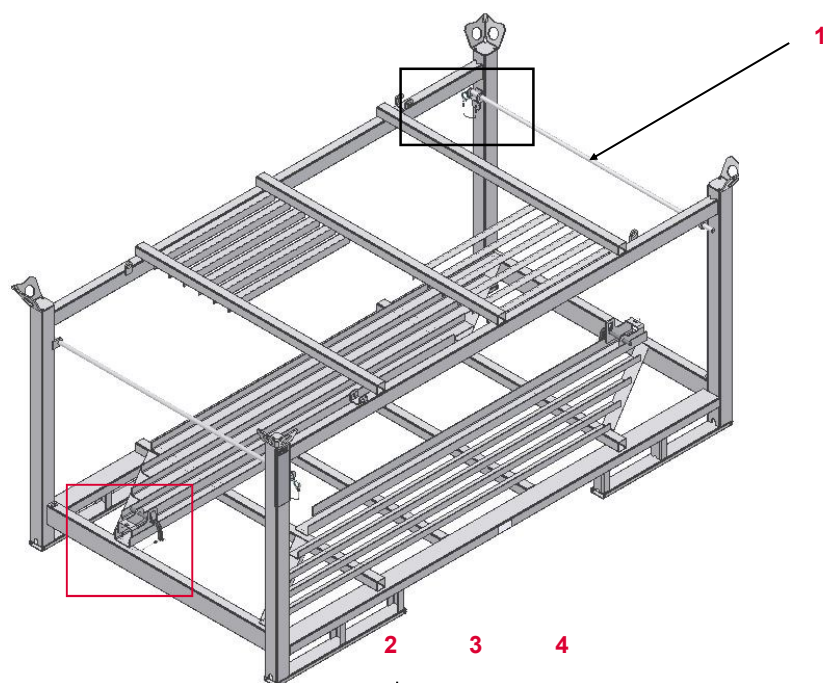

Číslo	Jméno	Číslo výrobku
1	Pojistná trubka	126618
2	Pružinová závlačka	125699
3	Kroužek	127302
4	Ocelové lanko	127303
5	Zamykací závlačka	126638

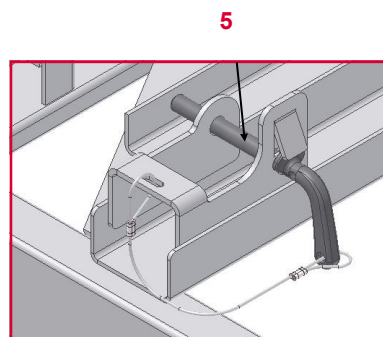
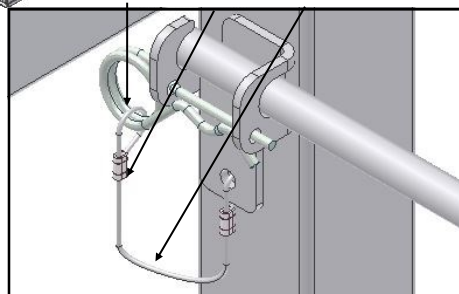

PERI nájemní kritéria

Palety a stohovatelné zařízení



Paleta SD 150 I 75	Popis	Instrukce	Fakturace	Typ
--------------------	-------	-----------	-----------	-----

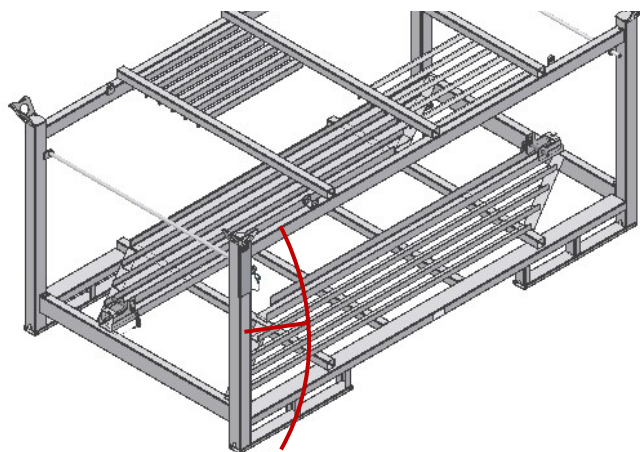

32.29 Zlomená noha

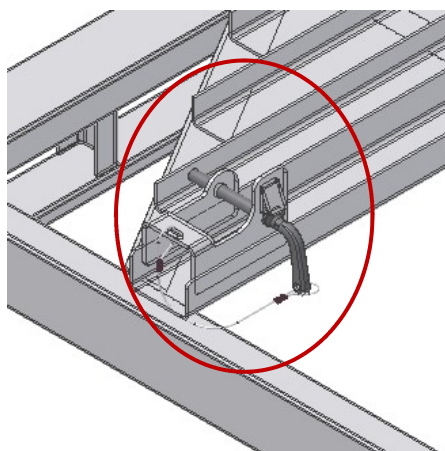

32.30 Chybějící zamykací závlačka



126638



PERI nájemní kritéria

Palety a stohovatelné zařízení



Paleta EP 110 (123960)

Číslo Jméno Číslo výrobku

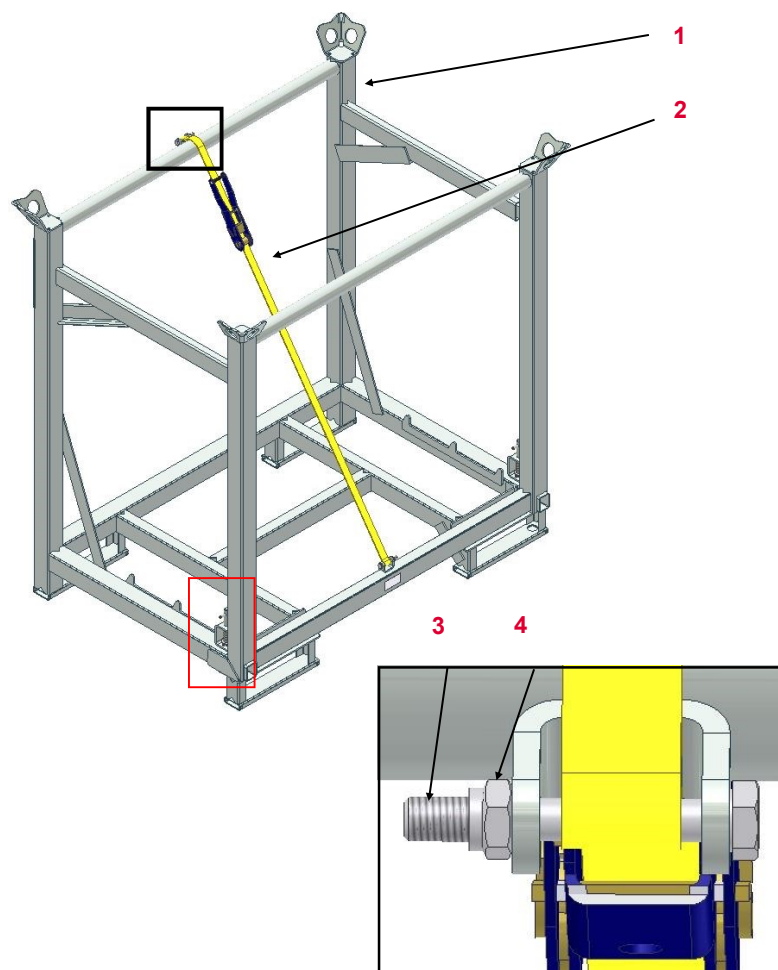









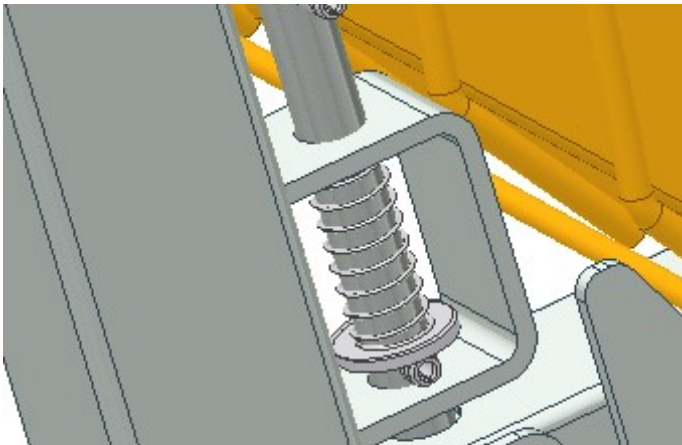

1	Odnímatelná část rámu	123956
2	Vázací popruh 25 x 2550	117560
3	Šroub M 8 x 60	710284
4	Matice M 8	711071
5	Pružina	721816
6	Pružný kolík ISO 8752	725186
7	Závlačka	123947
8	Podložka	711074
9	Napínací vložka 8x27	780807

PERI nájemní kritéria

Palety a stohovatelné zařízení



Paleta EP 110	Popis	Instrukce	Fakturace	Typ
	32.31 Jeřábové oko ohnuté			
	32.32 Závlačka	<ul style="list-style-type: none"> ■ Chybějící 		
	<ul style="list-style-type: none"> ■ Poškozené části 			

PERI nájemní kritéria

Palety a stohovatelné zařízení



Paleta EP 110	Popis	Instrukce	Fakturace	Typ
	32.33 Stahovací páska			
	<ul style="list-style-type: none"> ■ Chybějící 	117560		
	<ul style="list-style-type: none"> ■ Nečitelný typový štítek 	117560		

PERI nájemní kritéria

Palety a stohovatelné zařízení



Paleta USP 72 | 104 (100660 | 100678)

Číslo	Jméno	Číslo výrobku
-------	-------	---------------

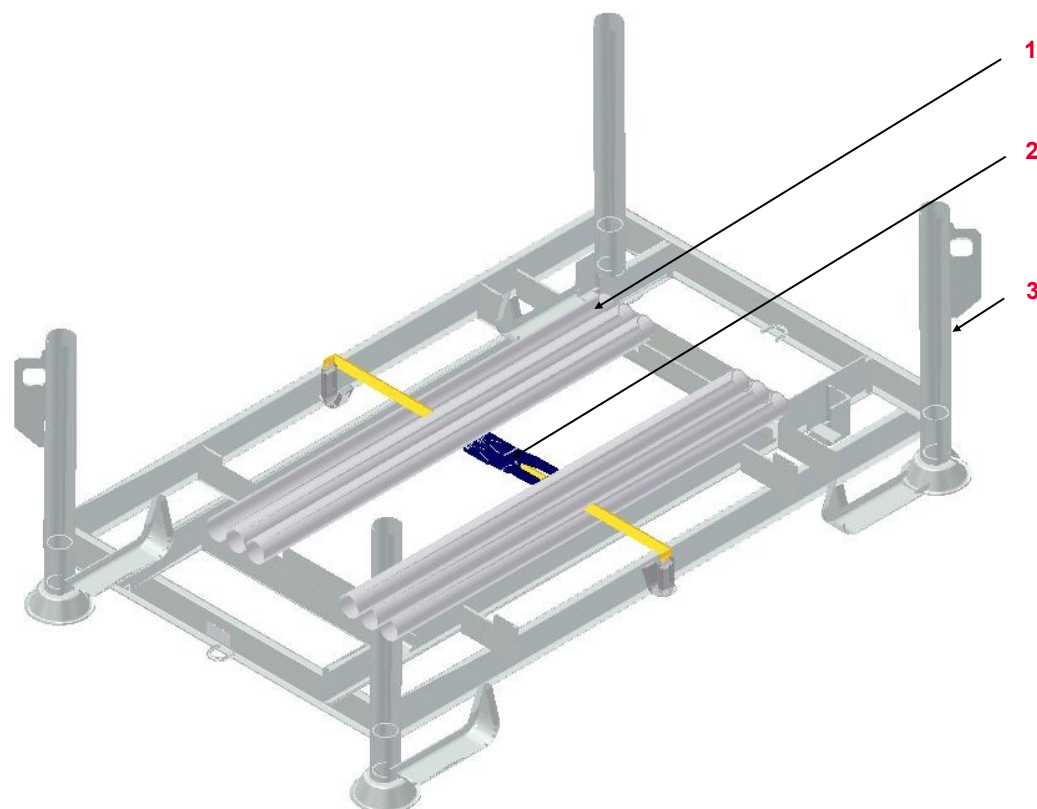









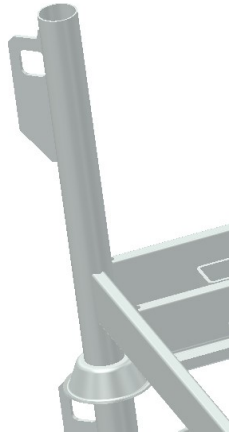



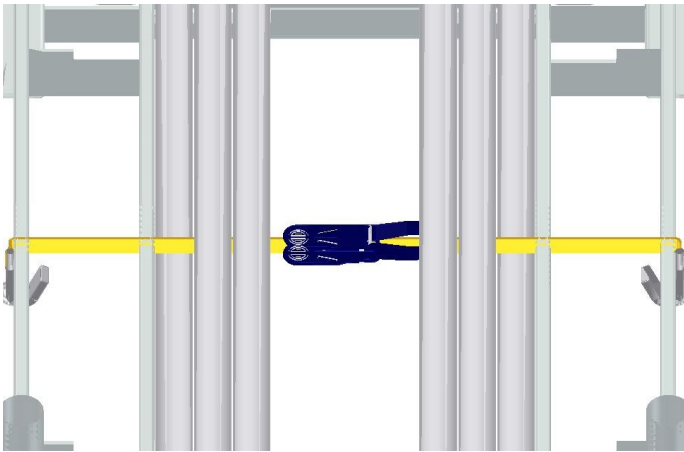

1	Trubky	100706
2	Kurta	100707
3	Nohy	

PERI nájemní kritéria

Palety a stohovatelné zařízení











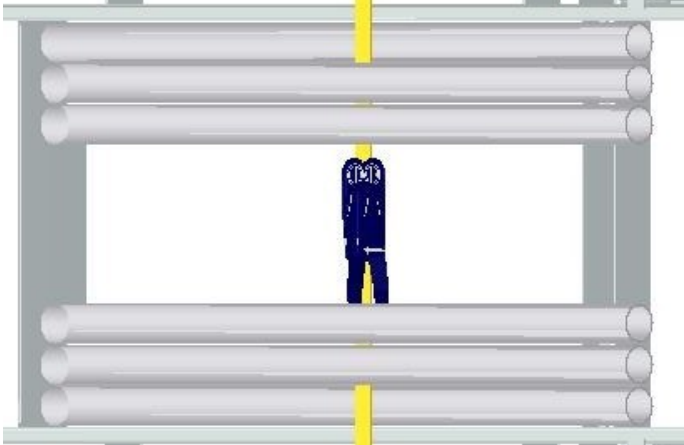











Paleta USP 72 / 104	Popis	Instrukce	Fakturace	Typ
	32.34 Ohnutá noha <ul style="list-style-type: none"> ■ > 1° 	 		
	<hr/>			
	32.35 Kurta <ul style="list-style-type: none"> ■ Poškozená silou (nařizlá kurta atd.) 	 100707		
	<ul style="list-style-type: none"> ■ Chybející 	 100707		
	<ul style="list-style-type: none"> ■ Opotřebovaná 	 100707		

PERI nájemní kritéria

Palety a stohovatelné zařízení



Paleta USP 72 / 104	Popis	Instrukce	Fakturace	Typ
	32.36 Trubky			
	<ul style="list-style-type: none"> ■ Chybějící ■ Poškozená silou 	 100706  100706	 	 
	32.37 Promáčklý Zlomený rám			
	<ul style="list-style-type: none"> ■ ≤ 5 mm hloubky 	 		
	<ul style="list-style-type: none"> ■ Hloubka > 5 mm 	 		
<ul style="list-style-type: none"> ■ Zlom (např. Způsobený VZV) 	 			

PERI nájemní kritéria

Vysvětlivky znaků



Znak	Význam	Znak	Význam	Znak	Význam
	Není v pořádku – materiál je poškozený		Fakturuje se zákazníkovi		Optické poškození
	OK – materiál zůstává v nájemním skladu		Nefakturuje se zákazníkovi		Funkční poškození
	Poškozený materiál – není dovoleno vydávat materiál z bezpečnostních důvodů		Zkrácení prvku		Funkční poškození — není dovoleno vydávat materiál z bezpečnostních důvodů
	Oprava dle instrukcí		Označení prvku barvou		Statické poškození — není dovoleno vydávat materiál z bezpečnostních důvodů
	Oprava za studena — poté kontrola svárů a sousedních dílů		Výměna poškozeného dílu		
	Oprava po výpočtu hospodárnosti		Doplnění chybějícího dílu		
	Očištění materiálu				