

# PERI Nájemní kritéria

## Vysokopevnostní podpěra HD 200

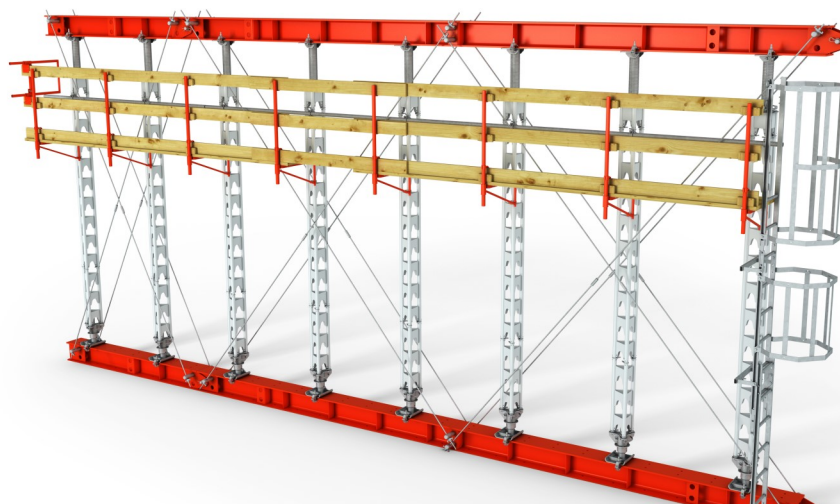

### Kontakt

PERI, spol. s r.o.  
bednění lešení služby  
Prumyslová 392  
252 42 Jesenice u Prahy  
tel.: 222 359 311  
info@peri.cz  
www.peri.cz

Obsah	Str.	Provedené změny	Datum   Autor	Strana
Podpěry HDS   HDSS	2	Nová verze	11/18   fw	
Spouštěcí patka HDA	5			
Hlava HDK 45	8			
Adaptér k patce HD	13			
Nosník HDT	15			
Hlava pro stabilizátor HD	17			
Patka HD	19			
Konzola 75 HD	20			
Úchyt pro stabilizátor HDR	22			

# PERI Nájemní kritéria

## Vysokopevnostní podpěra HD 200



### Podpěry HDS / HDSS

Číslo      Jméno      Číslo výrobku

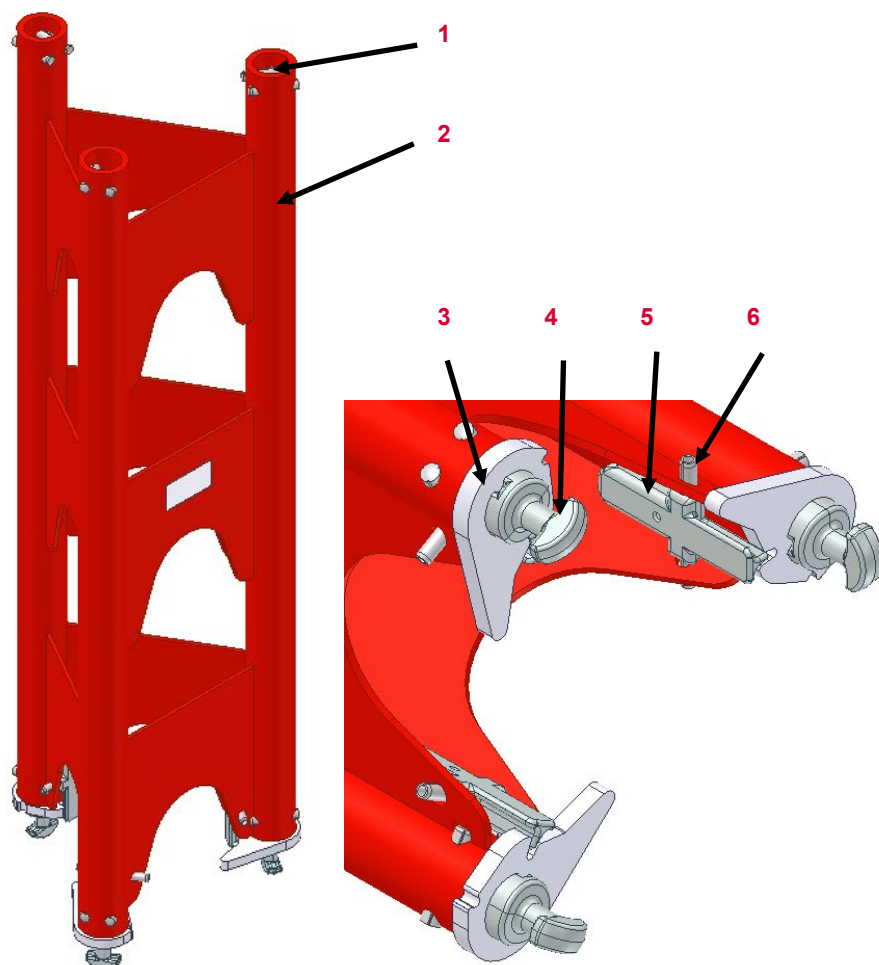

1	Válcový rýhovaný kolík 10x50	780150
2	Podpěra	
3	Deska	780151
4	Spojka pásů HD, pozink	780143
5	Pojistné háky HD, pozink	780144
6	Napínací vložka 8x70	770013

### Platné pro:



### Číslo výrobku

Podpěra HDS 30 Alu	022006
Podpěra HDS 90 Alu	022005
Podpěra HDS 270 Alu	022004
Podpěra HDSS 90 Steel	111276
Podpěra HDSS 210 Steel	103993
Nástavec HD 30	022020

# PERI Nájemní kritéria

## Vysokopevnostní podpěra HD 200



Podpěry	Popis	Instrukce	Fakturace	Typ
	<b>04.10.01 Spojka pásů HD   Poj. Hák</b>			
	■ Chybějící			
	■ Ohnutý			
	■ Prasklý			
	<b>04.10.02 Trubka nebo spoj trubek</b>			
	■ Ohnutý			
	■ Zaříznuté			

# PERI Nájemní kritéria

## Vysokopevnostní podpěra HD 200











Podpěry	Popis	Instrukce	Fakturace	Typ
	04.10.03 Napínací vložka 8x70   Drážka s rýhou			
	<ul style="list-style-type: none"><li>■ Chybí</li></ul>			
	<ul style="list-style-type: none"><li>■ Poškozeno silou</li></ul>			

# PERI Nájemní kritéria

## Vysokopevnostní podpěra HD 200













Spouštěcí patka HDA (022003)	Popis	Instrukce	Fakturace	Typ
	04.10.04 Čep pohonu chybí	 722569 (Čep pohonu) 022018 (Stříhový kolík HDA)		
	04.10.05 Oddělený	 Může být opraveno osobou s potřebnou kvalifikací		

# PERI Nájemní kritéria

## Vysokopevnostní podpěra HD 200



















Spouštěcí patka HDA (022003)	Popis	Instrukce	Fakturace	Typ
	04.10.06 Ohnuté			
	04.10.07 Typový štítek	<ul style="list-style-type: none"> <li>■ Chybí</li> </ul>		
	<ul style="list-style-type: none"> <li>■ Nelze přečíst</li> </ul>			

# PERI Nájemní kritéria

## Vysokopevnostní podpěra HD 200



Spouštěcí patka HDA (022003)	Popis	Instrukce	Fakturace	Typ
	<b>04.10.08 Prasklina ve sváru</b>			
	■ Deformované (promáčklé)	 		
	■ Bez deformací	 		
	<b>04.10.09 Silné znečištění</b>			
	■ Zařízení je po vyčištění funkční			
	■ Po vyčištění není funkční	 		

# PERI Nájemní kritéria

## Vysokopevnostní podpěra HD 200



### Hlava HDK 45 (022007) | Pata stabilizátoru HD (022023)

Číslo      Jméno      Číslo výrobku

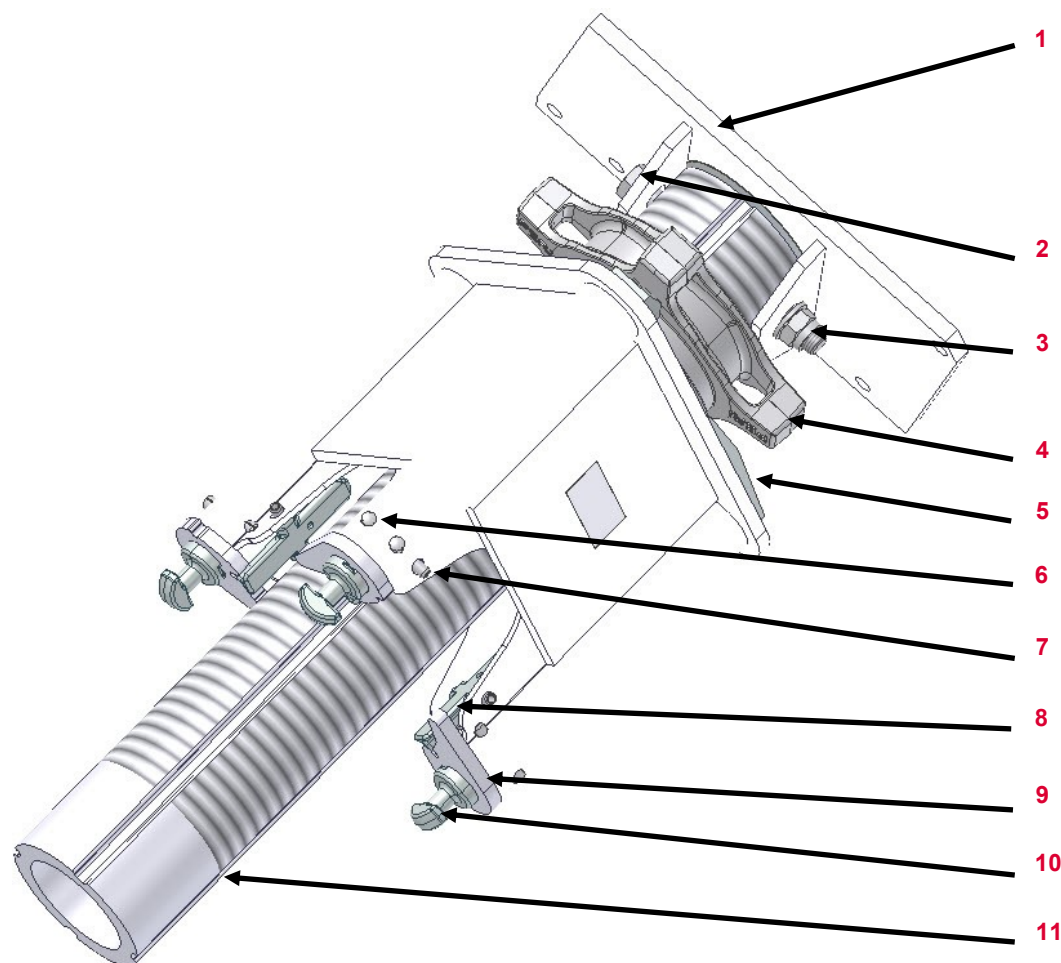

1	Kyvadlová deska se sponami	785263
2	ŠroubM 16 x 160	780155
3	MaticeM 16	070890
4	Stavěcí matice TR	780149
5	Poloviční příchytka	780157
6	Válc. Rýhovaný kolík	780150
7	Napínací vložka 6x20	780800
8	Pojistné háky HD	780144
9	Deska	780151
10	Spojka pásů HD	780143
11	Trubka se závitem TR 110x9	770210



Hlava HDK 45   Pata stabilizátoru HD	Popis	Instrukce	Fakturace	Typ
--------------------------------------	-------	-----------	-----------	-----



04.10.10 Kyvadlová deska se sponami

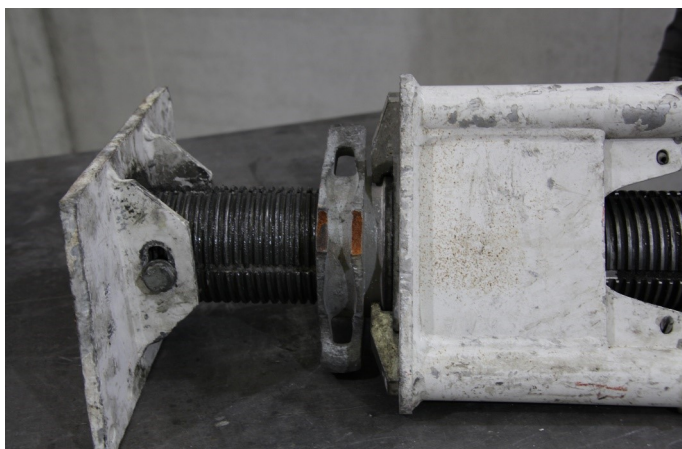









04.10.11 Stavěcí matice TR 110x9



# PERI Nájemní kritéria

## Vysokopevnostní podpěra HD 200

















Hlava HDK 45   Pata stabilizátoru HD	Popis	Instrukce	Fakturace	Typ
	04.10.12 Poloviční přichytka chybí			
	04.10.13 Vřeteno   Poškozené vřeteno, nefunkční			









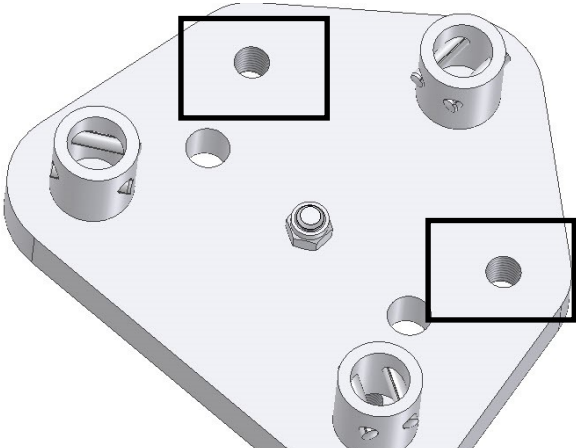

# PERI Nájemní kritéria

## Vysokopevnostní podpěra HD 200

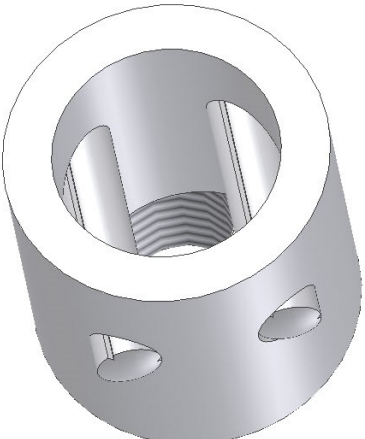

Hlava HDK 45	Popis	Instrukce	Fakturace	Typ
	<b>04.10.14 Spona pásů HD</b> <ul style="list-style-type: none"> <li>■ Chybí</li> </ul>			
	<ul style="list-style-type: none"> <li>■ Je poškozeno silou</li> </ul>			
	<b>04.10.15 Deska</b> <ul style="list-style-type: none"> <li>■ Chybí</li> </ul>			
	<ul style="list-style-type: none"> <li>■ Je poškozeno silou</li> </ul>			

Hlava HDK 45	Popis	Instrukce	Fakturace	Typ
	<b>04.10.16 Pojistné háky HD</b>			
	<ul style="list-style-type: none"> <li>■ Chybí</li> </ul>			
	<b>04.10.17 Napínací vložka 6x20   Válc. rýh. Kolík 10x5</b>			
	<ul style="list-style-type: none"> <li>■ Chybí</li> </ul>			
	<ul style="list-style-type: none"> <li>■ Je poškozeno silou</li> </ul>			

Adaptér k patce HD (022019)	Popis	Instrukce	Fakturace	Typ
	<b>04.10.18 Poškozený závit</b>	 Oprava závitu		
	<ul style="list-style-type: none"> <li>■ Je-li možno</li> </ul>			
	<b>04.10.19 Válc. rýh. Kolík 10x5 chybí</b>	 780150 (Válc. rýh. Kolík 10x5 )		

### Adaptér k patce HD (022019)

Popis

Instrukce

Fakturace

Typ

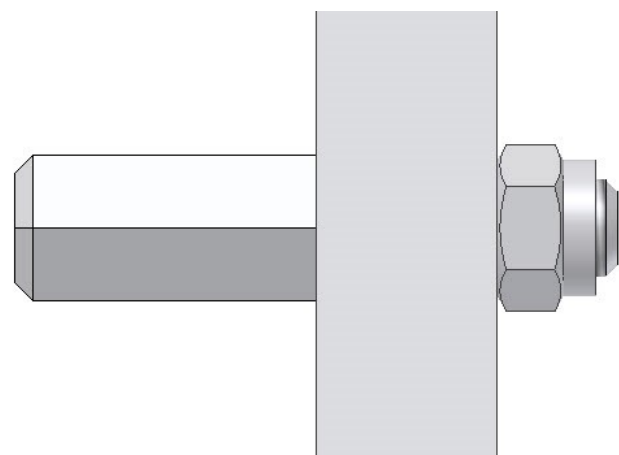

04.10.20 Kolík šestihr. 24x100 | Matice Chybí







710352 (Kolík šestihr. 24x100 )  
070890 (Matice)



# PERI Nájemní kritéria

## Vysokopevnostní podpěra HD 200



Nosník HDT (022008   022009   022010)	Popis	Instrukce	Fakturace	Typ
	04.10.21 Čep   Upínací vložka   Závlačka chybí	 105435 (Čep 50x330) 710618 (Závlačka 8) 722457 (Upínací vložka 5x35)		
 <p data-bbox="174 1139 293 1225">Nominal Dimension 220 mm</p>	04.10.22 Ohnuté spojovací plochy			

# PERI Nájemní kritéria

## Vysokopevnostní podpěra HD 200



Nosník HDT (022008   022009   022010)	Popis	Instrukce	Fakturace	Typ
---------------------------------------	-------	-----------	-----------	-----





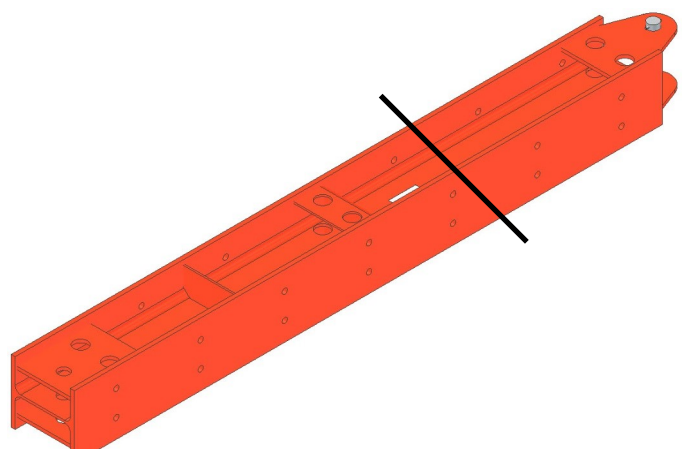









04.10.23 Zřezy v nosníku



04.10.24 Zkrácený nosník











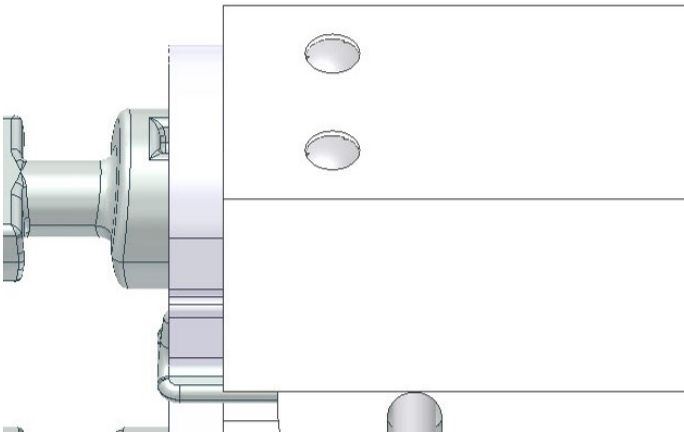

Hlava pro stabilizátor HD (022022)	Popis	Instrukce	Fakturace	Typ
	<b>04.10.25 Deska   Spojka pásů HD</b>	 780143 (Spojka pásů HD) 780151 (Deska)		
	<ul style="list-style-type: none"> <li>■ Chybí</li> </ul>	 780143 (Spojka pásů HD) 780151 (Deska)		
	<b>04.10.26 Pojistný hák HD   Napínací vložka 8x70</b>	 780144 (Pojistný hák HD) 770013 (Nap. vložka 8x70)		
	<ul style="list-style-type: none"> <li>■ Chybí</li> </ul>	 780144 (Pojistný hák HD) 770013 (Nap. vložka 8x70)		
<ul style="list-style-type: none"> <li>■ Je poškozeno silou</li> </ul>				

# PERI Nájemní kritéria

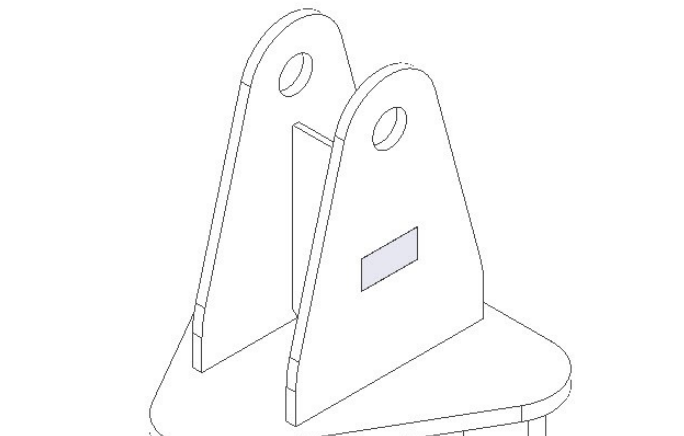
## Vysokopevnostní podpěra HD 200









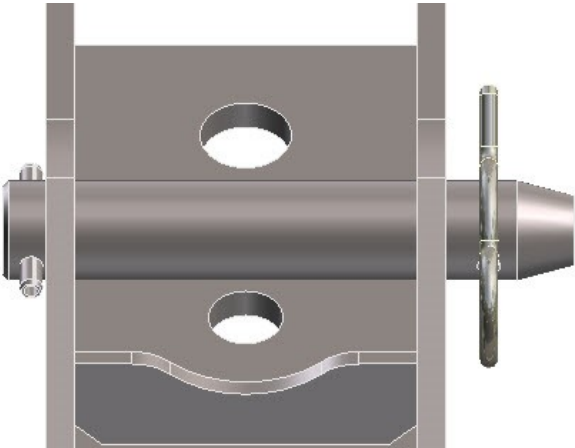

Hlava pro stabilizátor HD (022022)	Popis	Instrukce	Fakturace	Typ
	04.10.27 Válc. rýh. Kolík 10x5 chybí	 780150 (Válc. rýh. Kolík 10x5 )		
	04.10.28 Ohnuté patky			

# PERI Nájemní kritéria

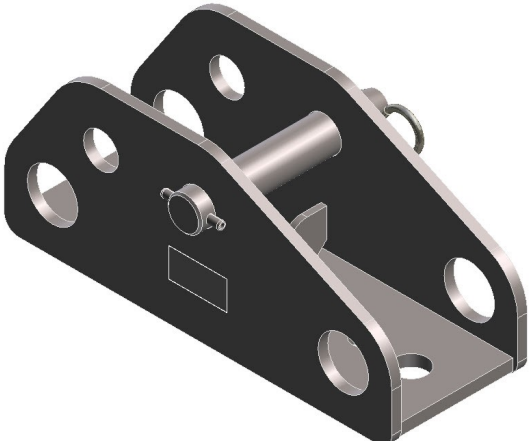
## Vysokopevnostní podpěra HD 200















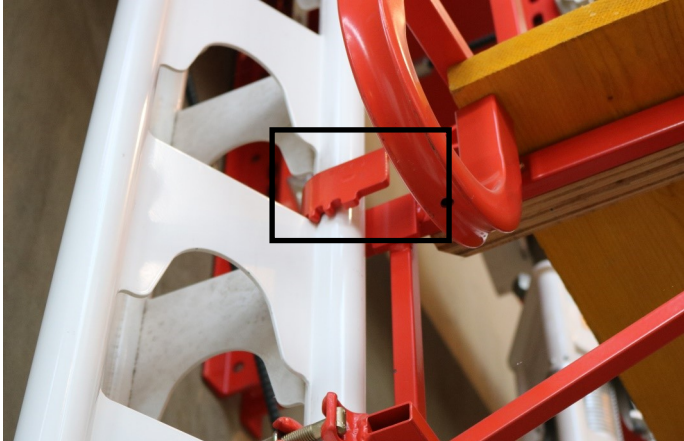



Patka HD (022024)	Popis	Instrukce	Fakturace	Typ
	<p>04.10.29 Čep   Nap. Vložka 8x60   Závlačka chybí</p>	<p> 722465 (Čep 35x160) 710304 (Závlačka 7) 770012 (Nap. Vložka 8x60)</p>	<p></p>	<p></p>
	<p>04.10.30 Ohnutý prvek</p>	<p></p>	<p></p>	<p></p>

# PERI Nájemní kritéria

## Vysokopevnostní podpěra HD 200



Konzola 75 HD (022017)	Popis	Instrukce	Fakturace	Typ
	<b>04.10.31 Šroub 14x70  Matice chybí</b>	 131316 (Šroub 14x70) 710340 (Matice)		
	<b>04.10.32 Ohnutá spojka</b>	<ul style="list-style-type: none"> <li>■ Je-li možno </li> </ul>		
	<ul style="list-style-type: none"> <li>■ Nelze opravit</li> </ul>	 		
	<ul style="list-style-type: none"> <li>■ Prasklina ve sváru</li> </ul>	 		

Konzola 75 HD (022017)	Popis	Instrukce	Fakturace	Typ
------------------------	-------	-----------	-----------	-----

04.10.33 Přibíjecí deska



715044 (Přibíjecí deska)



# PERI Nájemní kritéria

## Vysokopevnostní podpěra HD 200



Úchyt pro stabilizátor HDR   2 (022016   131723)	Popis	Instrukce	Fakturace	Typ
--	-------	-----------	-----------	-----



04.10.34 Šroub 14x70 | Matice chybí



131316 (Šroub 14x70)  
710340 (Matice)







04.10.35 Čep 16x42 | Závlačka Chybí



027170 (Čep 16x 42 )  
018060 (Závlačka 4/1)



















Úchyt pro stabilizátor HDR   2 (022016   131723)	Popis	Instrukce	Fakturace	Typ
	<b>04.10.36 Ohnutá spojka</b>			
	■ Je-li možno			
	■ Nelze opravit	 		

# PERI Nájemní kritéria

## Vysvětlivky znaků



Znak	Význam	Znak	Význam	Znak	Význam
	Není v pořádku – materiál je poškozený		Fakturuje se zákazníkovi		Optické poškození
	OK – materiál zůstává v nájemním skladu		Nefakturuje se zákazníkovi		Funkční poškození
	Poškozený materiál – <b>není dovoleno</b> vydávat materiál z bezpečnostních důvodů		Zkrácení prvku		Funkční poškození — <b>není dovoleno</b> vydávat materiál z bezpečnostních důvodů
	Oprava dle instrukcí		Označení prvku barvou		Statické poškození — <b>není dovoleno</b> vydávat materiál z bezpečnostních důvodů
	Oprava za studena — poté kontrola svárů a sousedních dílů		Výměna poškozeného dílu		
	Oprava po výpočtu hospodárnosti		Doplnění chybějícího dílu		
	Očištění materiálu				