

# PERI Nájemní kritéria

## Sloupové bednění QUATTRO



### Kontakt

**PERI, spol. s r.o.**  
**bednění lešení služby**

Průmyslová 392  
252 42 Jesenice u Prahy  
tel.: 222 359 311  
info@peri.cz  
www.peri.cz

Obsah	Strana
Překližka	2
Rám	6
Betonářská plošina	9
Jeřábový závěs pro betonářskou plošinu	13
Žebřík 180/6	16
Pojezdové kolečko QUATTRO	17
Upínací kotva QUATTRO	18
Úchyt pro stabilizátor QUATTRO	19
Žebříkové připojení QUATTRO	20

Poslední změny	Datum   Iniciály	Strana
Nová verze	10/2015 I fw	

# PERI Nájemní kritéria

## Sloupové bednění QUATTRO



### Panel QUATTRO

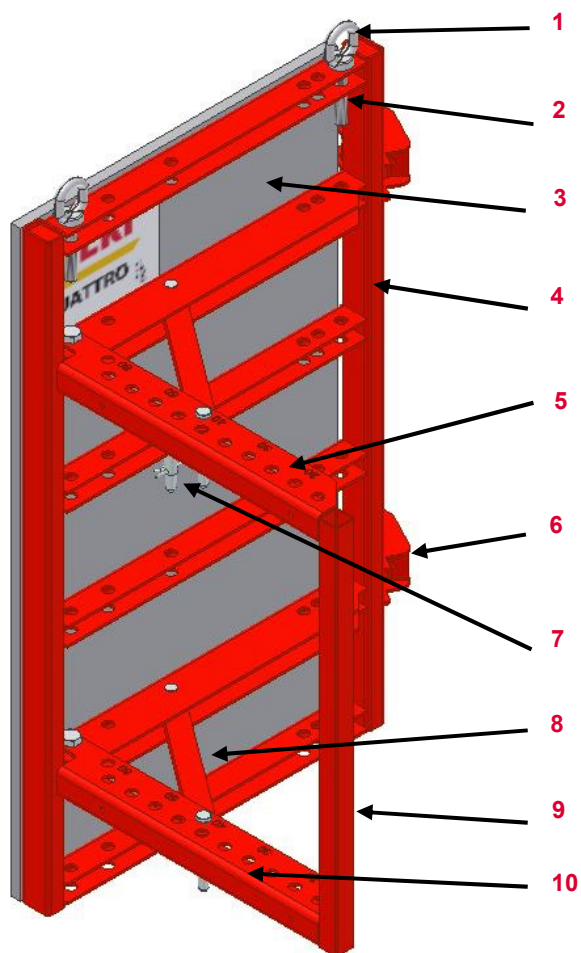















Č.	Popis	Číslo výrobku
1	Šroub s okem	724812
2	Matice M20	710045
3	Překližka	
4	Ocelový rám	
5	Hrablo	
6	Upínací spona QE	724447
7	Čep	105400
8	Vzpěra QE	725568
9	Profil hrabla	
10	Děrovaná závora QE	
Platné pro:		Číslo výrobku
Panel QUATTRO QES 125		109924
Panel QUATTRO QES 275		109925
Panel QUATTRO QES 350		109926
Panel QUATTRO QES 50		109923

# PERI Rental Criteria

## Sloupové bednění QUATTRO









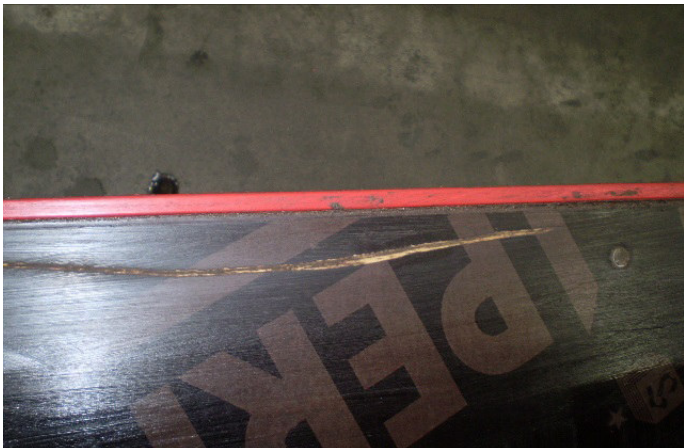

Překližka	Popis	Instrukce	Fakturace	Typ
	<b>17.20.01 Díry od hřebíků</b>			
	<ul style="list-style-type: none"> <li>■ Díry od hřebíků z lícové strany</li> <li>■ Díry od hřebíků z rubové strany</li> </ul>	 	 	 
	<b>17.20.02 Díry</b>			
	<ul style="list-style-type: none"> <li>■ <math>\leq \text{Ø } 35 \text{ mm}</math></li> <li>■ <math>&gt; \text{Ø } 35 \text{ mm}</math></li> </ul>	 	 	 
			084223 084222 084221 084220	

# PERI Nájemní kritéria

## Sloupové bednění QUATTRO











Překližka	Popis	Instrukce	Fakturace	Typ
	<b>17.20.03 Rýhy a škrábance</b>  ■ > 1 mm hloubky			
	<b>17.20.04 Poškození hrany</b>  ■ > 5 mm			

# PERI Nájemní kritéria

## Sloupové bednění QUATTRO



Překližka	Popis	Instrukce	Fakturace	Typ
	17.20.05 Poškození teplem nebo svařováním		 084223 084222 084221 084220	
	17.20.06 Neodstranitelné znečištění		 084223 084222 084221 084220	

# PERI Nájemní kritéria

## Sloupové bednění QUATTRO



Rám	Popis	Instrukce	Fakturace	Typ
	<p>17.20.07 Panel prohnutý diagonálně</p> <ul style="list-style-type: none"><li>■ Rozdíl A k B &gt; 10 mm</li></ul>			
	<p>17.20.08 Deformovaný rám</p> <ul style="list-style-type: none"><li>■ &gt; 6 mm</li></ul>			

# PERI Nájemní kritéria

## Sloupové bednění QUATTRO

















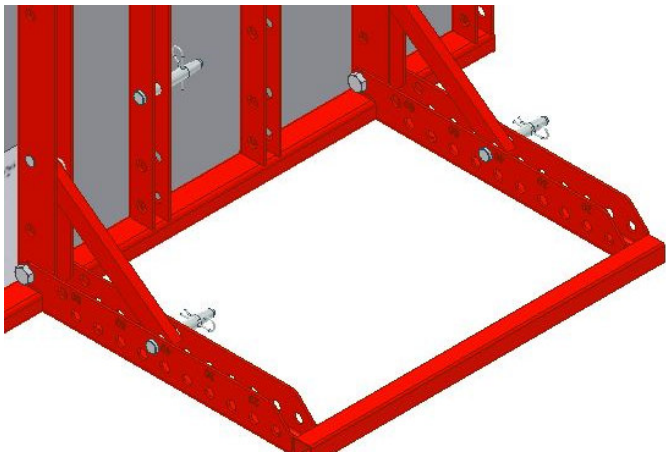

Rám	Popis	Instrukce	Fakturace	Typ
<p><b>QE 125</b> <b>Rahmen verbogen</b></p>	<b>17.20.09 Ohnutý příčný profil</b> <ul style="list-style-type: none"> <li>■ Oprava je možná</li> </ul>		088244	
	<ul style="list-style-type: none"> <li>■ Oprava není možná</li> </ul>		0883589	
	<b>17.20.10 Ohnutý ochranný plech</b> <ul style="list-style-type: none"> <li>■ Oprava je možná</li> </ul>		088244	
	<ul style="list-style-type: none"> <li>■ Oprava není možná</li> </ul>		088292	

# PERI Nájemní kritéria

## Sloupové bednění QUATTRO



Rám	Popis	Instrukce	Fakturace	Typ
	<b>17.20.11 Ohnutá upínací spona</b>			
	<ul style="list-style-type: none"> <li>■ Oprava je možná</li> </ul>		 088244	
	<ul style="list-style-type: none"> <li>■ Oprava není možná</li> </ul>			
	<b>17.20.12 Hrablo</b>			
	<ul style="list-style-type: none"> <li>■ Zlomené hrablo nebo zničené otvory</li> </ul>		 088350 088354 088353	
	<ul style="list-style-type: none"> <li>■ Zlomená vzpěra</li> </ul>		 088350 088354 088353	
<ul style="list-style-type: none"> <li>■ Profil hrabla je zlomený</li> </ul>		 088350 088354 088353		



# PERI Nájemní kritéria

## Sloupové bednění QUATTRO



### Betonářská plošina (037400)

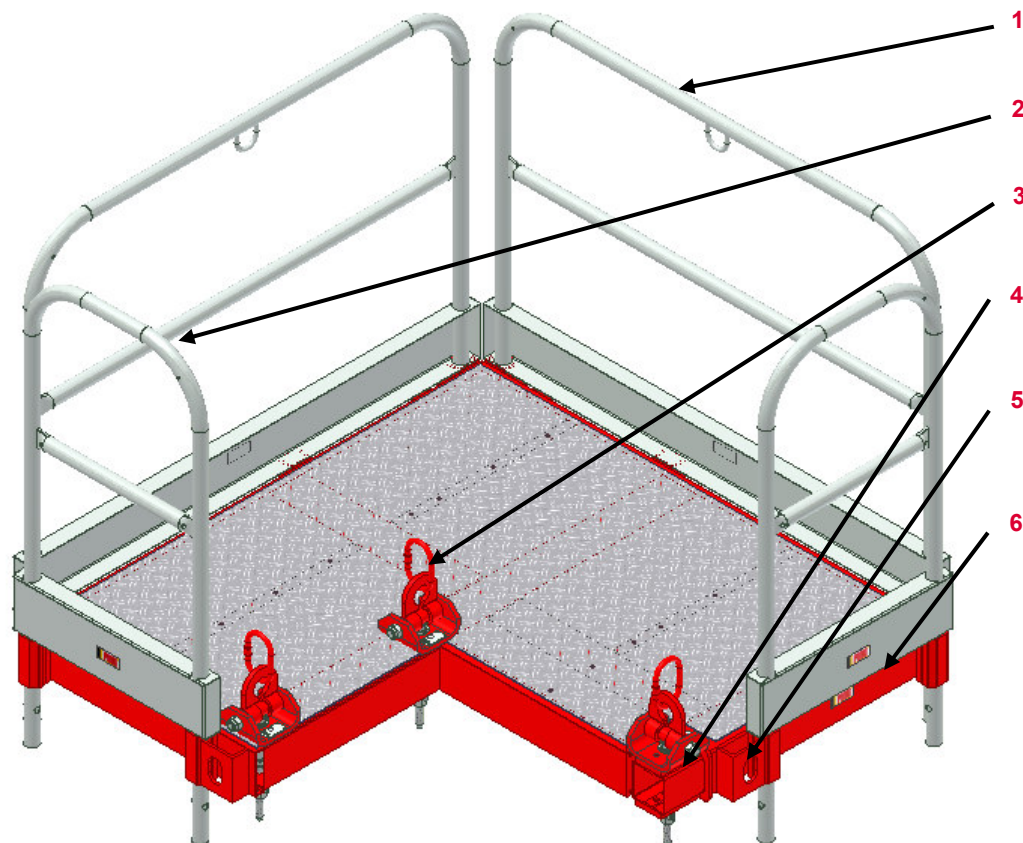









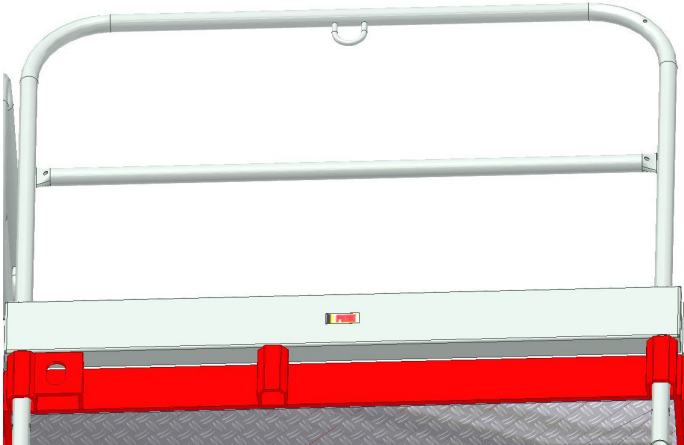





Č.	Popis	Číslo výrobku
1	Zábradlí plošiny 134	037430
2	Zábradlí plošiny 52	037420
3	Jeřábové oko	037440
4	Teleskopická trubka	786108
5	Zarážka zábradlí	
6	Podesta bet. plošiny	037410

# PERI Nájemní kritéria

## Sloupové bednění QUATTRO











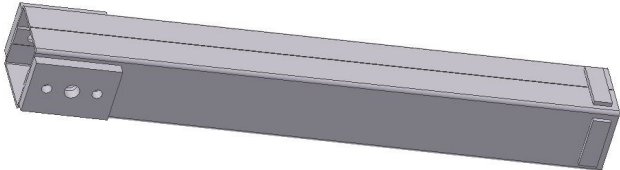



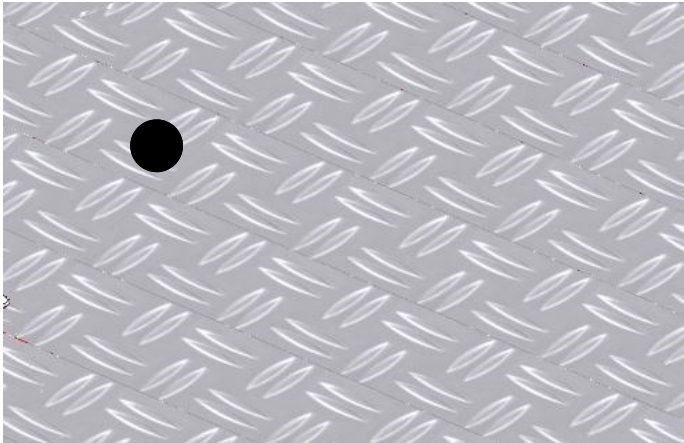

Betonářská plošina	Popis	Instrukce	Fakturace	Typ
	<b>17.20.13 Zábradlí plošiny 134</b> <ul style="list-style-type: none"> <li>Poškozené sváry</li> </ul>	 Zábradlí plošiny 134(037430)	 088590	
	<ul style="list-style-type: none"> <li>Zlomené zábradlí</li> </ul>	 Zábradlí plošiny 134 (037430)	 088590	
	<b>17.20.14 Zábradlí plošiny 52</b> <ul style="list-style-type: none"> <li>Poškozené sváry</li> </ul>	 Zábradlí plošiny 52 (037420)	 088589	
	<ul style="list-style-type: none"> <li>Zlomené zábradlí</li> </ul>	 Zábradlí plošiny 52 (037420)	 088589	

# PERI Rental Criteria

## Sloupové bednění QUATTRO

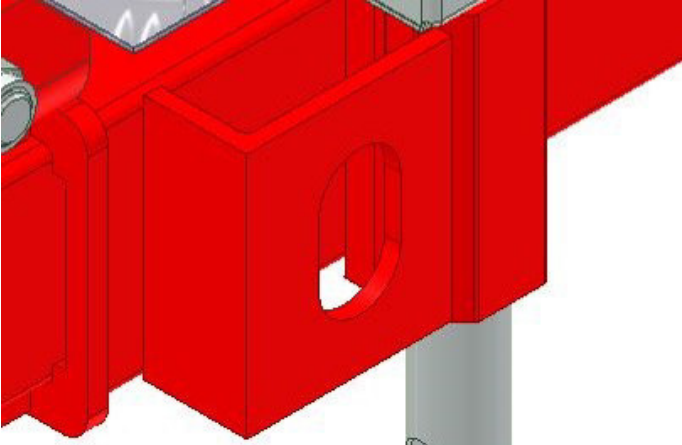

Betonářská plošina	Popis	Instrukce	Fakturace	Typ
	<b>17.20.15 Teleskopická trubka</b> <ul style="list-style-type: none"> <li>■ Ohnutá</li> </ul>	 Teleskopická trubka (786108)	 088582	
	<ul style="list-style-type: none"> <li>■ Poškozené otvory</li> </ul>	 Teleskopická trubka (786108)	 088582	
	<b>17.20.16 Díry v podestě</b> <ul style="list-style-type: none"> <li>■ ≤ 30 mm</li> </ul>			
	<ul style="list-style-type: none"> <li>■ &gt; 30 mm</li> </ul>	 		

Betonářská plošina	Popis	Instrukce	Fakturace	Typ
	<b>17.20.17 Držák sloupku zábradlí</b>			
	<ul style="list-style-type: none"> <li>■ Ohnutý bez prasklin v materiálu nebo sváru</li> </ul>		 088244	
	<ul style="list-style-type: none"> <li>■ Ohnutý s prasklinou v materiálu nebo sváru</li> </ul>			
	<b>17.20.18 Držák sloupku zábradlí</b>			
	<ul style="list-style-type: none"> <li>■ Ohnutý bez prasklin v materiálu nebo sváru</li> </ul>		 088244	
	<ul style="list-style-type: none"> <li>■ Ohnutý s prasklinou v materiálu nebo sváru</li> </ul>			

# PERI Nájemní kritéria

## Sloupové bednění QUATTRO



### Jeřábový závěs pro betonářskou plošinu (037440)

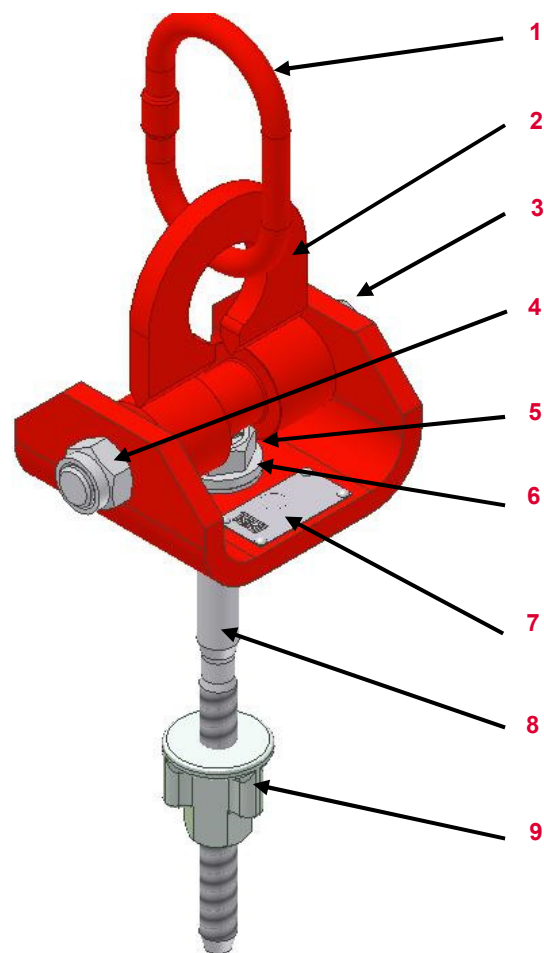















Č.	Popis	Číslo výrobku
1	Zavěšovací oko	
2	Jeřábové oko	
3	Šroub	781051
4	Matice	781053
5	Matice	105513
6	Podložka	781016
7	Štítek	710539
8	Stahovací šroub	054230
9	Palcová matice	030130

# PERI Nájemní kritéria

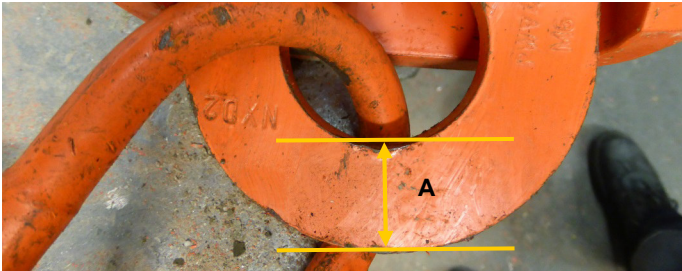
## Sloupové bednění QUATTRO













Zavěšovací oko	Popis	Instrukce	Fakturace	Typ
	<b>17.20.19 Štítek ztacený nebo nečitelný</b>	 Štítek (710539)  Nýty (767043)		
	<b>17.20.20 Tloušťka oka</b> ■ $\text{Ø} \leq 12,5 \text{ mm}$	 		
	<b>17.20.21 Jeřábové oko</b> ■ $A \leq 22,5 \text{ mm}$	 		

# PERI Nájemní kritéria

## Sloupové bednění QUATTRO



Jeřábový závěs	Popis	Instrukce	Fakturace	Typ
	17.20.22 Poškozená palcová matice	 Palcová matice (030130)		
	17.20.23 Poškozený nebo ohnutý stahovací šroub	 Stahovací šroub (054230)		
	17.20.24 Jeřábové oko	 Naolejovat		

# PERI Nájemní kritéria

## Sloupové bednění QUATTRO













Žebřík 180/6 (051410)	Popis	Instrukce	Fakturace	Typ
	<p><b>17.20.25 Ohnuté nášlapy</b></p> <ul style="list-style-type: none"> <li>■ &gt; 3 mm</li> </ul>			
	<p><b>17.20.26 Poškozené sváry</b></p> <ul style="list-style-type: none"> <li>■ Bez deformací na nosném profilu</li> <li>■ S deformacemi na nosném profilu</li> </ul>			

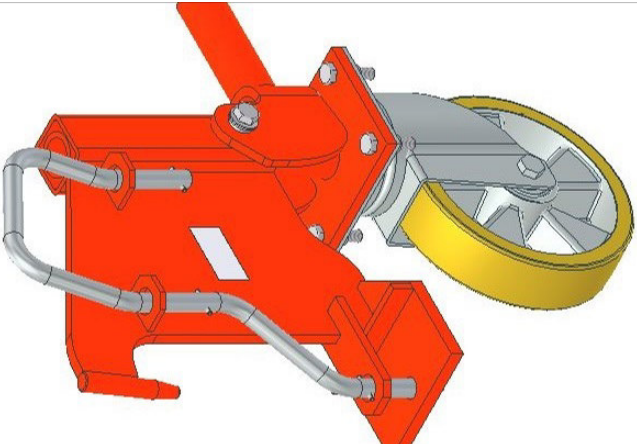

# PERI Nájemní kritéria

## Sloupové bednění QUATTRO



Pojzdové kolečko QUATTRO (105791)	Popis	Instrukce	Fakturace	Typ
	<b>17.20.27 Kolečko</b> <ul style="list-style-type: none"> <li>■ ojeté</li> <li>■ Poškození hrubým zacházením</li> </ul>	 Kolečko (105783)		
	 Kolečko 105783)			
	<b>17.20.28 „Griff“ ohnutý nebo poškozený</b>	 Griff (105758) Upínací vložka (710683)		

# PERI Nájemní kritéria

## Sloupové bednění QUATTRO



Upínací kotva QUATTRO (037540)	Popis	Instrukce	Fakturace	Typ
	17.20.29 Ohnutá vidlice		088244	
	17.20.30 Poškozená trojkřídlá matice			

# PERI Nájemní kritéria

## Sloupové bednění QUATTRO



### Úchyt pro stabilizátor QUATTRO (037530)

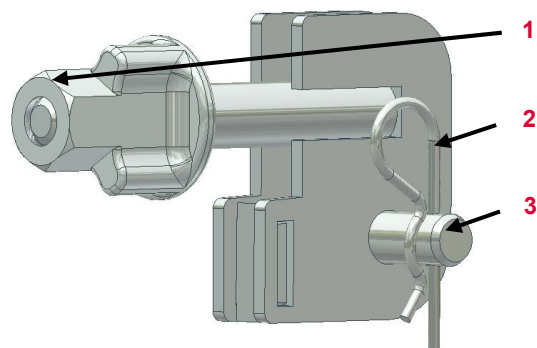

Č.	Popis	Číslo výrobku
1	Palcová matice	030130
2	Závlačka	018060
3	Čep	027170

### Poškození

Popis	Instrukce	Fakturace	Typ
-------	-----------	-----------	-----

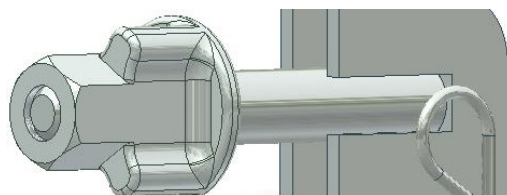

17.20.31 Poškozená palcová matice



Palcová matice (030130)



088429

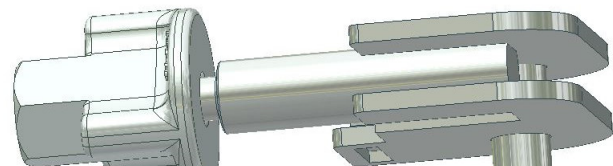

17.20.32 Ohnutí



088244



# PERI Nájemní kritéria

## Sloupové bednění QUATTRO



### Žebříkové připojení QUATTRO (103391)

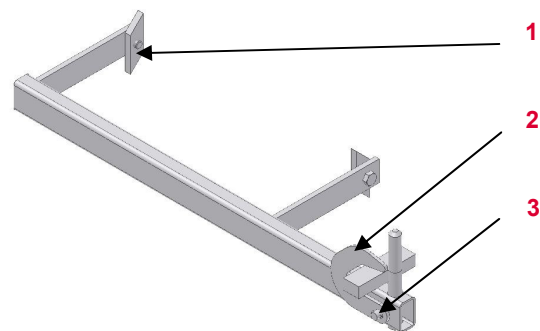

Č.	Popis	Číslo výrobku
1	Upínací plech	701763
2	Vidlice	104076
3	Objímka	780803

### Poškození

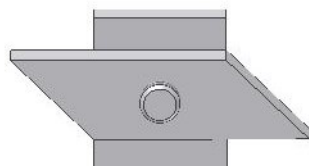

**Popis**  
17.20.33 Poškozený nebo ohnutý upínací plech



**Instrukce**  
Upínací plech (701763)  
Šroub(710266)



**Fakturace**  
088295



**Typ**

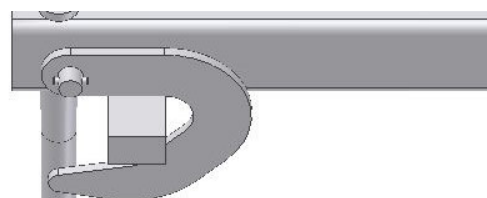

**Popis**  
17.20.34 Poškozená nebo ohnutá vidlice



**Instrukce**  
Vidlice (104076)  
Objímka(780803)



**Fakturace**  
088291



# PERI Nájemní kritéria

## Vysvětlivky znaků



Znak	Význam	Znak	Význam	Znak	Význam
	Není v pořádku – materiál je poškozený		Fakturuje se zákazníkovi		Optické poškození
	OK – materiál zůstává v nájemním skladu		Nefakturuje se zákazníkovi		Funkční poškození
	Poškozený materiál – <b>není dovoleno</b> vydávat materiál z bezpečnostních důvodů		Zkrácení prvku		Funkční poškození — <b>není dovoleno</b> vydávat materiál z bezpečnostních důvodů
	Oprava dle instrukcí		Označení prvku barvou		Statické poškození — <b>není dovoleno</b> vydávat materiál z bezpečnostních důvodů
	Oprava za studena — poté kontrola svárů a sousedních dílů		Výměna poškozeného dílu		
	Oprava po výpočtu hospodárnosti		Doplnění chybějícího dílu		
	Očištění materiálu				