

PERI Nájemní kritéria SKYDECK

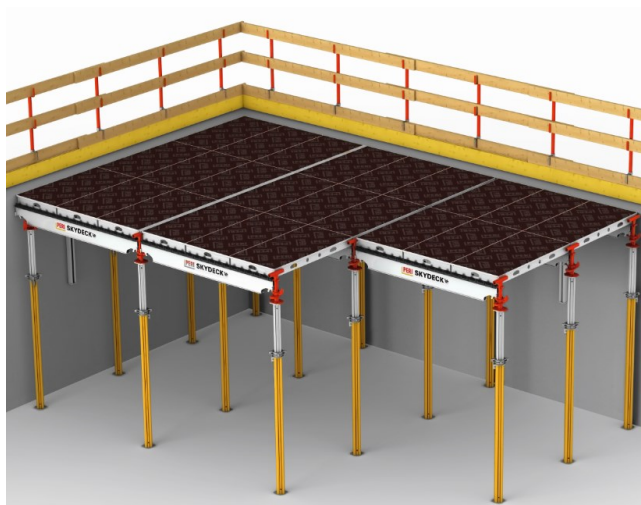

Kontakt

PERI, spol. s r.o.
bednění lešení služby
Prumyslová 392
252 42 Jesenice u Prahy
tel.: 222 359 311
info@peri.cz
www.peri.cz

Obsah	Strana	Provedené změny	Datum Autor	Str.
Rám SDP	2	Nová verze	09/2015 cg	
Podélný nosník SLT	9	Přidány prasklé sváry na hlavách 21.49	05/2017 fw	
Krycí lišta SAL	17	Přidána SKY-Kotva	01/2018 fw	
Pevná hlava SSK Opěrná hlava SCK Padací hlava SFK	19	Přidáno kritérium pro držák hlav	01/2018 fw	
Koncový nosník SRT-2	29	Změna obrázků	05/2018 fw	
Trojúhelníkový rám SDR	31	Nové kritéria na panely	06/2019 fw	
Stěnový držák SWH-2	34	Přidán napínací řetěz a napínací očko SAO	06/2019 fw	
SKY-Kotva	36	Přidána koncová podpora SSL	06/2019 fw	
Lávka SDB	40	Sky Kotva Variabilní základna přidána	01/2022 fw	40

PERI Nájemní kritéria SKYDECK



SKYDECK Panel SDP	Číslo	Jméno	Číslo výrobku
-------------------	-------	-------	---------------

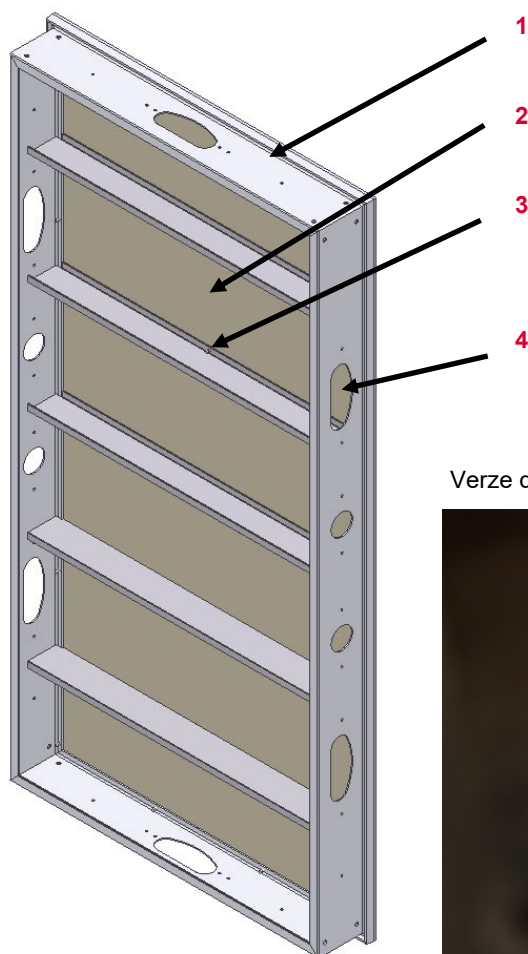

Platné pro:	Číslo výrobku
Panel SDP 150 x 75	061000
Panel SDP 150 x 50	061011
Panel SDP 150 x 37,5	061020
Panel SDP 75 x 75	061010
Panel SDP 75 x 50	061013
Panel SDP 75 x 37,5	061030











1	Rám	
2	Překližka	
3	Nýt	780305
4	Držadlo	









Verze do roku 2018 s krátkým svárem



Verze od roku 2018 s dlouhým svárem



Panel SDP	Popis	Instrukce	Fakturace	Typ	
	Prasklý svár v rohu překližky	<ul style="list-style-type: none"> ■ Je-li možno opravit a dodržet úhel 90° 		088028	
	<ul style="list-style-type: none"> ■ Nelze opravit 			088027	
	Prasklý a otevřený roh Vytržené části (Nelze spravit pouze zatřením barvou)				









Panel SDP	Popis	Instrukce	Fakturace	Typ
	Svařování na spodní hraně rohu (V nové verzi panelů není spodní hrana svařena)			
	Prasklina ve sváru z vnější strany panelu		 088028	



Panel SDP	Popis	Instrukce	Fakturace	Typ	
	<p>Prasklý svár ze spodní strany rámu na překližky</p>				
	<p>Prasklina nebo díra</p>	<ul style="list-style-type: none"> ■ ≤ Ø 5 mm ■ Or ≤ 5 mm délky 			
	<ul style="list-style-type: none"> ■ Or > Ø 5 mm ■ Or > 5 mm délky 			<p>088028</p>	

Panel SDP	Popis	Instrukce	Fakturace	Typ
	Prasklina ve sváru výztuhy <ul style="list-style-type: none">■ Bez poškození výztuhy			
	Deformace výztuhy <ul style="list-style-type: none">■ S deformací na výztuze		 088028	

PERI Nájemní kritéria SKYDECK



Panel SDP	Popis	Instrukce	Fakturace	Typ
	Promáčknutí profilu			
	Promáčknutí na spodní straně rámu ■ ≥ 3 mm		 088027	

Panel SDP	Popis	Instrukce	Fakturace	Typ
	Održené části v držadle			
	Prasklina v části držadla			088028 

PERI Nájemní kritéria SKYDECK





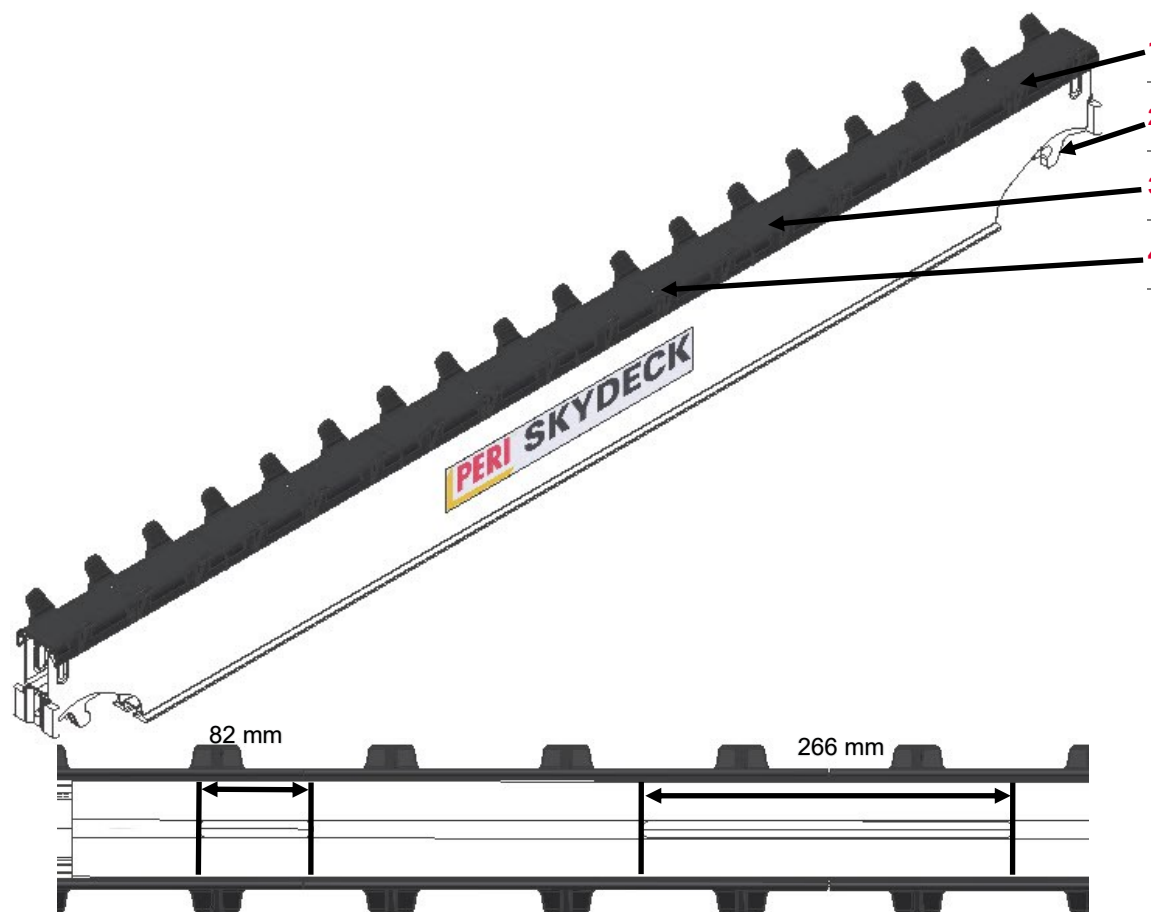





Podélný nosník SLT	Číslo	Jméno	Číslo výrobku
--------------------	-------	-------	---------------



1	Plastový koncový kus	061410
2	Připojení	
3	Plastový střední díl	061400
4	Nýt 5x12	780012

Platné pro	
Podélný nosník SLT 150	061110
Podélný nosník SLT 225	061100
Podélný nosník SLT 375	061160

Podélný nosník SLT	Popis	Instrukce	Fakturace	Typ
	<p>Poškození plastového kusu</p>		088319	
	<p>Ohnuté připojení podélného nosníku</p> <p>■ > 5 mm</p>		088333	

Podélný nosník SLT	Popis	Instrukce	Fakturace	Typ
	<p>Prasklý svár v místě připojení</p> <ul style="list-style-type: none"> Prasklina skrz vnější i vnitřní stranu profilu. Prasklina lze vidět z vnitřní strany připojení. 			
	<p>Prasklý svár v místě připojení</p> <ul style="list-style-type: none"> Prasklina pouze ve vnější hraně připojení 			<p>088331</p> 

Podélný nosník SLT	Popis	Instrukce	Fakturace	Typ
--------------------	-------	-----------	-----------	-----



Prasklý svár v místě připojení

- Prasklina v staticky namáhaném sváru



Ohnutí podélného nosníku

- < 3 mm a napínací očko SAO pohyblivé



088244



- ≥ 3 mm a lze srovnat



088244













- Nebo nelze narovnat



Podélný nosník SLT	Popis	Instrukce	Fakturace	Typ
	<p>Díra ve vnitřku podélného nosníku</p> <ul style="list-style-type: none"> ■ Bez deformace profilu 	 Narovnat pomocí majzlíku		
	<p>Deformovaný profil</p>	 		

Podélný nosník SLT	Popis	Instrukce	Fakturace	Typ
	Prasklina ve vnitřku profilu			
	■ < 15 mm délky			
■ ≥ 15 mm délky	Díra v profilu			
■ ≤ Ø 5 mm	■ > Ø 5 mm			

Podélný nosník SLT	Popis	Instrukce	Fakturace	Typ
	<p>Ohnutá vodící lišta (Napínací očko SAO musí být pohyblivé v celé délce)</p>		 088244	
	<p>Ohnutá příruba profilu</p>		 088244	
	<ul style="list-style-type: none"> ■ Bez prasklin v materiálu 			
	<ul style="list-style-type: none"> ■ Prasklý materiál 			

Podélný nosník SLT	Popis	Instrukce	Fakturace	Typ
	Prasklina ve vnější vrstvě připojení	 		

PERI Nájemní kritéria SKYDECK





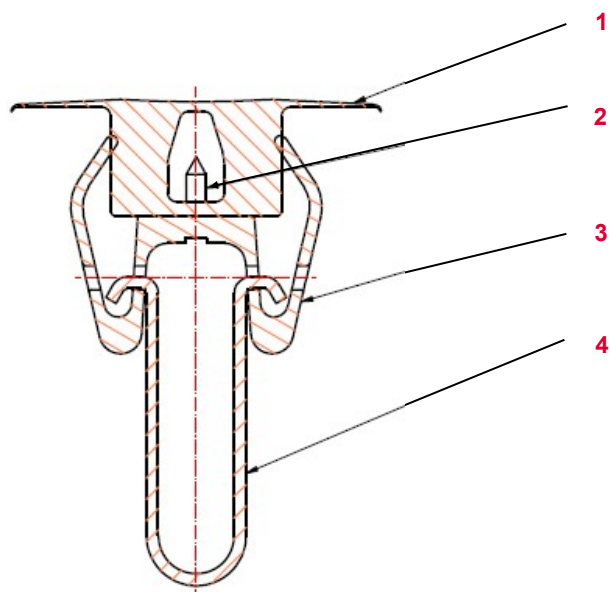
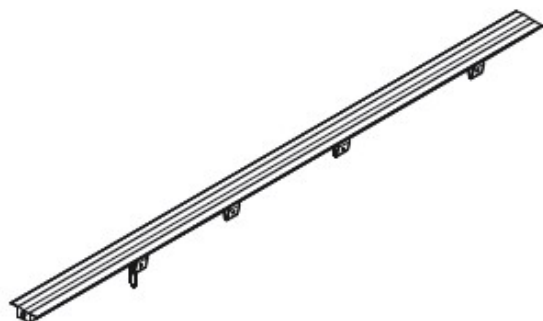







Krycí lišta SAL	Číslo	Jméno	Číslo výrobku
-----------------	-------	-------	---------------



1	Profil	785196
2	Šroub	108780
3	Pružina	110736
4	Třmen RD 2,5 SAL	110735

Platné pro:

Krycí lišta SAL 150	061026
Krycí lišta SAL 75	061027
Krycí lišta SAL 50	061024
Krycí lišta SAL 37,5	061038

Vytržená I Chybějící součásti	Popis	Instrukce	Fakturace	Typ
	<p>Vytržená část</p> <ul style="list-style-type: none"> ■ > 10 cm 			
	<p>Chybějící součásti</p> <ul style="list-style-type: none"> ■ Chybějící pružina ■ Chybějící třmen 			
		110736	088302	
				
		110735	088303	

Pevná hlava SSK I Opěrná hlava SCK I Padací hlava SFK

Číslo Jméno Číslo výrobku

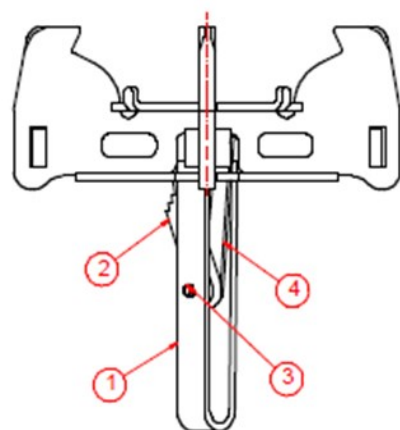

SSK

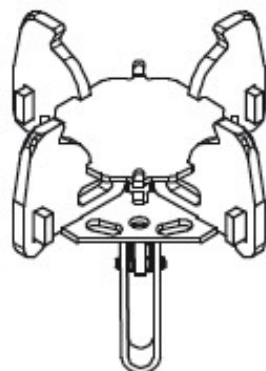

SFK

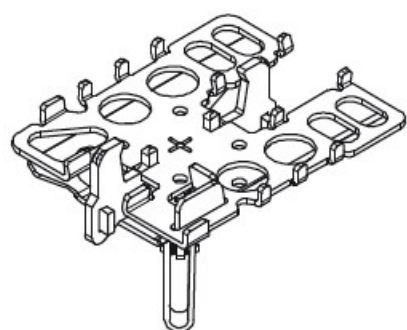

SCK

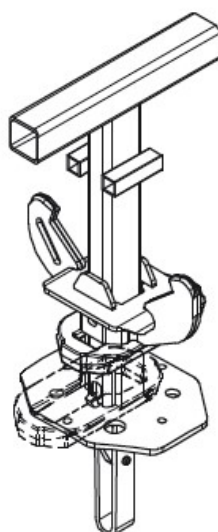









1	Držák hlavy	721325
2	Klapka	721321
3	Čep	721332
4	Pružina	721330

Valid for:

Pevná hlava SSK	061200
Opěrná hlava SCK	061180
Padací hlava SFK	061210

PERI Nájemní kritéria SKYDECK



Deformace	Popis	Instrukce	Fakturace	Typ
	Utržená část			
	Poškozená pružina	 721330	 088304	

PERI Nájemní kritéria SKYDECK



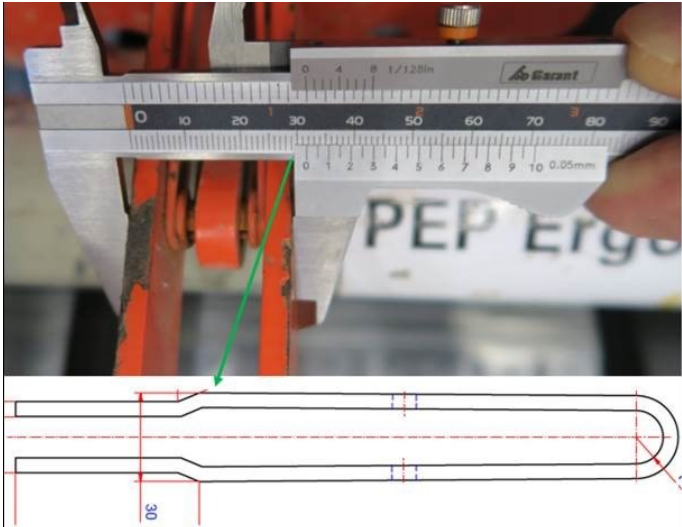









Deformace	Popis	Instrukce	Fakturace	Typ
	<p>Roztažený držák hlavy</p> <ul style="list-style-type: none"> ■ ≤ 30 mm ■ > 30 mm 			
				<p>088244</p>

PERI Nájemní kritéria

SKYDECK



Hlavy	Popis	Instrukce	Fakturace	Typ
	Výrazné ohnutí Uřezáno	 		
	Výrazně ohnutý držák hlavy	 		

Pevná hlava SSK	Popis	Instrukce	Fakturace	Typ
-----------------	-------	-----------	-----------	-----



Poškozený svár pod držákem hlavy

- S deformací držáku hlavy





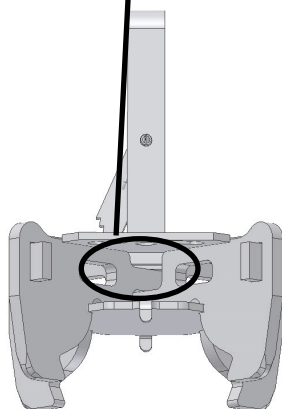





- Bez deformace držáku hlavy











PERI Nájemní kritéria SKYDECK



Opěrná hlava SCK	Popis	Instrukce	Fakturace	Typ
	Značné ohnutí části			
	Značné ohnutí nebo odtržení opěrné hlavy			









PERI Nájemní kritéria SKYDECK



Opěrná hlava SCK	Popis	Instrukce	Fakturace	Typ
	Značné ohnutí nebo zlomení držáku hlavy	 		
	Poškozená pružina	 721330	 088304	





PERI Nájemní kritéria SKYDECK



Padací hlava SFK	Popis	Instrukce	Fakturace	Typ
	Značné ohnutí			
	Ohnutý chybějící držák hlavy			

PERI Nájemní kritéria SKYDECK



Padací hlava SFK	Popis	Instrukce	Fakturace	Typ
	Chybějící pružina	 721330	 088304	

PERI Nájemní kritéria SKYDECK



Koncová Podpora SSL	Popis	Instrukce	Fakturace	Typ
---------------------	-------	-----------	-----------	-----



Vytržené části



Ohnuté části



PERI Nájemní kritéria SKYDECK



Koncový nosník SRT-2

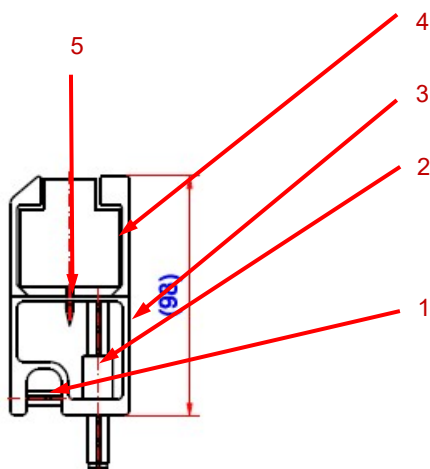
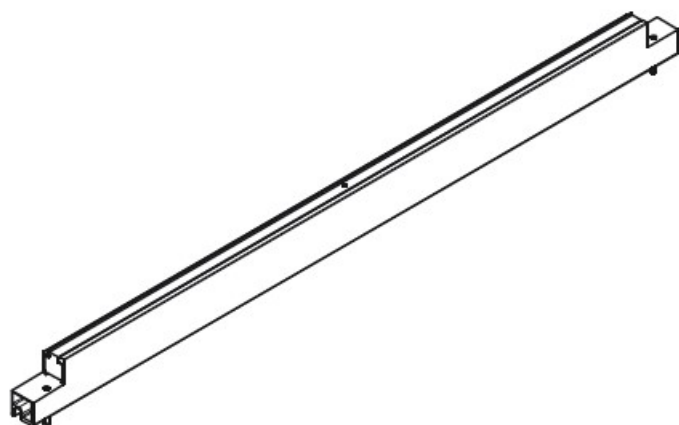

Číslo	Jméno	Číslo výrobku
1	Čep 6X20	780801
2	Čep 8X70	770013
3	Trubka	770009
4	Příložka	
5	Hřebík RNC-SB 28/60 NK	727285



Platné pro :

Koncový nosník SRT-2 150 061045

Koncový nosník SRT-2 75 061046

PERI Nájemní kritéria SKYDECK



Deformace Opatřované	Popis	Instrukce	Fakturace	Typ
	Praskliny v profilu Vytržené části			
	Rozpadlá příložka	 780130 (SRT 75) 780129 (SRT 150)	 088308 088307	

Trojúhelníkový rám SDR	Číslo	Jméno	Číslo výrobku
------------------------	-------	-------	---------------

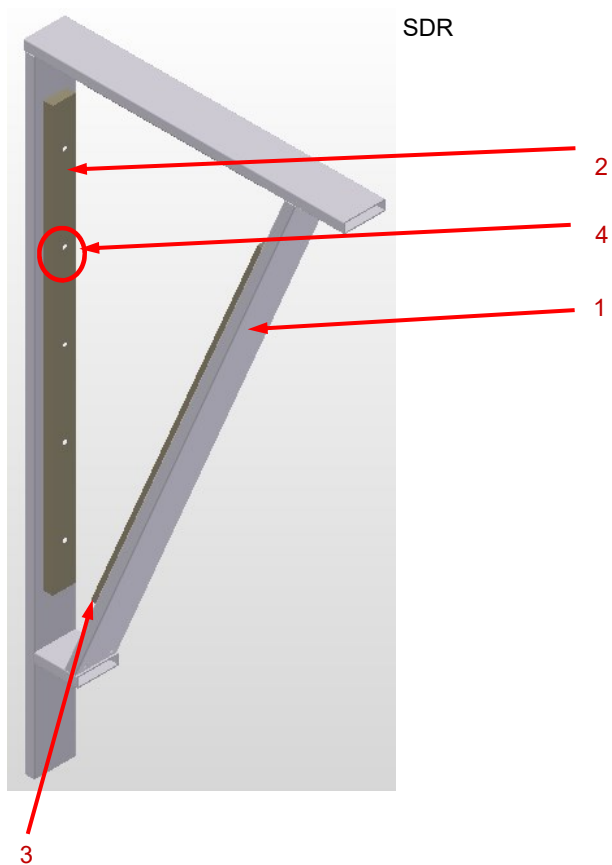

1	Rám SDR 150 I 75	785140
2	Překližka 21X54X1000	770617
3	Překližka 21X54X400	770616
4	TSS-Torx 6X40	024540

Platné pro :

Trojúhelníkový rám SDR 150x75	361021
Trojúhelníkový rám SDR 75x75	361022

Trojúhelníkový rám SDR	Popis	Instrukce	Fakturace	Typ
------------------------	-------	-----------	-----------	-----



Prasklina ve sváru









088273



Poškozená překližka



Trojúhelníkový rám SDR	Popis	Instrukce	Fakturace	Typ
	Ohnutý rám			
	<ul style="list-style-type: none"> ■ $\geq 3\text{mm}$ a lze srovnat 			088244
	<ul style="list-style-type: none"> ■ Nelze srovnat 	 		

Stěnový držák SWH-2

Číslo

Jméno

Číslo výrobku

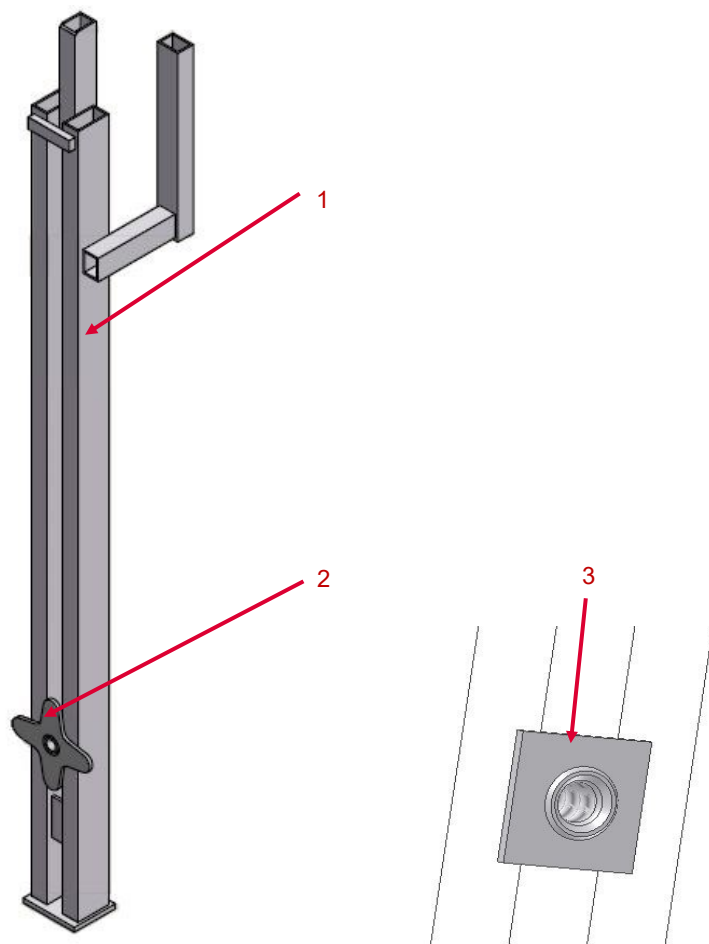

1 Stěnový držák SWH-2

2 Matice 715255

3 Plech 755204

Valid for:

SWH-2

061051

Stěnový držák SWH-2	Popis	Instrukce	Fakturace	Typ
	SWH-2 deformace			
	■ Poškozená trubka			
■ Poškozená chybějící matice nebo plech				

PERI Nájemní kritéria

SKYDECK





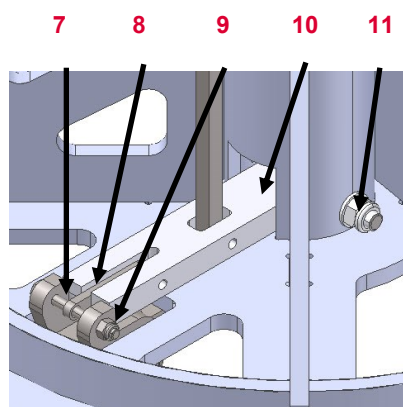
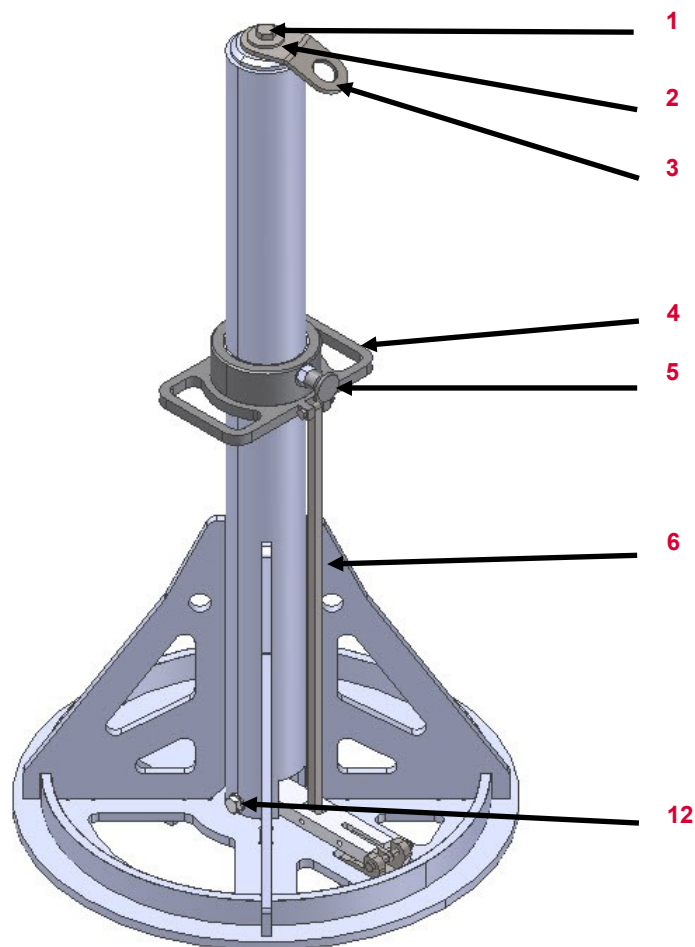











SKY-Kotva (131032)	Číslo	Jméno	BORNACK číslo výrobku
--------------------	-------	-------	-----------------------



1	Šroub	1003163
2	Podložka	1000070
3	Kotevní bod	1004255
4	Uzamykací pouzdro	1004266
5	Pojistný šroub	1004267
6	Tyč	1004254
7	Šroub	1004260
8	Plech	1004265
9	Matice	1004261
10	Uzamykací plech	1004263
11	Matice	1004028
12	Šroub	1004262

PERI Nájemní kritéria SKYDECK



SKY-Kotva (131032)	Popis	Instrukce	Fakturace	Typ
	<p>Kotevní bod</p> <ul style="list-style-type: none"> ■ Chybějící ■ Ohnutý 	<ul style="list-style-type: none">   	<ul style="list-style-type: none">   	<ul style="list-style-type: none">  
	<p>Šroub Podložka</p> <ul style="list-style-type: none"> ■ Chybějící ■ Poškozená 	<ul style="list-style-type: none">   	<ul style="list-style-type: none">   	<ul style="list-style-type: none">  

PERI Nájemní kritéria SKYDECK



SKY-Kotva (131032)	Popis	Instrukce	Fakturace	Typ
	Typový štítek			
	<ul style="list-style-type: none"> ■ Chybí 			
<ul style="list-style-type: none"> ■ Nelze přečíst 	Pojistný šroub			
<ul style="list-style-type: none"> ■ Chybějící 	<ul style="list-style-type: none"> ■ Nefunkční 			
	<ul style="list-style-type: none"> ■ Nefunkční 			

SKY-Kotva (131032)	Popis	Instrukce	Fakturace	Typ
	Ohnuté zesílené desky			
	<ul style="list-style-type: none"> ■ Funkční bez poškození svárů 			
	<ul style="list-style-type: none"> ■ Poškozené sváry 			
<ul style="list-style-type: none"> ■ Nefunkční 				
	Ohnuté pohyblivé části			
	<ul style="list-style-type: none"> ■ Funkční 			
<ul style="list-style-type: none"> ■ Nefunkční 				

PERI Nájemní kritéria SKYDECK



SKY-Kotva Variabilní základna (136615)

Číslo Jméno Číslo výrobku

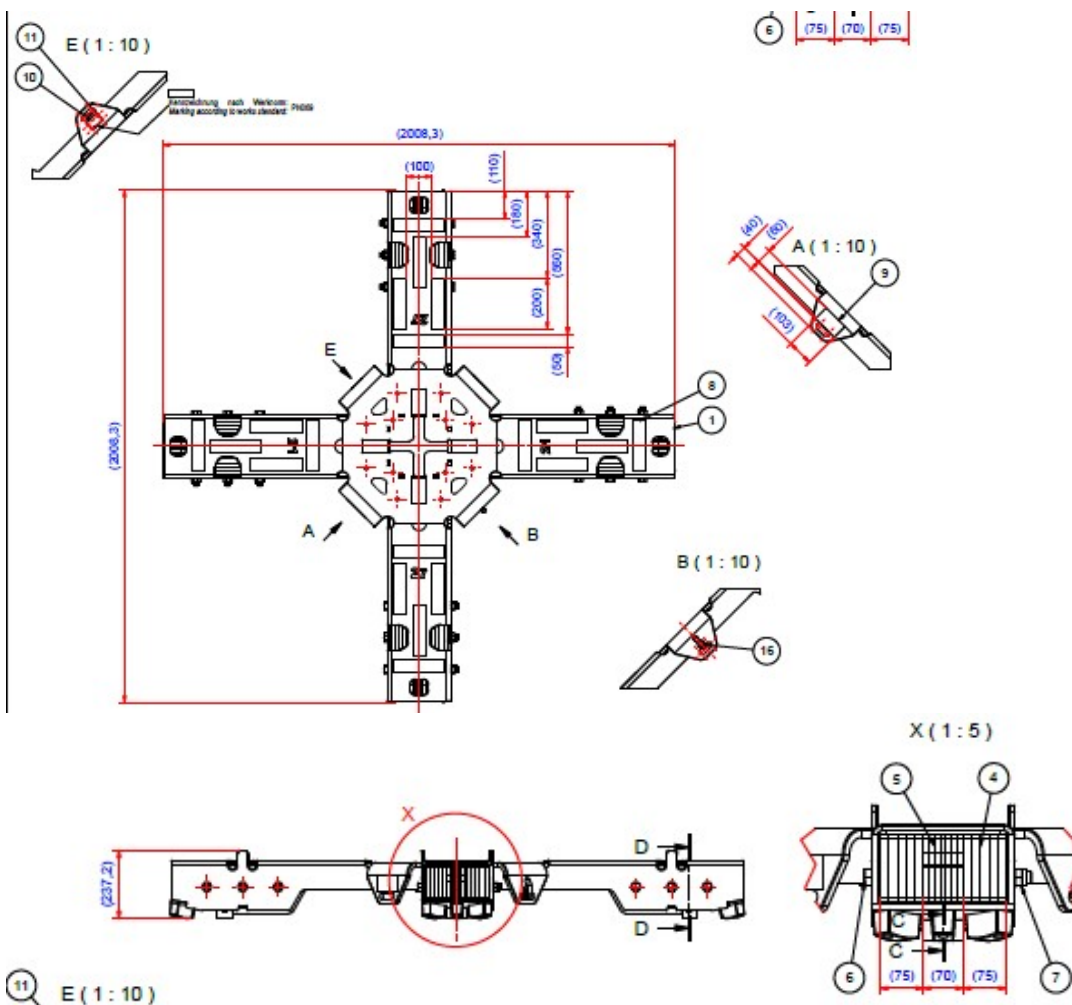

1	Podpůrný prvek	136611
2	Kolová zarážka	136612
3	Šroub M 6 x 16	136614
4	Balanční zátěž pravá	136604
5	Balanční zátěž levá	136603
6	Šroub M 20 x 280	725454
7	Matice M 20	130341
8	Varovný štítek	136715
9	Štítek PERI	133379
10	Typový štítek	136602
11	Nýt ISO 15977 3,2x4	130325
12	Gumová zarážka	136613
13	Šroub M 8 x 16	710416

PERI Nájemní kritéria SKYDECK



SKY-Kotva Variabilní základna (136615)	Popis	Instrukce	Fakturace	Typ
	Části základny			
	<ul style="list-style-type: none"> ■ chybí 			
	<ul style="list-style-type: none"> ■ Poškozeno silou 			
	Ohnuté části			
	<ul style="list-style-type: none"> ■ Lze narovnat 			
	<ul style="list-style-type: none"> ■ Nelze narovnat 			

PERI Nájemní kritéria SKYDECK



Lávka SDB	Číslo	Jméno	Číslo výrobku
-----------	-------	-------	---------------

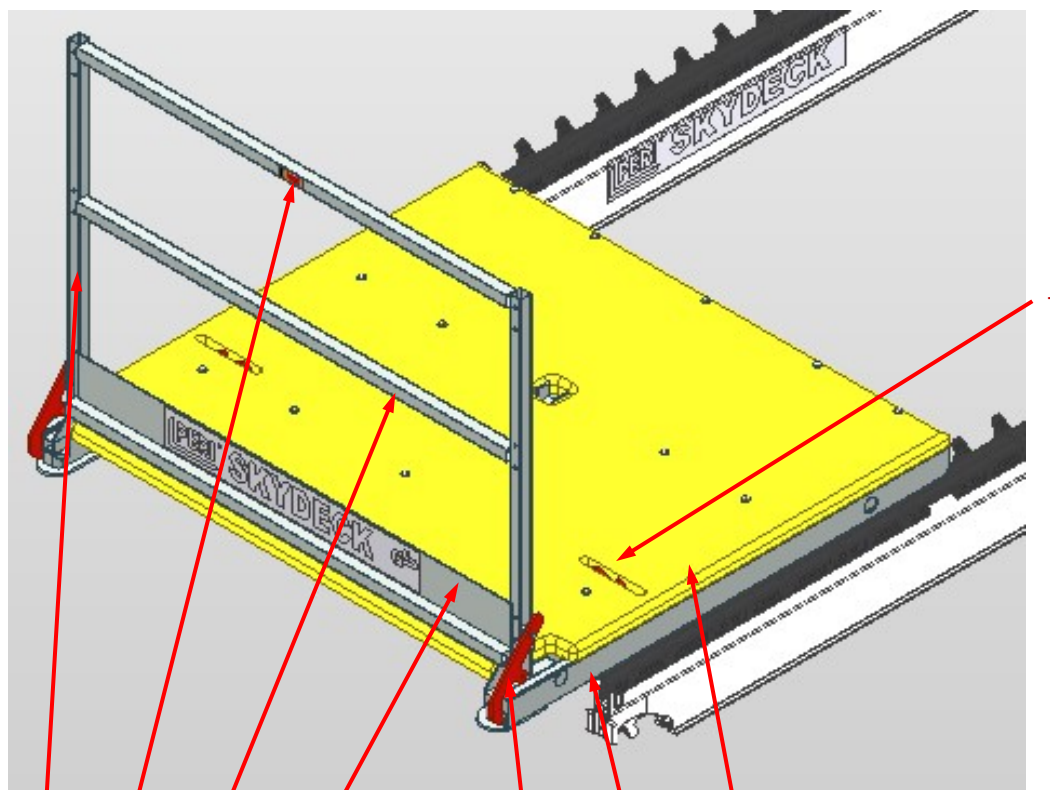

3 2 4 5 8 1 6

















1	Rám lávky SDB	
2	Zábradlí SDB	
3	Sloupek	
4	Vodorovná trubka	
5	Okopový plech	
6	Podlaha SDB	
7	Jeřábové oko	700703
8	Pojistka zábradlí	700667 700666

Valid for:

Lávka SDB 150	061060
Lávka SDB 225	061061
Lávka SDB 300	061062











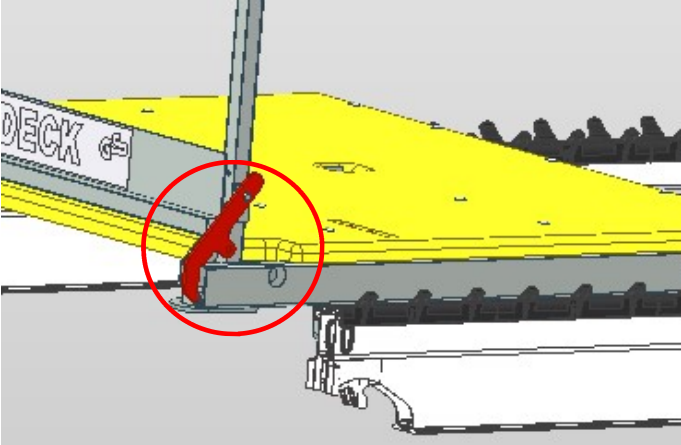

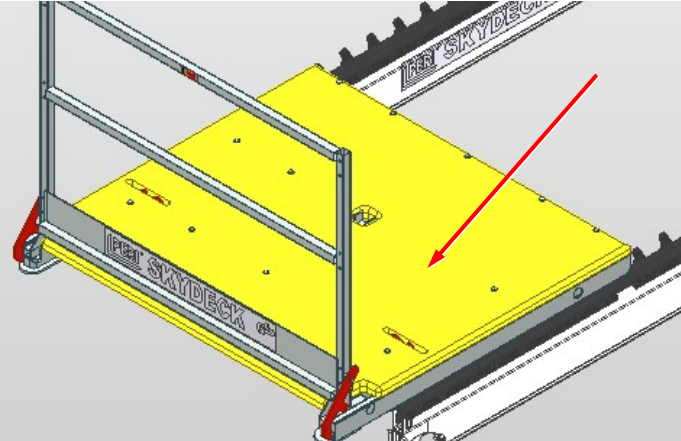

PERI Nájemní kritéria SKYDECK



Lávka SDB	Popis	Instrukce	Fakturace	Typ
	Ohnutý rám <ul style="list-style-type: none"> ■ Lze li srovnat bez poškození svárů ■ Nelze srovnat 	 	 	 
	<ul style="list-style-type: none"> 061063 (SDB 150) 061064 (SDB 225) 061065 (SDB 300) 	<ul style="list-style-type: none"> 700663 (Frame SDB 150) 700689 (Frame SDB 225) 700691 (Frame SDB 300) 	 	<ul style="list-style-type: none"> 088322 (150) 088323 (225) 088324 (300)
	Ohnuté zábradlí <ul style="list-style-type: none"> ■ Ohnutý sloupek ■ Ohnutá vodorovná trubka 	 	 	 
	<ul style="list-style-type: none"> 061063 (SDB 150) 061064 (SDB 225) 061065 (SDB 300) 	<ul style="list-style-type: none"> 061063 (SDB 150) 061064 (SDB 225) 061065 (SDB 300) 	<ul style="list-style-type: none"> 088322 (150) 088323 (225) 088324 (300) 	<ul style="list-style-type: none"> 088322 (150) 088323 (225) 088324 (300)

PERI Nájemní kritéria SKYDECK



Lávka SDB	Popis	Instrukce	Fakturace	Typ
	Ohnutá chybějící pojistka zábradlí	 700667 700666	 088320	
	Podlaha	<ul style="list-style-type: none">  061066 (SDB 150) 061067 (SDB 225) 061068 (SDB 300)  061066 (SDB 150) 061067 (SDB 225) 061068 (SDB 300)  061066 (SDB 150) 061067 (SDB 225) 061068 (SDB 300) 	<ul style="list-style-type: none">   088325 088326 088327  	<ul style="list-style-type: none">   

PERI Nájemní kritéria SKYDECK



Lávka SDB	Popis	Instrukce	Fakturace	Typ
-----------	-------	-----------	-----------	-----

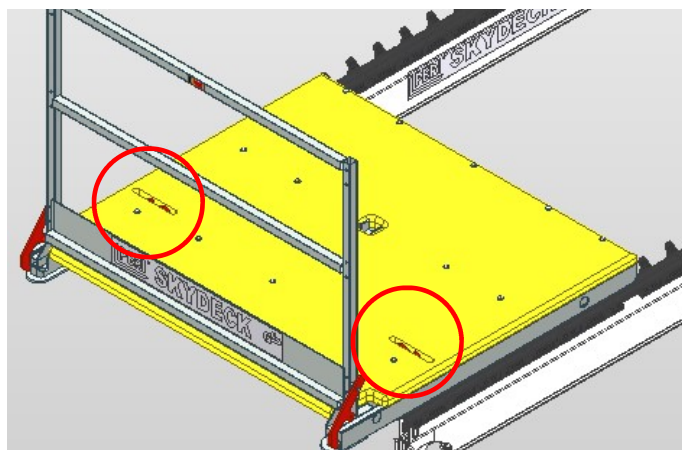







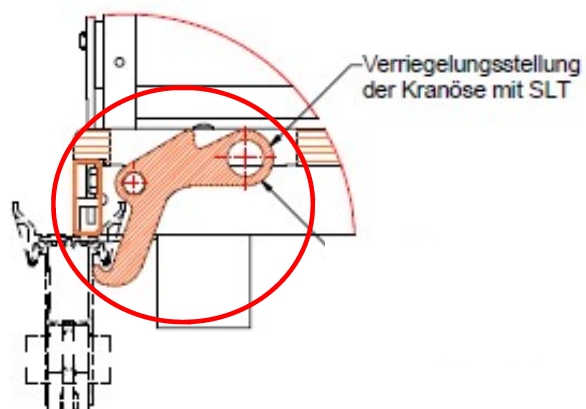





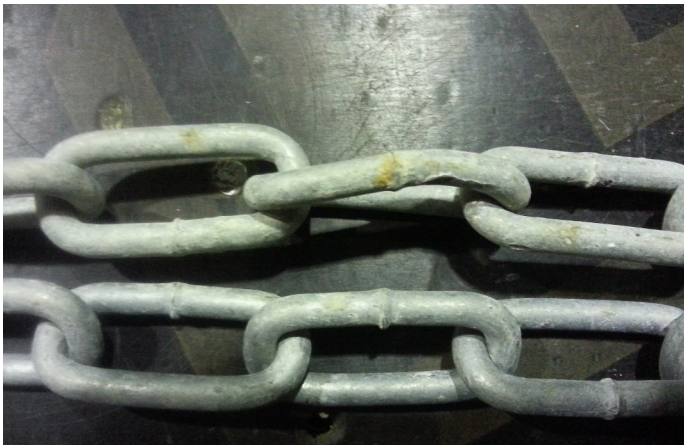

Ohnuté | chybějící jeřábové oko



700703



Napínací řetěz 3,0KN (065073)	Popis	Instrukce	Fakturace	Typ
	<p>Prasklina v řetězu</p>			
	<p>Ohnutá část řetězu</p>			
	<ul style="list-style-type: none"> ■ Bez prasklin v řetězu 			
	<ul style="list-style-type: none"> ■ Praskliny v řetězu 			

PERI Nájemní kritéria

SKYDECK



Napínací řetěz 3,0KN (065073)	Popis	Instrukce	Fakturace	Typ
-------------------------------	-------	-----------	-----------	-----



Zrezivělý řetěz

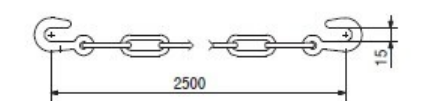







Není původní délka (Nominální délka 250 cm)

■ < 247,5 cm



■ > 257,0 cm



Napínací řetěz 3,0KN (065073)	Popis	Instrukce	Fakturace	Typ
 <p>Nominální rozměr 15 mm</p>	<p>Ohnutý hák</p> <ul style="list-style-type: none"> ■ < 13.5 mm ■ > 16.5 mm 	<ul style="list-style-type: none">   	<ul style="list-style-type: none">   	<ul style="list-style-type: none">  

Napínací očko SAO (061310)	Popis	Instrukce	Fakturace	Typ
----------------------------	-------	-----------	-----------	-----

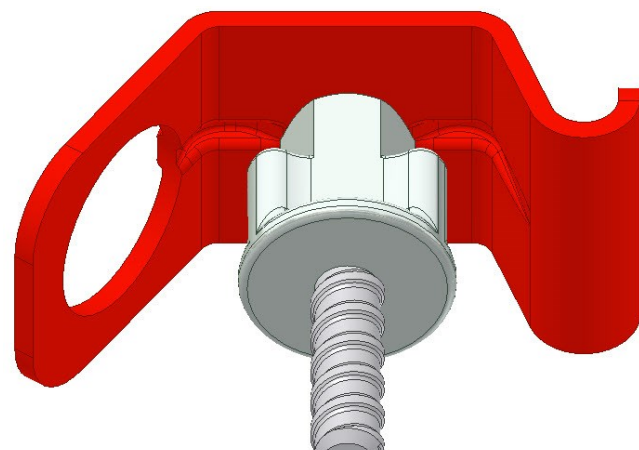

Ohnutý držák

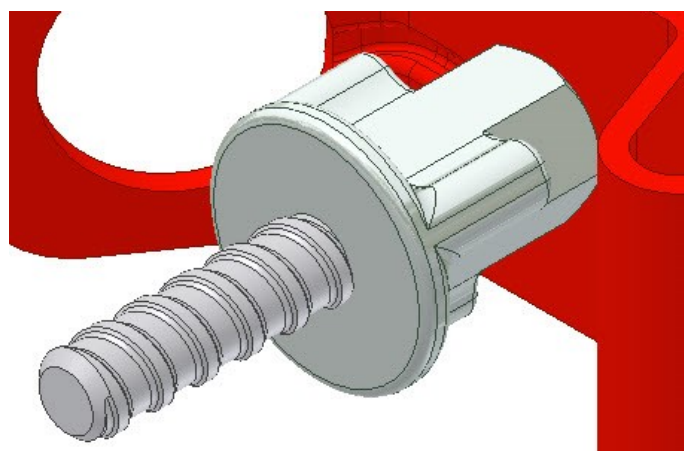

matice | Šroub chybí



030130 (Matice)
780128 (Šroub)



















089240
088025



PERI Nájemní kritéria

Vysvětlivky značek



Znak	Význam	Znak	Význam	Znak	Význam
	Není v pořádku – materiál je poškozený		Fakturuje se zákazníkovi		Optické poškození
	OK – materiál zůstává v nájemním skladu		Nefakturuje se zákazníkovi		Funkční poškození
	Poškozený materiál – není dovoleno vydávat materiál z bezpečnostních důvodů		Zkrácení prvku		Funkční poškození — není dovoleno vydávat materiál z bezpečnostních důvodů
	Oprava dle instrukcí		Označení prvku barvou		Statické poškození — není dovoleno vydávat materiál z bezpečnostních důvodů
	Oprava za studena — poté kontrola svárů a sousedních dílů		Výměna poškozeného dílu		
	Oprava po výpočtu hospodárnosti		Doplnění chybějícího dílu		
	Očištění materiálu				