

PERI Nájemní kritéria

Stropní stojky



Kontakt

PERI, spol. s r.o.
bednění řešení služby

Průmyslová 392
252 42 Jesenice u Prahy
tel.: 222 359 311
info@peri.cz
www.peri.cz

Obsah	Strana	Poslední změny	Datum Iniciály	Strana
PEP Ergo	2	Nová verze	09/2015 fw	
PEP 20, 30	7			
Příslušenství	11			
Vysvětlivky znaků	23			

PERI Nájemní kritéria

Stropní stojky



PEP ERGO	Č.	Popis	Číslo výrobku
----------	----	-------	---------------

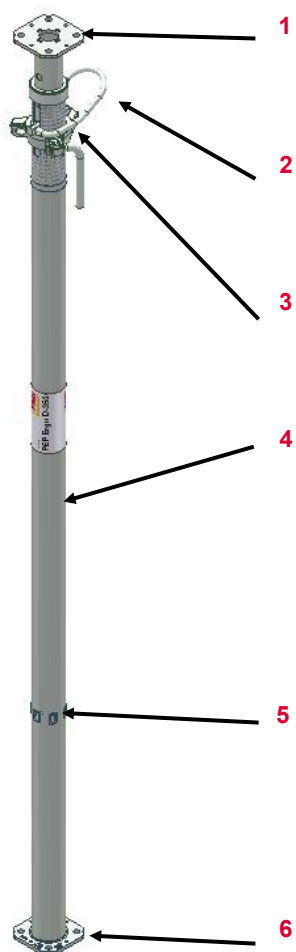











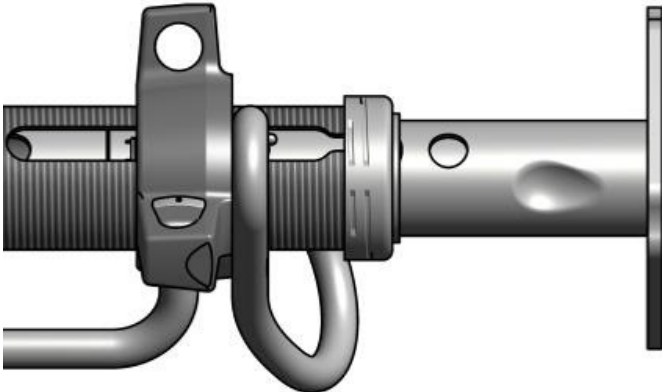

1	Hlavová deska
2	G – hák
3	Stavěcí matice
4	Vnější trubka
5	Prolis
6	Základní deska

Platný pro	Číslo výrobku
Stropní stojka PEP ERGO B-300	116780
Stropní stojka PEP ERGO B-350	116790
Stropní stojka PEP ERGO D-150	117230
Stropní stojka PEP ERGO D-250	116770
Stropní stojka PEP ERGO D-350	125130
Stropní stojka PEP ERGO D-400	125140
Stropní stojka PEP ERGO D-500	125150
Stropní stojka PEP ERGO E-300	125160
Stropní stojka PEP ERGO E-400	125170

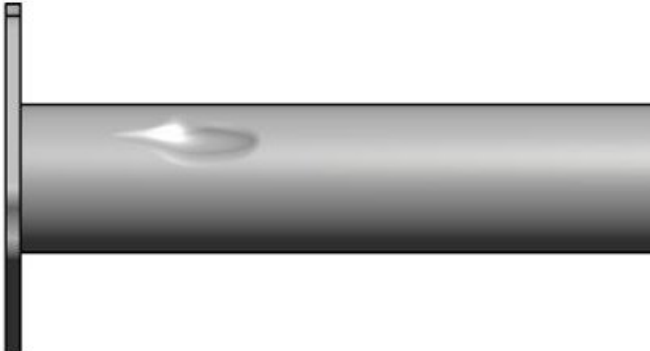
PERI Nájemní kritéria

Stropní stojky



PEP ERGO	Popis	Instrukce	Fakturace	Typ
	20.07.01 Promáčknutí/prohnutí na vnitřní trubce			
	<ul style="list-style-type: none"> ■ pokud není trubka pohyblivá 		 Tabulka (str. 4)	
	<ul style="list-style-type: none"> ■ hloubka promáčknutí > 7 mm 		 Tabulka (str. 4)	
	20.07.02 Promáčknutí/ prohnutí na vnější trubce			
	<ul style="list-style-type: none"> ■ pokud není trubka pohyblivá 		 Tabulka (str. 4)	
	<ul style="list-style-type: none"> ■ hloubka promáčknutí > 7 mm 		 Tabulka (str. 4)	

PERI Nájemní kritéria

Stropní stojky



Výrobek	Výměna vnitřní trubky		Výměna vnější trubky	
	Náhradní díl	Číslo servisního artiklu	Náhradní díl	Číslo servisního artiklu
PEP ERGO B-300	116786	088719	116788	088710
PEP ERGO B-350	116794	088720	116769	088711
PEP ERGO D-150	117226	088721	117228	088712
PEP ERGO D-250	116778	088722	116789	088713
PEP ERGO D-350	125543	088723	125546	088714
PEP ERGO D-400	125562	088724	125565	088715
PEP ERGO D-500	125581	088725	125584	088716
PEP ERGO E-300	125588	088726	125591	088717
PEP ERGO E-400	125595	088727	125598	088718

PERI Nájemní kritéria

Stropní stojky



















PEP ERGO	Popis	Instrukce	Fakturace	Typ
	20.07.03 Ohnutá hlavová nebo základní deska <ul style="list-style-type: none"> ■ > 10 mm 		088249	
	20.07.04 Stavěcí matice <ul style="list-style-type: none"> ■ odtržená část 		088235	
	<ul style="list-style-type: none"> ■ prasklina 		088235	
	20.07.05 G – hák <ul style="list-style-type: none"> ■ chybí 		088247	
	<ul style="list-style-type: none"> ■ nefunkční 		088247	

PERI Nájemní kritéria

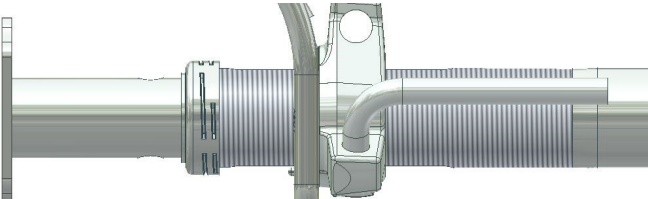
Stropní stojky











PEP ERGO	Popis	Instrukce	Fakturace	Typ
	20.07.06 Prasklina ve sváru			
	20.07.07 Pojistka proti vyšroubování chybí			
	20.07.08 Svařovaná/nahřátá trubka			
	20.07.09 Olej nebo mazivo v závitu			

PERI Nájemní kritéria

Stropní stojky



Pep Ergo	Popis	Instrukce	Fakturace	Typ
	Uříznutá základní nebo hlavová deska	 Výměna vnitřní nebo vnější trubky		
	Deformovaná díra ve vnitřní trubce	 Výměna vnitřní trubky		

PERI Nájemní kritéria

Stropní stojky



PEP 20, 30	Č.	Popis	Číslo výrobku
------------	----	-------	---------------

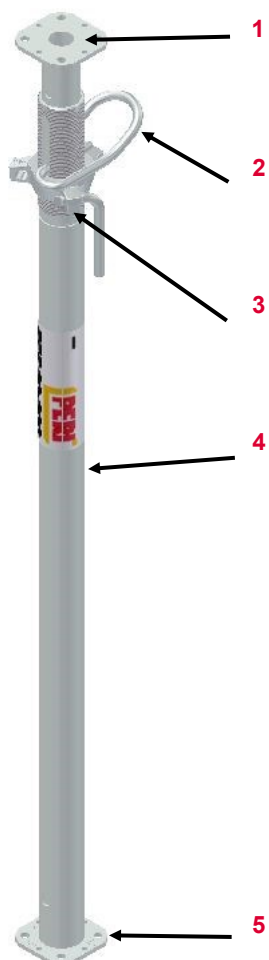











1	Hlavová deksa
2	G – hák
3	Stavěcí matice
4	Vnější trubka
5	Základní deska

Platný pro	Číslo výrobku
Stropní stojka PEP 20-300	103058
Stropní stojka PEP 20-350	103059
Stropní stojka PEP 20-400	103060
Stropní stojka PEP 20-500	103061
Stropní stojka PEP 30-150	103066
Stropní stojka PEP 30-250	103067
Stropní stojka PEP 30-300	103062
Stropní stojka PEP 30-350	103063
Stropní stojka PEP 30-400	103065

PERI Nájemní kritéria

Stropní stojky

















PEP 20, 30	Popis	Instrukce	Fakturace	Typ
	<p>20.07.10 Promáčknutí/prohnutí na vnitřní trubce</p> <ul style="list-style-type: none"> ■ pokud není trubka pohyblivá 			
	<p>20.07.11 Promáčknutí/ prohnutí na vnější trubce, vnitřní trubka není pohyblivá</p> <ul style="list-style-type: none"> ■ délka od základní desky ≤ 50 cm ■ délka od základní desky > 50 cm 	 WI_20_PEP_Dent_PropFIX_1930_en	 088249	
				

PERI Nájemní kritéria

Stropní stojky



PEP 20, 30	Popis	Instrukce	Fakturace	Typ
	<p>Ohnutá hlavová nebo základní deska</p> <ul style="list-style-type: none"> ■ > 10 mm 		 088249	
	<p>Stavěcí matice</p> <ul style="list-style-type: none"> ■ odtržená část ■ prasklina 			
	<p>G – hák</p> <ul style="list-style-type: none"> ■ chybí ■ nefunkční 		 088247	
			 088247	

PERI Nájemní kritéria

Stropní stojky



PEP 20, 30	Popis	Instrukce	Fakturace	Typ
	20.07.15 Prasklina ve sváru	 		
	20.07.16 Svařovaná/nahřátá trubka	 		
	20.07.17 Olej nebo mazivo v závitu			

PERI Nájemní kritéria

Stropní stojky



PEP 20-30	Popis	Instrukce	Fakturace	Typ
-----------	-------	-----------	-----------	-----



Uříznutá základní nebo hlavová deska















Neplatí pro PEP Ergo !



PERI Nájemní kritéria

Stropní stojky



Trojnožka PEP Ergo (107152)	Popis	Instrukce	Fakturace	Typ
	<p>20.07.18 Ohnutý výložník</p> <ul style="list-style-type: none"> ■ ≤ 10 mm ■ > 10 mm 	<ul style="list-style-type: none">   	<ul style="list-style-type: none">  088244  	<ul style="list-style-type: none">  
	 <p>Stanovená vzdálenost 70mm</p>	<p>20.07.19 Ohnuté upínací držadlo</p> <ul style="list-style-type: none"> ■ ≤ 3 mm ohnutí ■ > 3 mm ohnutí 	<ul style="list-style-type: none">   	<ul style="list-style-type: none">   088244

PERI Nájemní kritéria

Stropní stojky



Univerzální trojnožka (028000)

Č. Popis Číslo výrobku

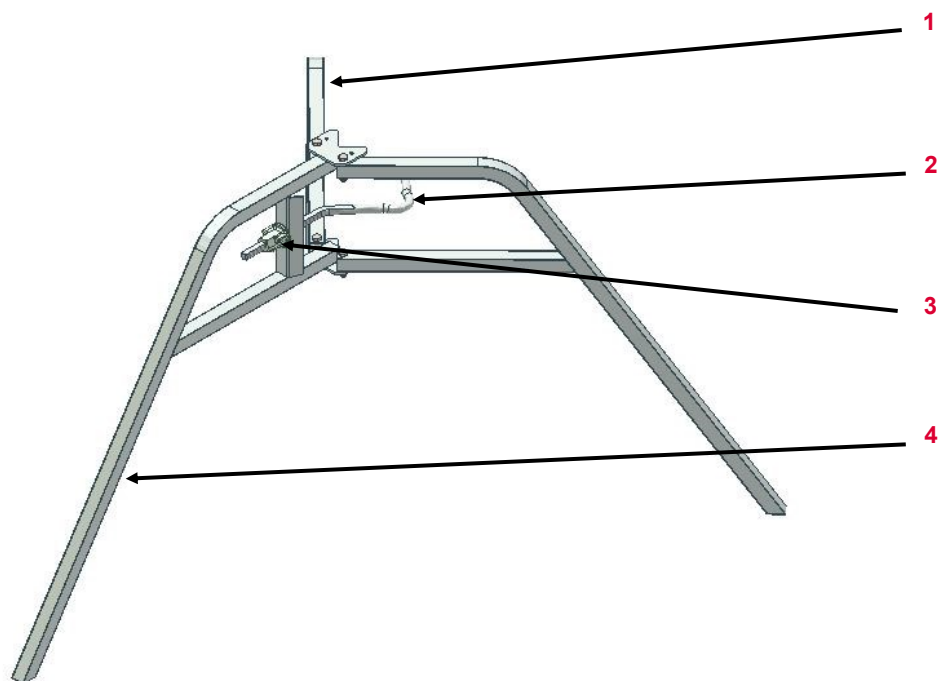













1	Otočný výložník	715643
2	Upínací držadlo	710161
3	Palcová matice	030130
4	Pevný výložník	715642

PERI Nájemní kritéria

Stropní stojky











Univerzální trojnožka	Popis	Instrukce	Fakturace	Typ
	<p>20.07.20 Ohnutý otočný výložník</p> <ul style="list-style-type: none"> ■ je možné narovnat ■ není možné narovnění 	<p> </p>	<p> 088244 </p>	<p> </p>
	<p>20.07.21 Ohnutý pevný výložník</p> <ul style="list-style-type: none"> ■ je možné narovnat ■ není možné narovnění 	<p>  </p>	<p> 088244 </p>	<p> </p>

PERI Nájemní kritéria

Stropní stojky











Univerzální trojnožka	Popis	Instrukce	Fakturace	Typ
	Ohnuté upínací držadlo ■ > 100°			
	Poškozená palcová matice	 030130 (Matice) 767043	 088429	

PERI Nájemní kritéria

Stropní stojky



Univerzální trojnožka	Popis	Instrukce	Fakturace	Typ
	Crack in welding			
	<ul style="list-style-type: none"> ■ Without damage of bordering parts 			
	Crack in tension hoop			
				

PERI Nájemní kritéria

Stropní stojky



Rám PRK	Č.	Popis	Číslo výrobku
---------	----	-------	---------------

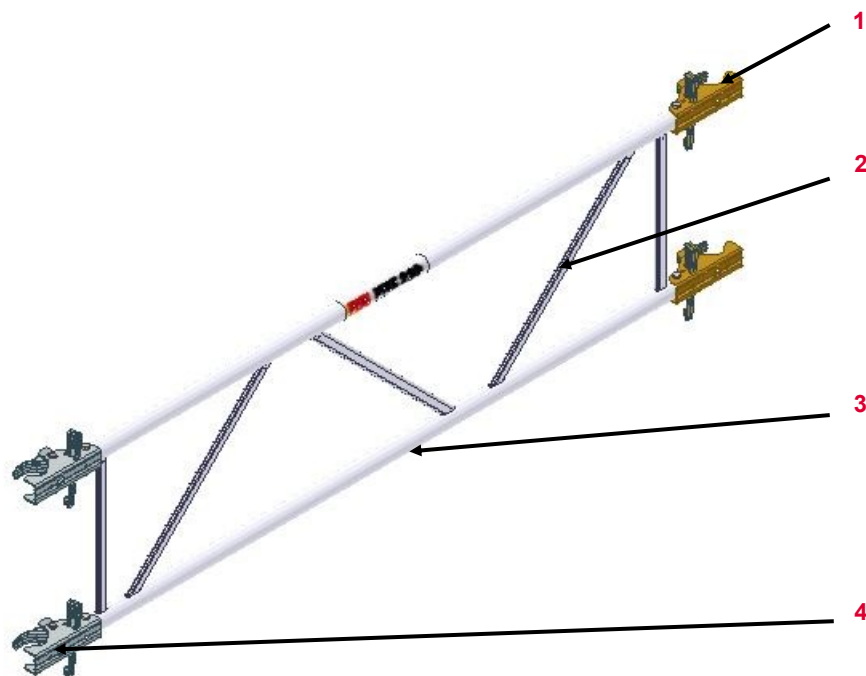

1	Úchyt PRK levý	112210
2	Výztuha	
3	Rám	
4	Úchyt PRK pravý	112206

Platný pro	Číslo výrobku
Rám PRK 62,5	111811
Rám PRK 75	111812
Rám PRK 100	112813
Rám PRK 120	112814
Rám PRK 137,5	111815
Rám PRK 150	111814
Rám PRK 180	115980
Rám PRK 200	112718
Rám PRK 201,5	111815
Rám PRK 210	112788
Rám PRK 225	111816
Rám PRK 230	111817
Rám PRK 266	111818
Rám PRK 296	111819

PERI Nájemní kritéria

Stropní stojky



Rám PRK	Popis	Instrukce	Fakturace	Typ
---------	-------	-----------	-----------	-----

20.07.24 Ohnutý rám



■ ≤ povolená deformace



■ > povolená deformace











Výrobek	Pov. ohnutí
PRK 62,5	2,5 mm
PRK 75	3,0 mm
PRK 100	4,0 mm
PRK 120	4,8 mm
PRK 137,5	5,5 mm
PRK 150	6,0 mm
PRK 180	7,2 mm
PRK 200	8,0 mm
PRK 201,5	8,0 mm
PRK 210	8,4 mm
PRK 225	9,0 mm
PRK 230	9,2 mm
PRK 266	10,5 mm
PRK 296	11,8 mm

PERI Nájemní kritéria

Stropní stojky



Rám PRK	Popis	Instrukce	Fakturace	Typ
	20.07.25 Nefunkční úchyt	 112210 (Úchyt levý) 112206 (Úchyt pravý)	 088246	
	20.07.26 Prasklina ve sváru	 		

PERI Nájemní kritéria

Stropní stojky





















Patka MP 50 (027310)	Popis	Instrukce	Fakturace	Typ
	20.07.27 Důlky na trubce			
	■ ≤ 6 mm hloubka ≤ Ø 60 mm			
	■ > 6 mm hloubka			
	■ > Ø 60 mm			
<p data-bbox="539 1334 763 1420">Bez dovolených deformací v oblasti trubky</p>	20.07.28 Ohnutá hlava nebo patka			
	■ ≤ 15 mm			088244
	■ > 15 mm			

PERI Nájemní kritéria

Stropní stojky



Patka MP 50 (027310)	Popis	Instrukce	Fakturace	Typ
	20.07.29 Pružná trubka vadná, chybí			
	<ul style="list-style-type: none"> ■ pružná trubka 1. verze (černá) 			
	20.07.30 Napínací chapadlo (upínka) poškozené, chybí			
	<ul style="list-style-type: none"> 780108 (pružná trubka) 780105 (napínací chapadlo) 710381 (matice) 780702 (podložka 2x) 	088367		
	20.07.31 Napínací chapadlo (upínka) neutažená			
<ul style="list-style-type: none"> ■ matici utáhněte tak, aby ručně bylo možné upínkou pohnout jen stěží 				

PERI Nájemní kritéria

Stropní stojky



Křížová hlava 20/24 (027890)	Popis	Instrukce	Fakturace	Typ
	20.07.32 Ohnuté vidlice		088395	
	<ul style="list-style-type: none"> ■ bez poškození svárů 		088394	
	<ul style="list-style-type: none"> ■ poškozené sváry 		088394	
<ul style="list-style-type: none"> ■ chybějící 		088394		
	20.07.33 Ohnutá základní deska			
<ul style="list-style-type: none"> ■ > 5 mm 				

PERI Nájemní kritéria

Stropní stojky



Křížová hlava 20/24 S (027890 028680)	Popis	Instrukce	Fakturace	Typ
---	-------	-----------	-----------	-----













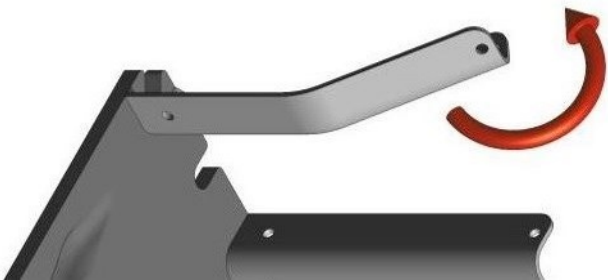







Svařované držadlo (Nestandardní svařování)

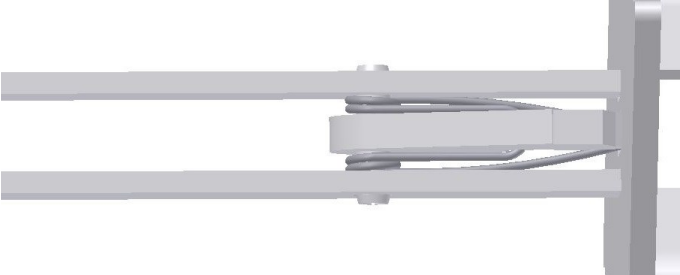

PERI Nájemní kritéria

Stropní stojky



Křížová hlava 20/24S (028680)	Popis	Instrukce	Fakturace	Typ
	<p>20.07.34 Ohnuté vidlice</p> <ul style="list-style-type: none"> ■ Bez poškození svárů ■ Poškozené sváry ■ Chybějící 	  	 088395  088394  088394	  
	<p>20.07.35 Ohnutá základní deska</p> <ul style="list-style-type: none"> ■ > 5 mm 	 		
	<p>20.07.36 Klapka</p>		 088898	

PERI Nájemní kritéria

Stropní stojky



Spona pro zavětrování stojek (027940; 027790)	Č.	Popis	Číslo výrobku
---	----	-------	---------------

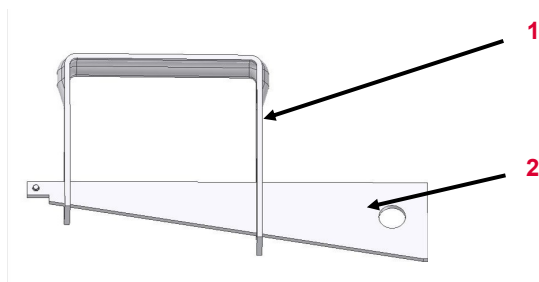

- | | |
|---|-------|
| 1 | Držák |
| 2 | Klín |

Poškození	Popis	Instrukce	Fakturace	Typ
-----------	-------	-----------	-----------	-----

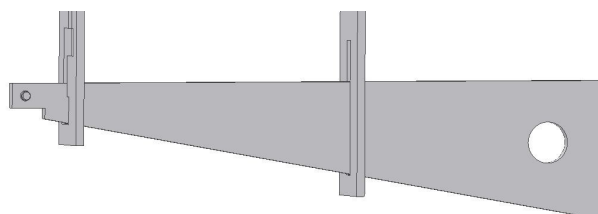

20.07.37 Chybějící klín

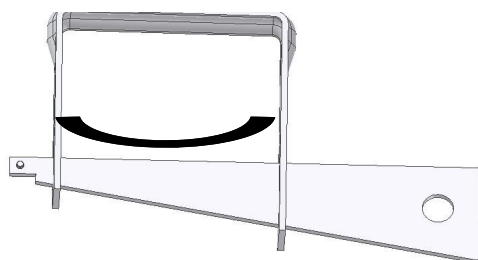

20.07.38 Ohnutý držák



088244



PERI Nájemní kritéria

Vysvětlivky znaků



Znak	Význam	Znak	Význam	Znak	Význam
	Není v pořádku – materiál je poškozený		Fakturuje se zákazníkovi		Optické poškození
	OK – materiál zůstává v nájemním skladu		Nefakturuje se zákazníkovi		Funkční poškození
	Poškozený materiál – není dovoleno vydávat materiál z bezpečnostních důvodů		Zkrácení prvku		Funkční poškození — není dovoleno vydávat materiál z bezpečnostních důvodů
	Oprava dle instrukcí		Označení prvku barvou		Statické poškození — není dovoleno vydávat materiál z bezpečnostních důvodů
	Oprava za studena — poté kontrola svárů a sousedních dílů		Výměna poškozeného dílu		
	Oprava po výpočtu hospodárnosti		Doplnění chybějícího dílu		
	Očištění materiálu				