

PERI Nájemní kritéria

TRIO

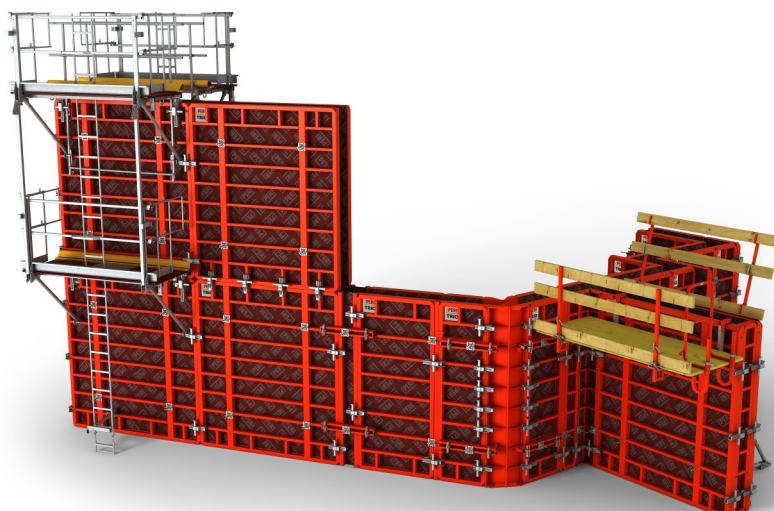

Kontakt

PERI, spol. s r.o.
bednění lešení služby

Průmyslová 392
252 42 Jesenice u Prahy
tel.: 222 359 311
info@peri.cz
www.peri.cz

Obsah	Strana	Poslední změny	Datum Iniciály	Strana
TRIO ocelový rám	2	Nová verze	09/2015 fw	
TRIO hliníkový rám	14	Přidáno poškození Závor TAR	19/2019 fw	50
TRIO kloubový roh	21	Poškození TSE přidáno	04/2020 fw	38
Roh TRIO	24	Přidáno poškození hřebíky	03/2022 fw	11
Vložka WDA	26	Nová kritéria pro HSGP-2	03/2022 fw	55
Betonářská lávka TRIO	34	Přidána konzola TRG	03/2022 fw	42
Šachtový díl	38			
Příslušenství	41			
Vysvětlivky znaků	57			

PERI Nájemní kritéria

TRIO



TRIO rám ocelový

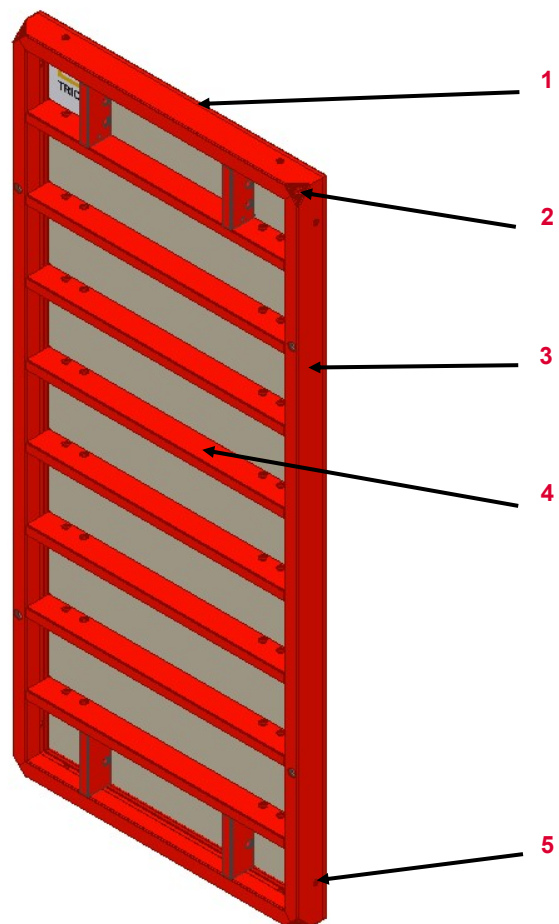

Č.	Popis	Číslo výrobku
1	Čelní profil	
2	Odbedňovací roh	750580
3	Podélný profil	
4	Žebro	
5	Lemovací vložka	750127













PERI Nájemní kritéria















TRIO

















Výrobek	Číslo výrobku
Panel TR/4 330x240	054304
Panel TR/4 330x120	054314
Panel TR/4 330x90	054324
Panel TR/4 330x72	054334
Panel TR/4 330x60	054354
Panel TR/4 330x30	054364
Víceúčelový panel TRM/4 330x72	054344
Doplňkový panel TR/4 330x24	023050
Panel TR 270x240	022570
Panel TR 270x120	022510
Panel TR 270x90	022520
Panel TR 270x72	022530
Panel TR 270x60	022550
Panel TR 270x30	022560
Víceúčelový panel TRM 270x 72	022540
Doplňkový panel TR 270x24	023040

Výrobek	Číslo výrobku
Panel TR 120x240	022514
Panel TR 120x120	022600
Panel TR 120x90	022610
Panel TR 120x72	022620
Panel TR 120x60	022640
Panel TR 120x30	022650
Víceúčelový panel TRM 120x72	022630
Doplňkový panel TR 120x24	023030
Panel TR 60x90	022790
Panel TR 60x72	022800
Panel TR 60x60	022810
Panel TR 60x30	022820

TRIO ocelový rám	Popis	Instrukce	Fakturace	Typ	
	<p>27.01 Vytržené části profilu a výztuhy</p>	 			
	<p>27.02 Deformace čelního profilu</p> <ul style="list-style-type: none"> ■ promáčknutí způsobené sestavovacím hákem ■ poškození způsobené hrubým zacházením 			<p>Tabulka (str. 11)</p>	
				<p>Tabulka (str. 11)</p>	

TRIO ocelový rám	Popis	Instrukce	Fakturace	Typ
	27.03 Deformovaný podélný profil			
	<ul style="list-style-type: none"> <li data-bbox="869 571 1294 635">■ promáčknutí způsobené sestavovacím hákem <li data-bbox="869 794 1294 858">■ poškození způsobené hrubým zacházením 			
	27.04 Díry v panelech			
	<ul style="list-style-type: none"> <li data-bbox="869 1074 1294 1106">■ ≤ Ø 3 cm 		 088028	
	<ul style="list-style-type: none"> <li data-bbox="869 1217 1294 1249">■ > Ø 3 cm v podélném profilu 			
<ul style="list-style-type: none"> <li data-bbox="869 1361 1294 1425">■ > Ø 3 cm v čelním profilu nebo žebru 		 Tabulka (str. 11+ 12)		

TRIO ocelový rám	Popis	Instrukce	Fakturace	Typ
	<p>27.05 Promáčknuté žebro</p>		 Tabulka (str. 12)	
	<p>27.06 Poškozená nebo vytrhnutá lemovací vložka v žebro</p> <ul style="list-style-type: none"> ■ pokud je možné narovnění ■ pokud není možné narovnění ■ vytrhnutá lemovací vložka 	<ul style="list-style-type: none">    	<ul style="list-style-type: none">  088244  Tabulka (str. 12)  Tabulka (str. 12) 	<ul style="list-style-type: none">   

TRIO ocelový rám	Popis	Instrukce	Fakturace	Typ
------------------	-------	-----------	-----------	-----

27.07 Diagonálně ohnutý panel

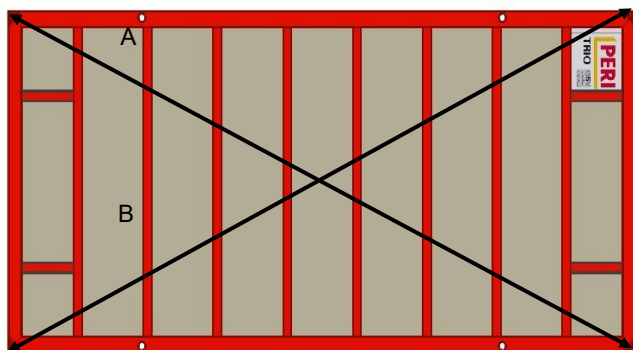











- rozdíl mezi A a B > 6 mm























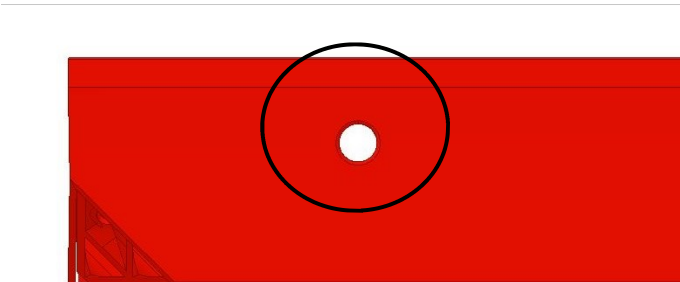

27.08 Ohnutý panel

- > 8 mm



TRIO ocelový rám	Popis	Instrukce	Fakturace	Typ	
	27.09 Vyboulený profil	<ul style="list-style-type: none"> ■ ≤ 5 mm hloubka 			
	<ul style="list-style-type: none"> ■ > 5 mm hloubka 			088027	
	27.10 Vyboulená hrana profilu	<ul style="list-style-type: none"> ■ > 3 mm a ≤ 10 mm 			
	<ul style="list-style-type: none"> ■ > 10 mm 		Vyměňte starou překližku a opravte hranu		088236

TRIO ocelový rám	Popis	Instrukce	Fakturace	Typ
	27.11 Prasklina ve sváru rohu		 088028	
	27.12 Prasklina ve sváru na hraně profilu		 088028	
	<ul style="list-style-type: none"> ■ pokud je ohnutý profil 		 088028	
	<ul style="list-style-type: none"> ■ pokud není ohnutý profil 			

TRIO ocelový rám	Popis	Instrukce	Fakturace	Typ	
	27.13 Deformovaný odbedňovací roh			088176	
	27.14 Poškozená nebo chybějící lemovací vložka			088002	
	27.15 Díry v rámu způsobené zrezivěním	<ul style="list-style-type: none"> ■ Test s 300 g kladivem 	 		

TRIO ocelový rám	Popis	Instrukce	Fakturace	Typ
	Díry po hřebících			
	<ul style="list-style-type: none"> ■ Jedna díra $\varnothing < 5$ mm 			
	<ul style="list-style-type: none"> ■ Více děr v těsné blízkosti 			
<ul style="list-style-type: none"> ■ Díra větší $> \varnothing 5$ mm 				

PERI Nájemní kritéria

TRIO



Výrobek	Čelní profil	
	Náhradní díl	Číslo servisního artiklu
Čelní profil 30	109106	088049
Čelní profil 60	109031	088051
Čelní profil 90	109023	088052
Čelní profil 120	109021	088053
Čelní profil 240	745051	088054
Čelní profil 270	745050	088055

PERI Nájemní kritéria

TRIO



Výrobek	Žebro	
	Náhradní díl	Číslo servisního artiklu
Žebro 18	745357	088038
Žebro 19	112479	088039
Žebro 22	745356	088040
Žebro 43	745355	088043
Žebro 48	745354	088044
Žebro 78	745352	088046
Žebro 122	745350	088047
Žebro 60	745353	088232
Žebro 23	745358	

PERI Nájemní kritéria

TRIO





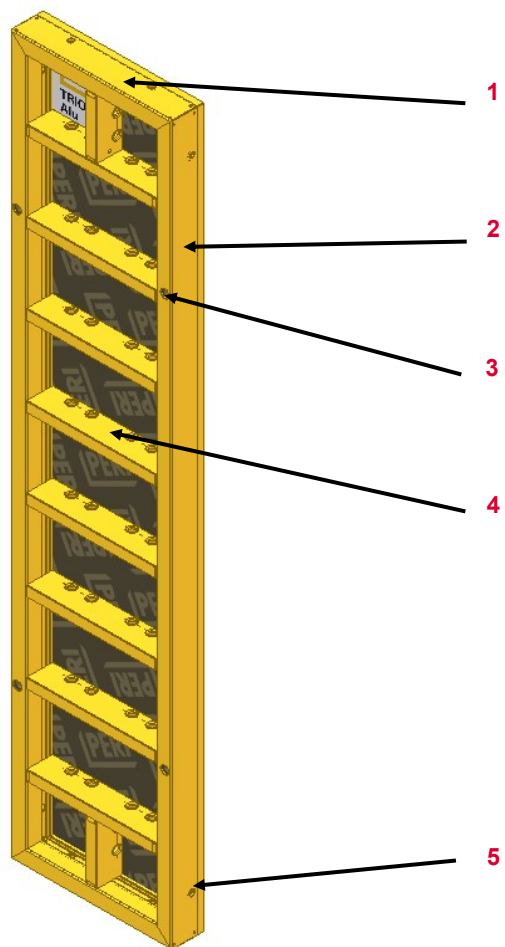







TRIO hliníkový rám



Č.	Popis	Číslo výrobku
1	Čelní profil	
2	Podélný profil	
3	Lemovací vložka 18	710160
4	Žebro	
5	Lemovací vložka 8	750120









Platné pro:	Číslo výrobku
Panel TRA 270x90	023850
Panel TRA 270x60	023870
Panel TRA 270x30	023880
Panel TRA 90x120	023900
Panel TRA 90x60	023950
Panel TRA 90x30	023960
Víceúčelový panel TAM 270x72	023860
Víceúčelový panel TAM 90x72	023980











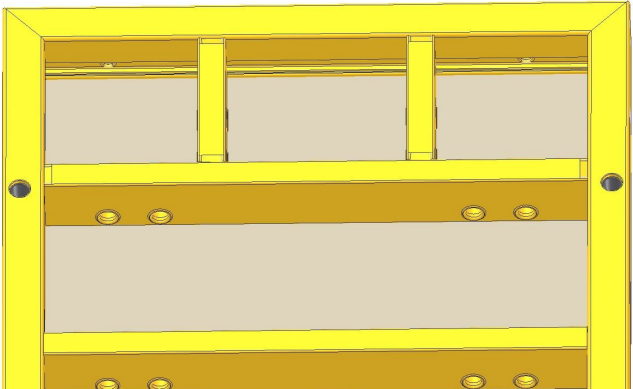



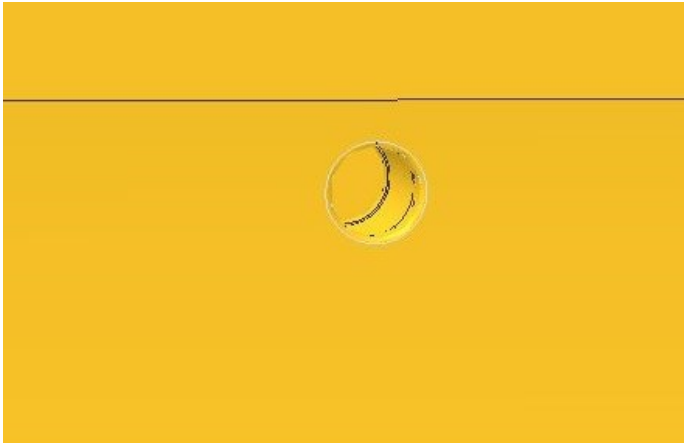

TRIO hliníkový rám	Popis	Instrukce	Fakturace	Typ
	27.16 Vytržené části profilu a výztuhy			
	27.17 Deformace čelního profilu <ul style="list-style-type: none"> ■ promáčknutí způsobené sestavovacím hákem ■ poškození způsobené hrubým zacházením 	 	 	 

PERI Nájemní kritéria

TRIO



TRIO ocelový rám	Popis	Instrukce	Fakturace	Typ
	27.18 Deformovaný podélný profil			
	<ul style="list-style-type: none"> ■ promáčknutí způsobené sestavovacím hákem ■ poškození způsobené hrubým zacházením 	 	 	 
	27.19 Díry v panelu			

TRIO hliníkový rám	Popis	Instrukce	Fakturace	Typ
	27.20 Promáčknuté žebro			
	27.21 Poškozená nebo vytrhnutá lemovací vložka v žebře			
	<ul style="list-style-type: none"> ■ pokud je možné narovnání 			
	<ul style="list-style-type: none"> ■ pokud není možné narovnání 			
	<ul style="list-style-type: none"> ■ vytrhnutá lemovací vložka 			
			088244	
			088002	
			088002	

TRIO hliníkový rám	Popis	Instrukce	Fakturace	Typ
--------------------	-------	-----------	-----------	-----

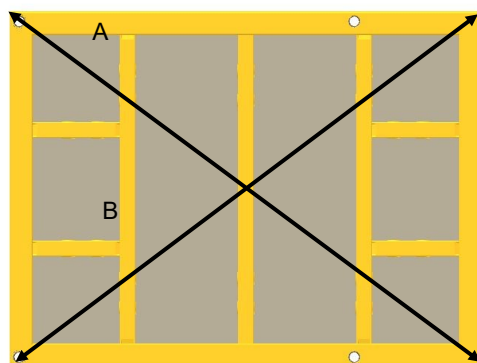

27.22 Diagonálně ohnutý panel



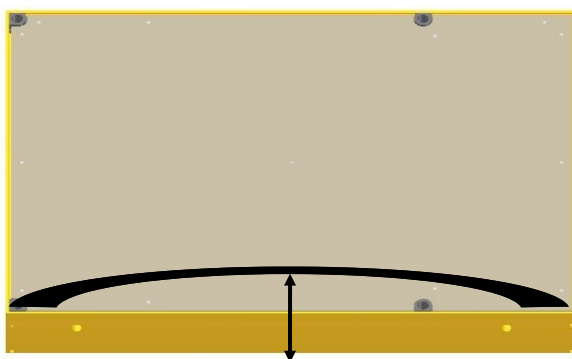













- rozdíl mezi A a B > 6 mm



27.23 Ohnutý panel

- > 8 mm











TRIO hliníkový rám	Popis	Instrukce	Fakturace	Typ
	27.24 Vyboulený profil	<ul style="list-style-type: none"> ■ ≤ 5 mm hloubka   		
	<ul style="list-style-type: none"> ■ > 5 mm hloubka 		 088027	
	27.25 Vyboulená hrana profilu	<ul style="list-style-type: none"> ■ ≤ 3 mm   		
	<ul style="list-style-type: none"> ■ > 3 mm a ≤ 10 mm 		 0882636	
	<ul style="list-style-type: none"> ■ > 10 mm 	 Vyměňte starou překližku a opravte hranu	 088236	

PERI Nájemní kritéria

TRIO



TRIO hliníkový rám	Popis	Instrukce	Fakturace	Typ
	27.26 Prasklina ve sváru rohu		 088243	
	27.27 Prasklina ve vnitřním sváru rohu		 088243	

PERI Nájemní kritéria

TRIO





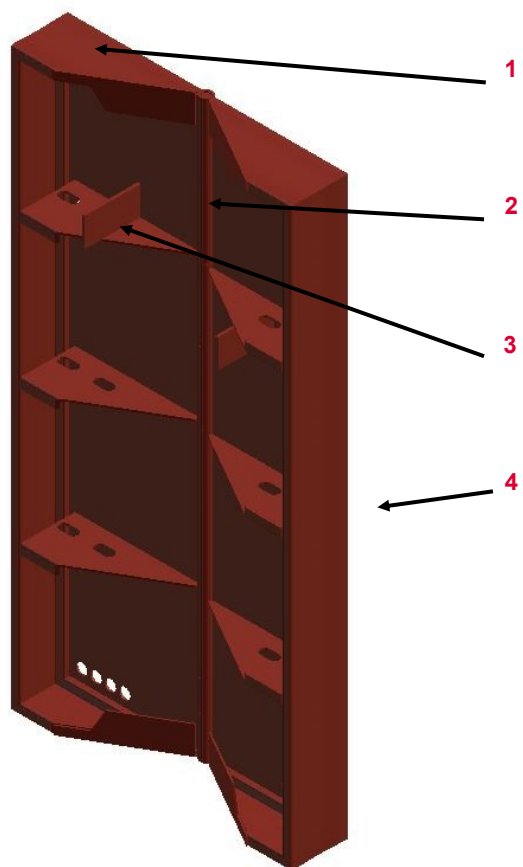









TRIO Kloubový roh TGE



Č.	Popis	Číslo výrobku
1	Čelní deska	722066
2	Kloub	
3	Ocelová deska	740211
4	Plocha k betonu	

Platné pro:	Číslo výrobku
Kloubový roh TGE/4 330	054414
Kloubový roh TGE 270	023200
Kloubový roh TGE 120	023300

TRIO Kloubový roh TGE	Popis	Instrukce	Fakturace	Typ
	<p>27.28 Promáčknutí nebo zlomení profilu nebo plochy k betonu</p> <ul style="list-style-type: none"> ■ ≤ 3 mm ■ > 3 mm a ≤ 10 mm ■ > 10 mm 	<ul style="list-style-type: none">     	<ul style="list-style-type: none">    	<ul style="list-style-type: none">   
	<p>27.29 Diagonálně ohnutý rám</p> <ul style="list-style-type: none"> ■ rozdíl mezi A and B > 5 mm 	<ul style="list-style-type: none">  	<ul style="list-style-type: none">  	<ul style="list-style-type: none"> 

TRIO Kloubový roh TGE

Popis

Instrukce

Fakturace

Typ

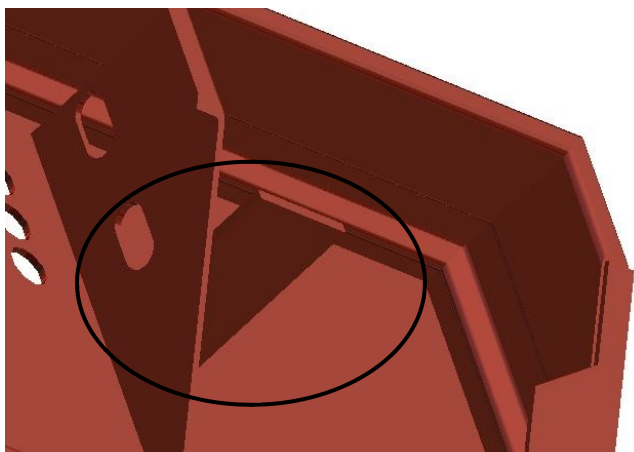

27.30 Ohnutá deska



088244

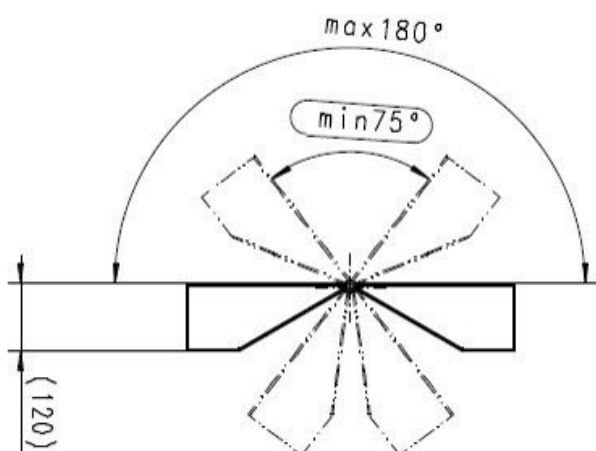

27.31 Funkce

■ roh lze zavřít obtížně



Poté panty nastříkejte olejem



■ roh nelze zavřít



■ Nefunkční roh po čištění a opravě



PERI Nájemní kritéria

TRIO





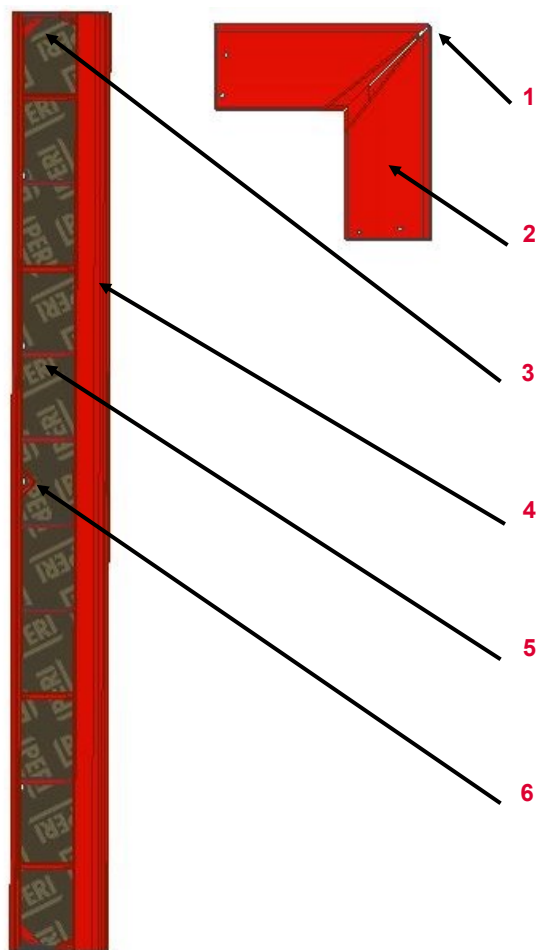



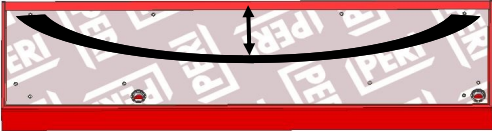

Roh TRIO	Č.	Popis	Číslo výrobku
----------	----	-------	---------------

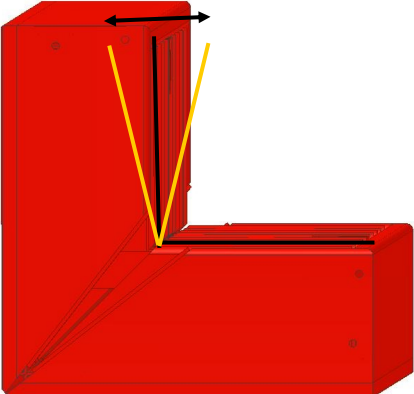

1	Čelo rohu	
2	Čelní profil	
3	Výztuha	740205
4	Podélný profil	
5	Žebro	
6	Opěra	721794

Platné pro:	Číslo výrobku
Roh TAE 270-2	023891
Roh TAE 90-2	023971
Roh TE 270-2	022580
Roh TE 120-2	022660
Roh TE 60-2	022840

Roh TRIO	Popis	Instrukce	Fakturace	Typ
	27.32 Ohnutý panel ■ > 8 mm			
	27.33 Ohnutý roh v úhlu ■ > 10 mm			

PERI Nájemní kritéria

TRIO











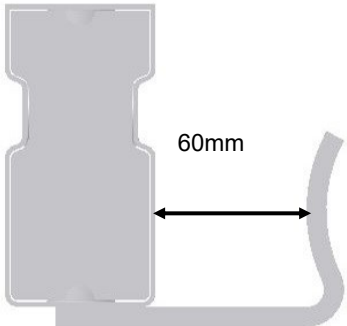

Vložka WDA	Č.	Popis	Číslo výrobku
------------	----	-------	---------------





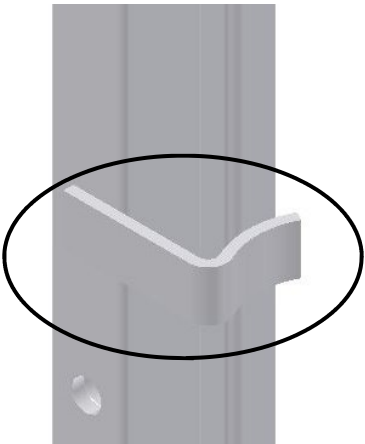



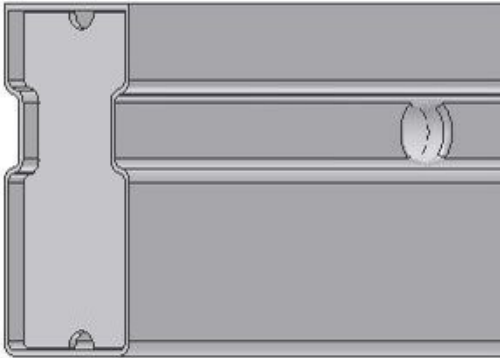

1	Čelní pech
2	Háček
3	Plocha k betonu
4	Lemovací vložka

Platné pro:	Číslo výrobku
Vložka WDA/4 330x6	054401
Vložka WDA/4 330x5	054391
Vložka WDA-2 270x6	023192
Vložka WDA-2 270x5	023182
Vložka WDA-2 120x6	023292
Vložka WDA-2 120x5	023282

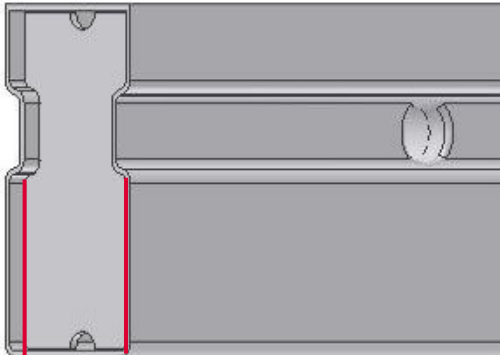
Vložka WDA	Popis	Instrukce	Fakturace	Typ
	<p>27.34 Ohnutá vložka</p> <ul style="list-style-type: none"> ■ > 8 mm 			
	<p>27.35 Promáčknutí v ploše k betonu</p> <ul style="list-style-type: none"> ■ ≤ 3 mm ■ > 3 mm a ≤ 10 mm ■ > 10 mm 	<ul style="list-style-type: none">    	<ul style="list-style-type: none">    	<ul style="list-style-type: none">   

Vložka WDA	Popis	Instrukce	Fakturace	Typ
	<p>27.36 Ohnutý háček</p> <ul style="list-style-type: none"> ■ ≤ 10 mm ■ > 10 mm 	<ul style="list-style-type: none">   	<ul style="list-style-type: none">  088244  088164 	<ul style="list-style-type: none">  
	<p>27.37 Chybějící háček</p>	<ul style="list-style-type: none">  	<ul style="list-style-type: none">  088164 	<ul style="list-style-type: none"> 

Vložka WDA	Popis	Instrukce	Fakturace	Typ
	<p>27.38 Deformovaný čelní plech (bez poškození sváru)</p>			
	<p>27.39 Deformovaný čelní plech (s poškozením sváru)</p>			

PERI Nájemní kritéria

TRIO





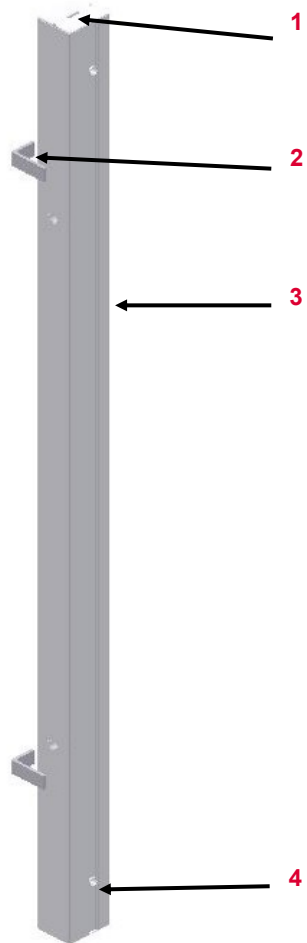





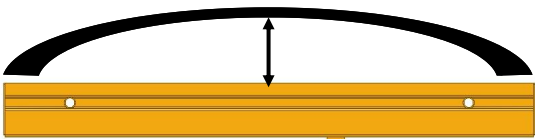



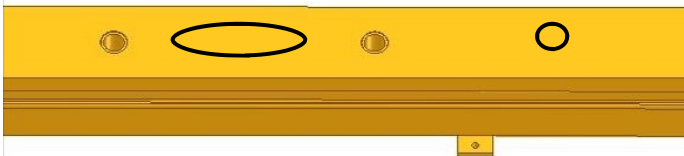









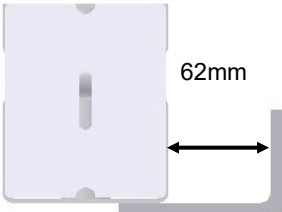

Vložka WDA alu.	Č.	Popis	Číslo výrobku
-----------------	----	-------	---------------



1	Čelní plech	101959
2	Háček	
3	Plocha k betonu	
4	Lemovací vložka	

Platné pro:	Číslo výrobku
Vložka WDA/4 330x10 Alu	054435
Vložka WDA 270x10 Alu	023995
Vložka WDA 120x10 Alu	023990









Vložka WDA alu.	Popis	Instrukce	Fakturace	Typ
	27.40 Ohnutá vložka	<ul style="list-style-type: none"> ■ > 8 mm  		
	27.41 Promáčknutí v ploše k betonu	<ul style="list-style-type: none"> ■ ≤ 3 mm   ■ > 3 mm a ≤ 10 mm  ■ > 10 mm  	<ul style="list-style-type: none">    	<ul style="list-style-type: none">   

Vložka WDA alu.	Popis	Instrukce	Fakturace	Typ
	<p>27.42 Ohnutý háček</p> <ul style="list-style-type: none"> ■ ≤ 10 mm ■ > 10 mm 	<ul style="list-style-type: none">  740781 (WDA 120) 740776 (WDA 270 + 330)  	<ul style="list-style-type: none">  088244  088000 	<ul style="list-style-type: none">  
	<p>27.43 Chybějící háček</p>	<ul style="list-style-type: none">  740781 (WDA 120) 740776 (WDA 270 + 330) 	<ul style="list-style-type: none">  088000 	<ul style="list-style-type: none"> 

PERI Nájemní kritéria

TRIO



Vložka WDA alu.	Popis	Instrukce	Fakturace	Typ
	27.44 Deformovaný čelní plech (bez poškození sváru)			
	27.45 Deformovaný čelní plech (s poškozením sváru)		 088001	

PERI Nájemní kritéria

TRIO



Betonářská lávka TRIO 120x270 (022950)

Č.	Popis	Číslo výrobku
----	-------	---------------

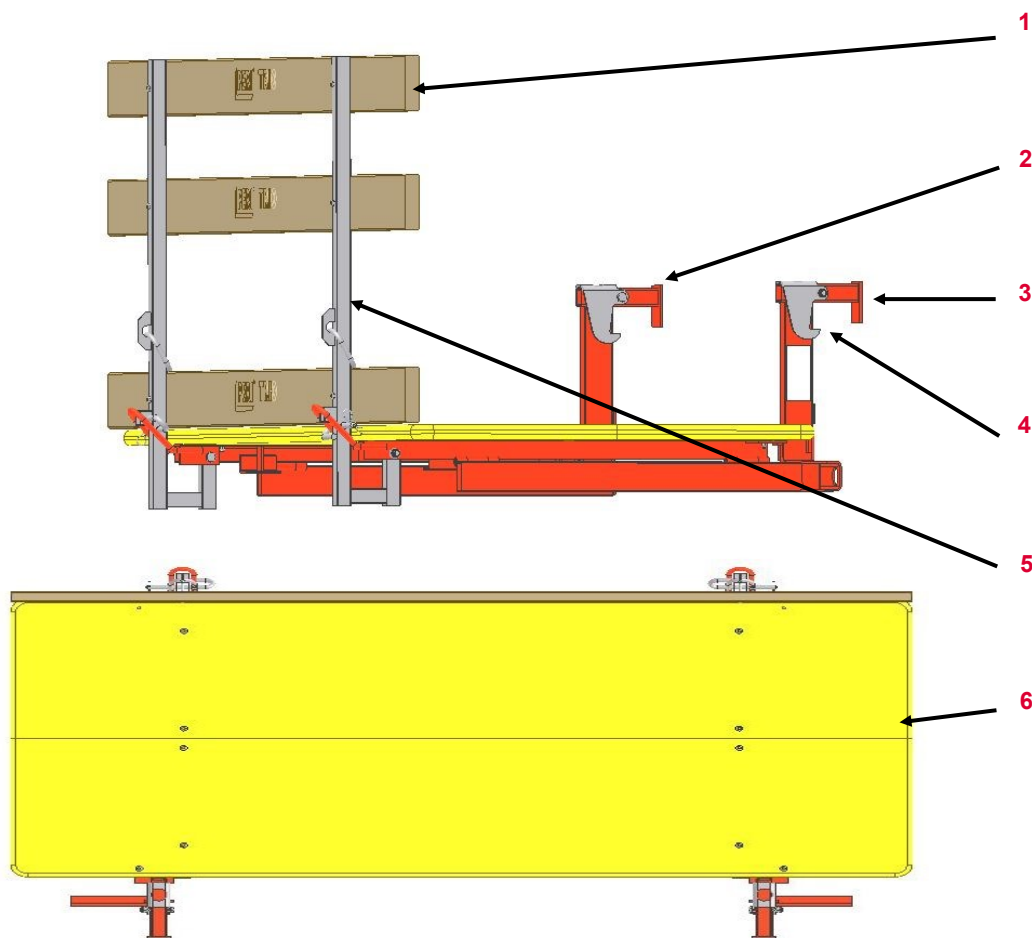













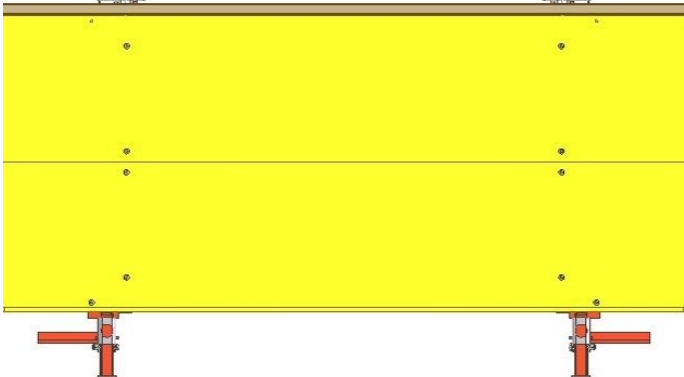



1	TRIO zábradlová fošna	022980
2	Betonářská konzola TBK	022970
3	Betonářská konzola TBK	022960
4	Jeřábové oko	721726
5	Sloupek	102623
6	Vrstvenná deska	022995









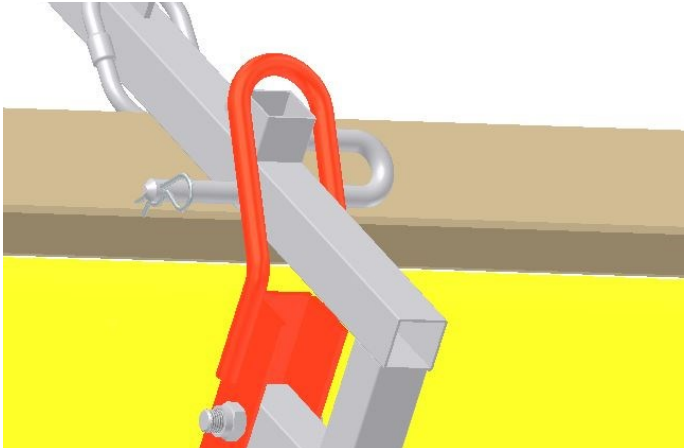

PERI Nájemní kritéria

TRIO

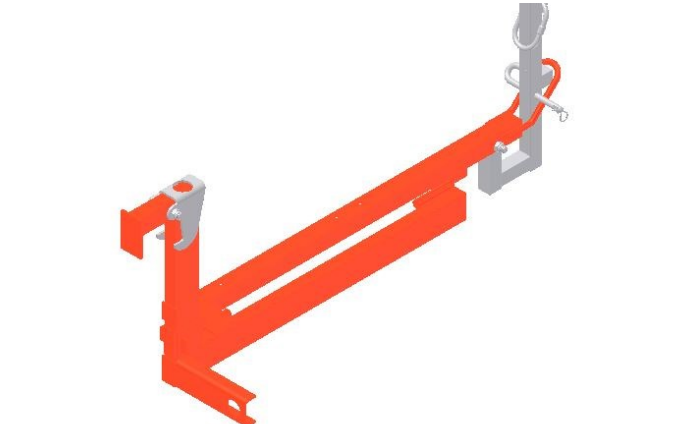

Betonářská lávka TRIO	Popis	Instrukce	Fakturace	Typ
	27.54 POškozená nebo chybějící zábradlová fošna	 022980	 088215	
	27.55 Opatřebovaná deska	 022995	 088214	

Betonářská lávka TRIO	Popis	Instrukce	Fakturace	Typ
	27.56 Poškozené jeřábové oko	 721726	 088219	
	27.57 Poškozený sloupek	 102623		

Betonářská lávka TRIO	Popis	Instrukce	Fakturace	Typ
	27.58 Výztuha v podlaze	 102621 (betonářská lávka pravá) 102622 (betonářská lávka leva)	 088216 088217	
	<ul style="list-style-type: none"> ■ prasklina ve sváru ■ deformovaná 	 102621 (betonářská lávka pravá) 102622 (betonářská lávka leva)	 088216 088217	
	27.59 Deformovaná výztuha	 102621 (betonářská lávka pravá) 102622 (betonářská lávka leva)	 088216 088217	

PERI Nájemní kritéria

TRIO





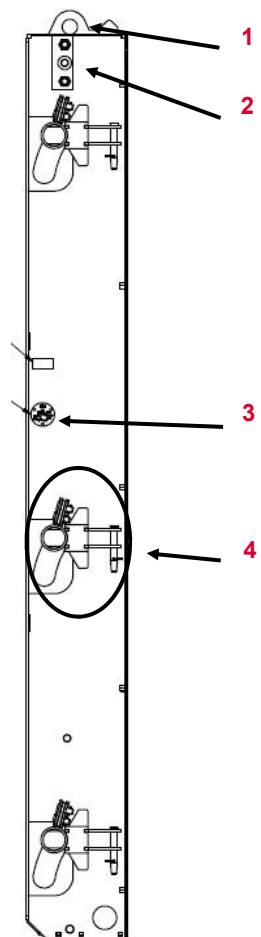





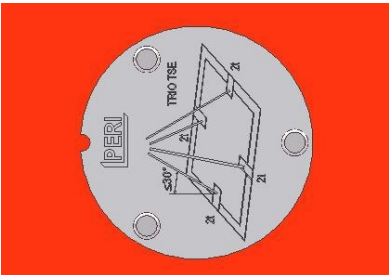















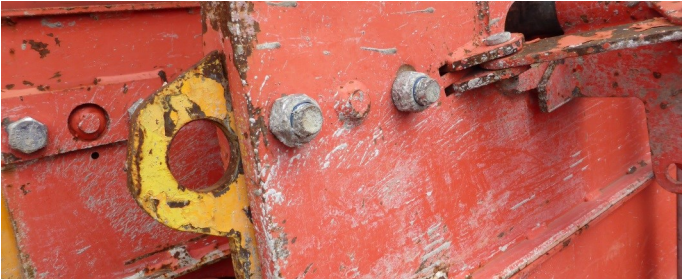

Šachtový díl TSE



Č.	Popis	Číslo výrobku
1	Jeřábové oko	108336
2	Zesílení TSE	113214
3	Informační štítek	105599
4	Uvolňovací zařízení	

Platné pro:	Číslo výrobku
Šachtový díl TSE 330	105525
Šachtový díl TSE 270	105523
Šachtový díl TSE 120	105524











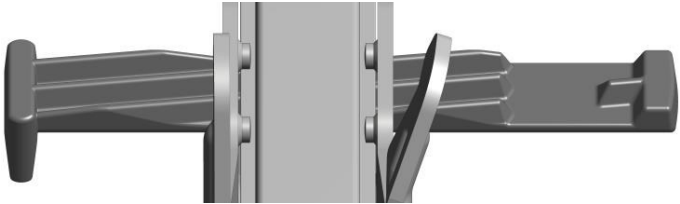



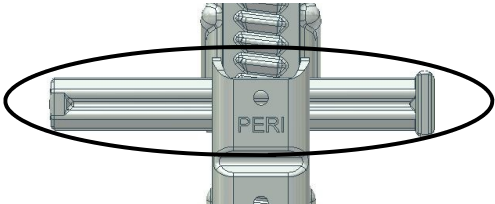

Šachtový díl TSE	Popis	Instrukce	Fakturace	Typ
	27.60 Chybějící informační štítek	 105599 („Hinweisschild“)		
	27.61 Deformovaná hrana			
	27.62 Nepohyblivé uvolňovací zařízení			

Šachtový díl TSE	Popis	Instrukce	Fakturace	Typ
	27.63 Ohnuté nebo chybějící jeřábové oko	 108336	 088208	
	27.64 Chybějící zesílení			
	27.65 Plech na uvolňovacím zařízení je ohnutý <ul style="list-style-type: none"> ■ je možné pohybovat ■ není možné pohybovat 		 088244	
			 088197	

PERI Nájemní kritéria

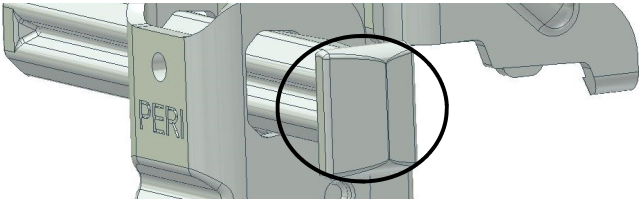
TRIO



Zámek BFD (023500)	Popis	Instrukce	Fakturace	Typ
	27.70 Ohnutá čelist		 088244	
	27.71 Rozebraný zámek		 088032	
	27.72 Klín je nefunkční — ohnutý nebo prasknutý	 		
	27.73 Odlomení hlavy klínu	 		

PERI Nájemní kritéria

TRIO





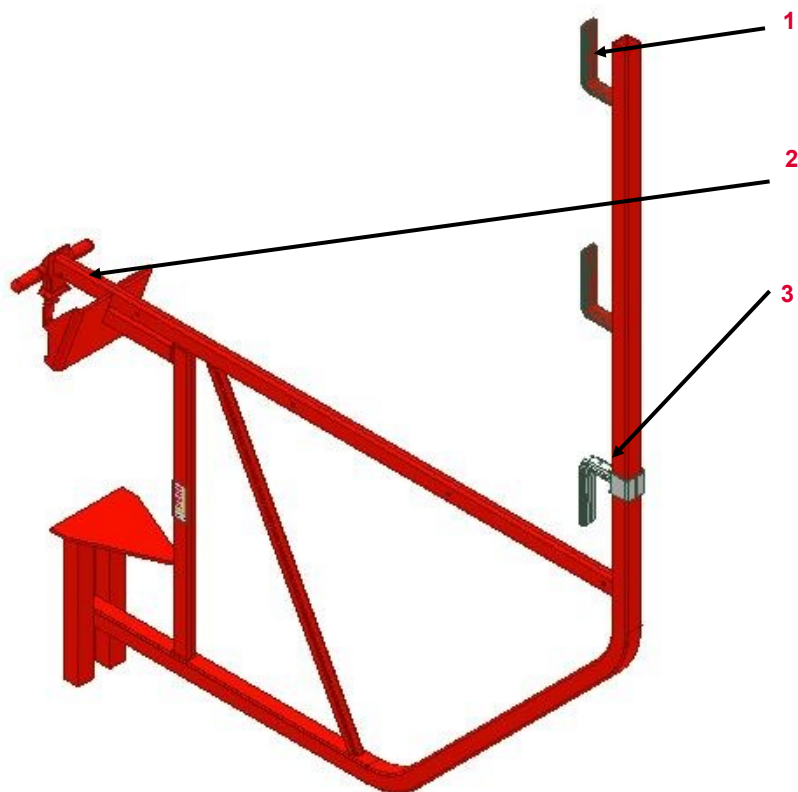











Konzola TRG

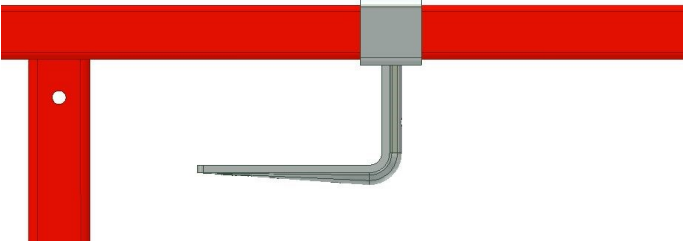

Č.	Popis	Číslo výrobku
1	Pevný držák	115543
2	Hlava	
3	Posuvný držák	115673

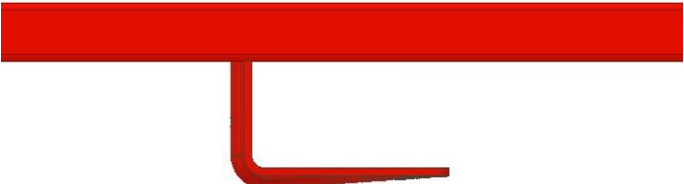
Platné pro:	Číslo výrobku
Konzola TRG 120	023680
Konzola TRG 80	023670

Konzola TRG	Popis	Instrukce	Fakturace	Typ
	27.74 Ohnutá hlava			
	27.75 Nekompletní konzola			
	27.76 Prohlubeniny v rámu <ul style="list-style-type: none"> ■ hrana není promáčknutá ■ hrana je promáčknutá 	<div style="margin-bottom: 10px;"></div>	<div style="margin-bottom: 10px;"></div>	<div style="margin-bottom: 10px;"></div>

Konzola TRG	Popis	Instrukce	Fakturace	Typ
	27.77 Prasklina ve sváru			
	<ul style="list-style-type: none"> ■ s poškozením rámu 			
	27.78 Deformovaný , chybějící posuvný držák	 115673	 088184	
	27.79 Deformovaný , chybějící pevný držák		 088000	

PERI Nájemní kritéria

TRIO



Konzola TRG	Popis	Instrukce	Fakturace	Typ
	<p>Ohnutá konzola</p> <ul style="list-style-type: none"> ■ < 5mm ■ 5– 10 mm ■ > 10 mm 	<ul style="list-style-type: none"> ✓ 🔨 🗑️ 🚫 	<ul style="list-style-type: none"> 🚫 📊 📊 	<ul style="list-style-type: none"> 👁️ 👁️ 🚫

PERI Nájemní kritéria

TRIO



Dorovňavací díl LA	Č.	Popis	Číslo výrobku
--------------------	----	-------	---------------

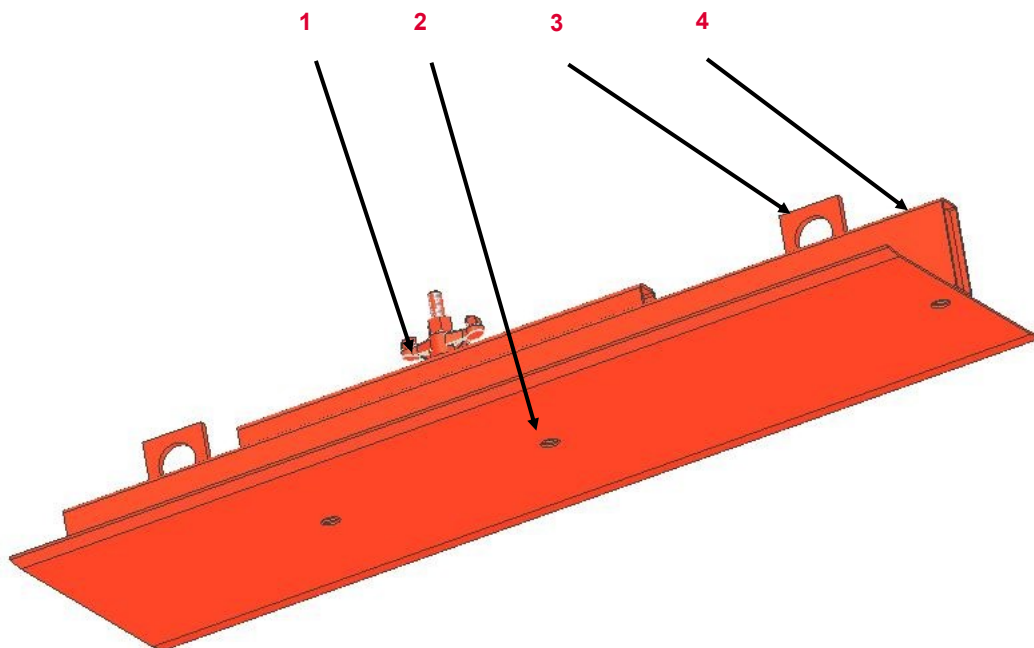

1	Křídlová matice	030100
2	Plocha k betonu	
3	Plech	740514
4	Profil	

Platné pro:	Číslo výrobku
Dorovňavací díl LA/4 330x36	054384
Dorovňavací díl LA 270x36	023170
Dorovňavací díl LA 120x36	023270

PERI Nájemní kritéria

TRIO

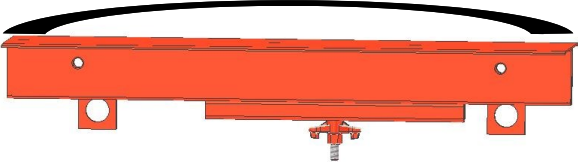
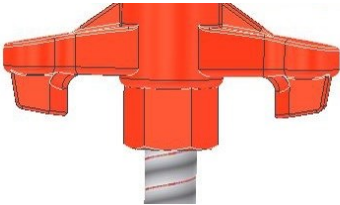
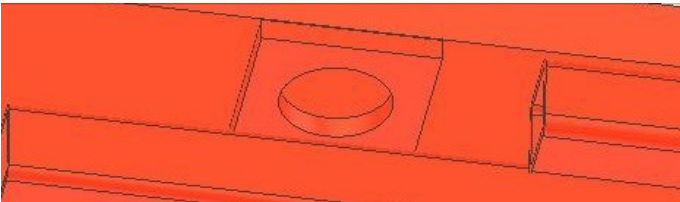
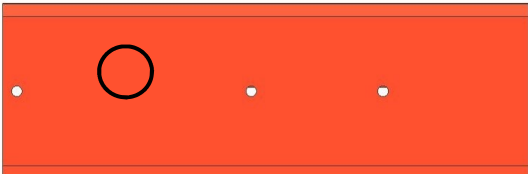

Dorovnávací díl LA	Popis	Instrukce	Fakturace	Typ
	<p>Ohnutý profil</p> <ul style="list-style-type: none"> ■ > 8 mm 			
	<p>Poškozená nebo chybějící matice</p>			
	<p>Prasklina nebo deformace v plechu</p>			
	<p>Prohlubenina v profilu</p>			

PERI Nájemní kritéria

TRIO





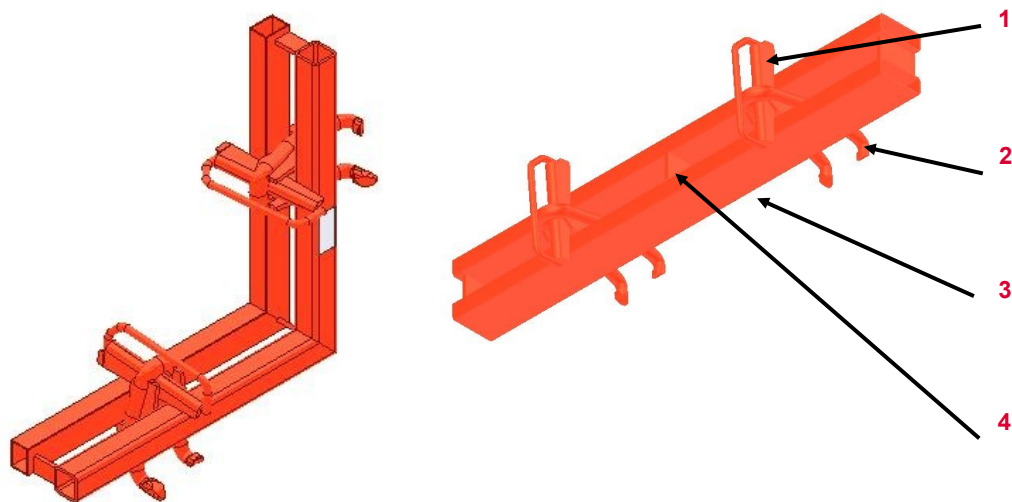









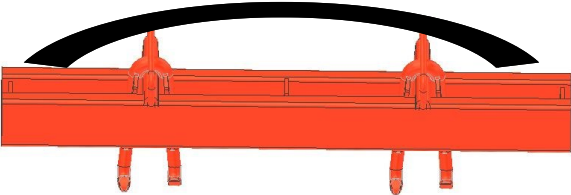

Závory	Č.	Popis	Číslo výrobku
--------	----	-------	---------------

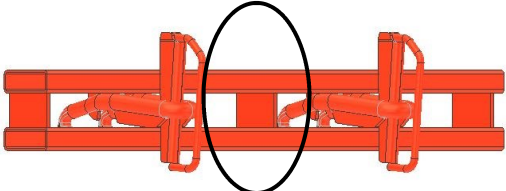

1	Klín	750585
2	Hákový třmen	751543
3	Profil	
4	Profile FI	

Platné pro:	Číslo výrobku
Vyrovnávací závora TAR 85	023550
Závora 85	023551
Rohová závora TVR 45/45	023560

























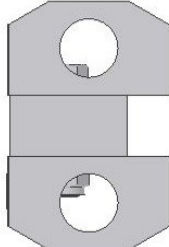

Závory	Popis	Instrukce	Fakturace	Typ
	27.84 Poškozený kiln nebo hákový třmen	 751543 (TVR) 751544 (TAR) 750585 (pro oba)	 088210 088209	
	27.85 Ohnutý profil ■ > 5 mm a ≤ 10 mm ■ > 10 mm	 	 088244 	 
	27.86 Chybějící profile fl.			

PERI Nájemní kritéria

TRIO

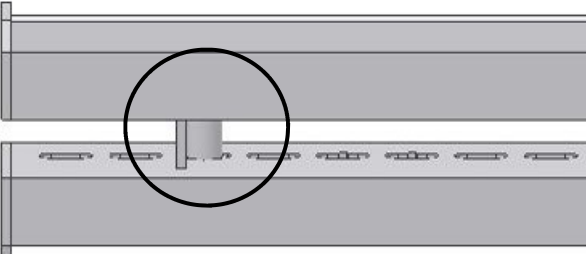













Závory	Popis	Instrukce	Fakturace	Typ
	Prasklá závora (roh) <ul style="list-style-type: none"> ■ ≤ 2 cm délky 		 088028	
	<ul style="list-style-type: none"> ■ > 2 cm 	 		
	Prasklý svár		 088028	

Univerzální závora 245 (023920)	Popis	Instrukce	Fakturace	Typ	
	<p>27.87 Ohnutí</p> <ul style="list-style-type: none"> ■ > 8 mm 				
	<p>27.88 Ohnutý, chybějící čelní plech</p>			<p>088155</p>	
	<p>27.89 Chybějící vymežovač</p>	 <p>104178 (vymežovač) 024910 (šroub) 781053 (matice) 024180 (podložka)</p>		<p>088211</p>	

PERI Nájemní kritéria

TRIO



TRIO Hlava pro stabilizátor (023660)	Popis	Instrukce	Fakturace	Typ		
	27.90 Prasklina ve sváru					
	27.91 Poškozené, ohnuté			088244		
	27.92 Poškozený závit v křídlové matici			030190 (Křídlová matice)	088541	

PERI Nájemní kritéria

TRIO



Paletová příloška MAXIMO (115058)	Popis	Instrukce	Fakturace	Typ
	27.93 Deformovaný profil		 088244	
	27.94 Prasklina ve sváru	 		
	27.95 Chybějící nebo nečitelný štítek		 088037	
	27.96 Ohnutý hák		 088244	

PERI Nájemní kritéria

TRIO

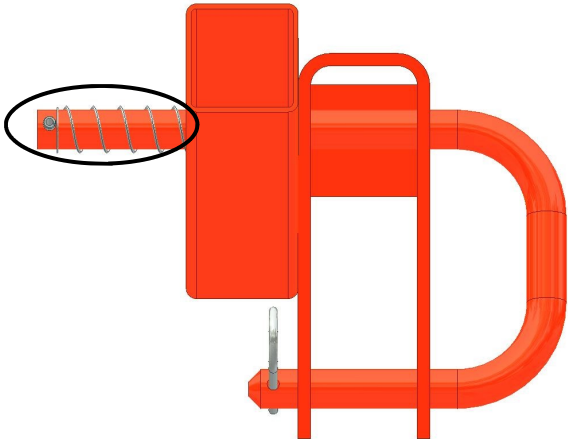
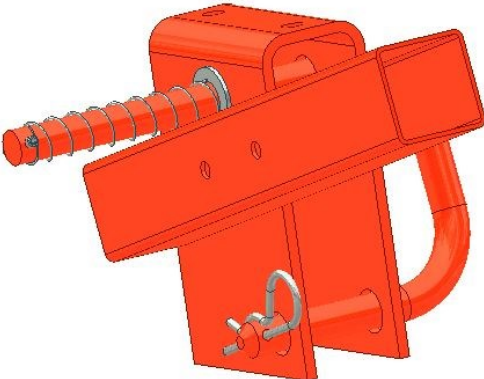

Držák sloupku zábradlí TRIO (101592)	Popis	Instrukce	Fakturace	Typ
	27.100 Nefunkční pružinka	 721816 (pružinka)		
	27.101 Ohnutí		 088244	

Sloupek zábradlí HSGP-2 (116292)	Popis	Instrukce	Fakturace	Typ
	27.97 Deformovaný nebo chybějící posuvný držák	Posuvný držák (115673)	088184	
	27.98 Deformovaný nebo chybějící pevný držák		088000	
	27.99 Ohnutí, deformace			
	<ul style="list-style-type: none"> ■ > 5—10 mm 			
	<ul style="list-style-type: none"> ■ > 10mm 			

PERI Nájemní kritéria

TRIO



Napínák OC. Pásy TRIO (023010)	Popis	Instrukce	Fakturace	Typ
	Prasklá matice			
	Chybějící nebo poškozený čep	<p>722927 (Zástrčka 16x 220) 722929 (Upínací kolík)</p>	<p>088180</p>	

PERI Nájemní kritéria

Vysvětlivky znaků



Znak	Význam	Znak	Význam	Znak	Význam
	Není v pořádku – materiál je poškozený		Fakturuje se zákazníkovi		Optické poškození
	OK – materiál zůstává v nájemním skladu		Nefakturuje se zákazníkovi		Funkční poškození
	Poškozený materiál – není dovoleno vydávat materiál z bezpečnostních důvodů		Zkrácení prvku		Funkční poškození — není dovoleno vydávat materiál z bezpečnostních důvodů
	Oprava dle instrukcí		Označení prvku barvou		Statické poškození — není dovoleno vydávat materiál z bezpečnostních důvodů
	Oprava za studena — poté kontrola svárů a sousedních dílů		Výměna poškozeného dílu		
	Oprava po výpočtu hospodárnosti		Doplnění chybějícího dílu		
	Očištění materiálu				