

# PERI Nájemní kritéria

## VARIO Příslušenství

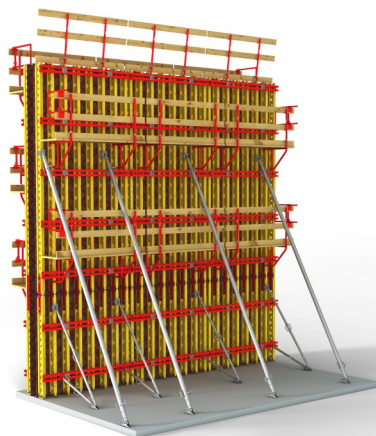

### Kontakt

**PERI, spol. s r.o.**  
**bednění řešení služby**

Průmyslová 392  
252 42 Jesenice u Prahy  
tel.: 222 359 311  
info@peri.cz  
www.peri.cz

Obsah	Str.	Provedené změny	Datum   Iniciály	Str.
Spony	2	Nová verze	01/2018   fw	
Jeřábový hák-2 VT20	17	Přidán Poklesový klín	07/2021   fw	30
Hlava Upínacího Válcu SRU	19			
Příslušenství	20			
Vysvětlivky	33			

# PERI Nájemní kritéria

## VARIO Příslušenství



### Spona HB 24-100/120 | 24-140/160

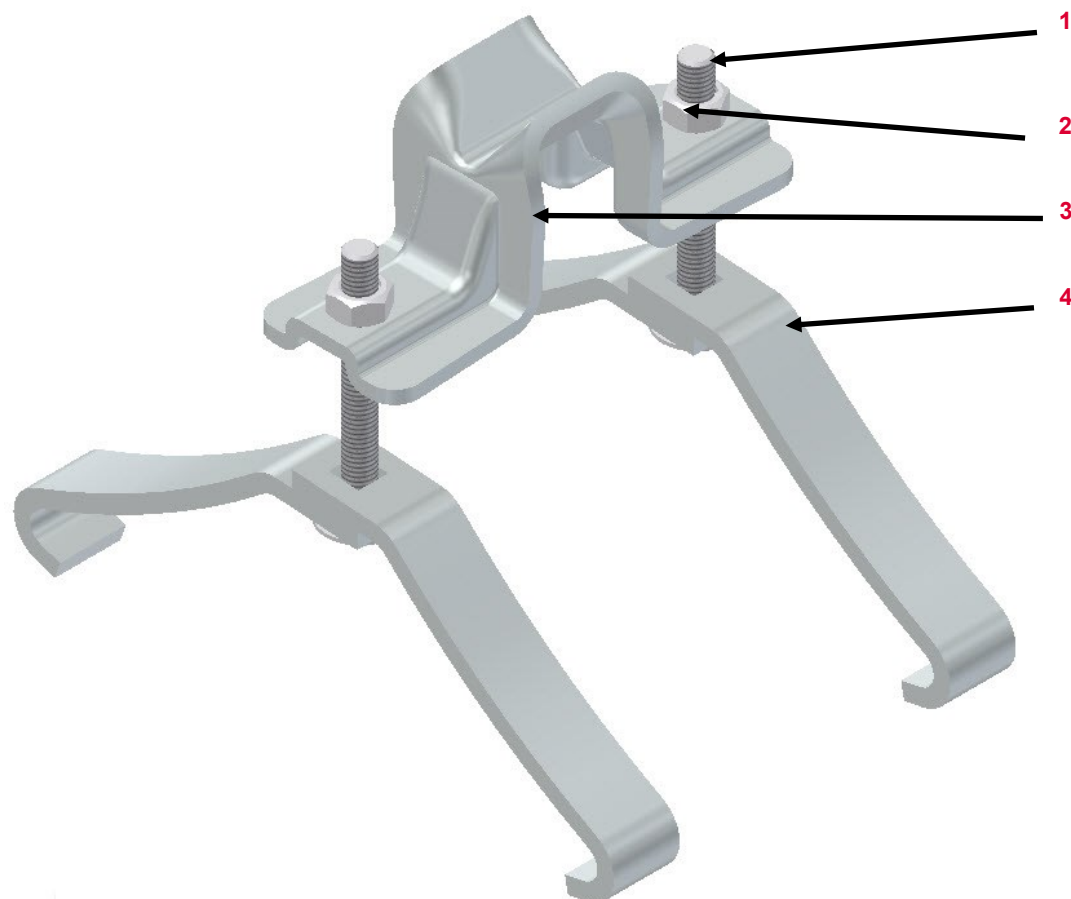

Číslo	Jméno	Číslo výrobku
1	Šroub	126228
2	Matice	024090
3	Příčná rukojeť HB-GT24 POZ.	710253
4	Poutko pro HB 24-100/120	024040
4	Poutko pro HB 24-140/160	722690

Platné pro:	Číslo výrobku
Spona HB 24-100/120	024070
Spona HB 24-140/160	

# PERI Nájemní kritéria

## VARIO Příslušenství



Spona HB 24-100/120   24-140/160	Popis	Instrukce	Fakturace	Typ
----------------------------------	-------	-----------	-----------	-----



### Šroub | Matice

■ Chybí



■ Ohnuté



■ Zrezivělé



### Poutko pro HB

■ Chybí

















■ Ohnuté



# PERI Nájemní kritéria VARIO Příslušenství



Spona HB 24-100/120   24-140/160	Popis	Instrukce	Fakturace	Typ
	<b>Rez</b>	<ul style="list-style-type: none"> <li>■ Stupeň rzi A; B nebo C </li> </ul>		
	<ul style="list-style-type: none"> <li>■ Stupeň rzi &gt; C</li> </ul>			
	<b>Velké znečištění</b>	<ul style="list-style-type: none"> <li>■ Lze očistit </li> </ul>		
	<ul style="list-style-type: none"> <li>■ Nelze očistit, znečištěné části lze nahradit</li> </ul>			
	<ul style="list-style-type: none"> <li>■ Nelze očistit a znečištěné části nelze nahradit</li> </ul>			

# PERI Nájemní kritéria

## VARIO Příslušenství



Spona Uni HBU	Číslo	Jméno	Číslo výrobku
---------------	-------	-------	---------------

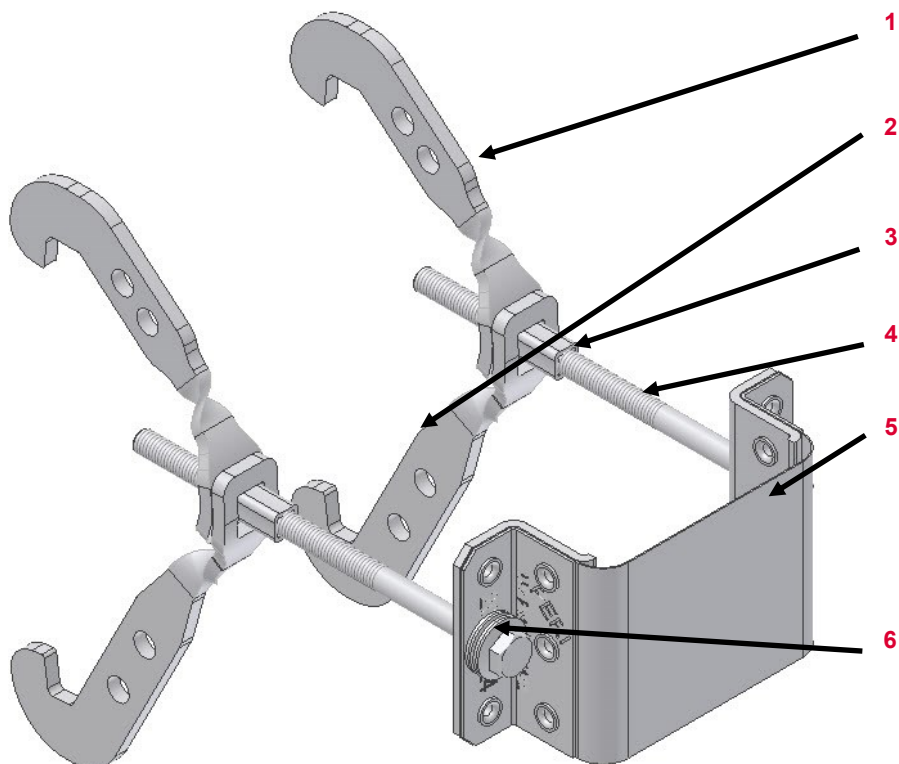

1	Spojka HBU/*HBUD 123	103840
2	Spojka HBU/*HBUD 160	103842
3	Závit. Objímka HBU/ HBUD	103844
4	Šroub	
5	Plech	
6	Podložka	109870

Valid for	Article number
Spona UNI HBU 24-28	103845
Spona UNI HBU 20-24	104931
Spona UNI HBU 16-26 U200	111806
Dvojitá Spona UNI HBUD 24-28	104096
Dvojitá Spona UNI HBUD 20-24	104930
Spona MPB 24/GT24	111000

# PERI Nájemní kritéria VARIO Příslušenství



Spona Uni HBU	Popis	Instrukce	Fakturace	Typ
---------------	-------	-----------	-----------	-----



Všechny části spony jsou kompletně znečištěny betonem

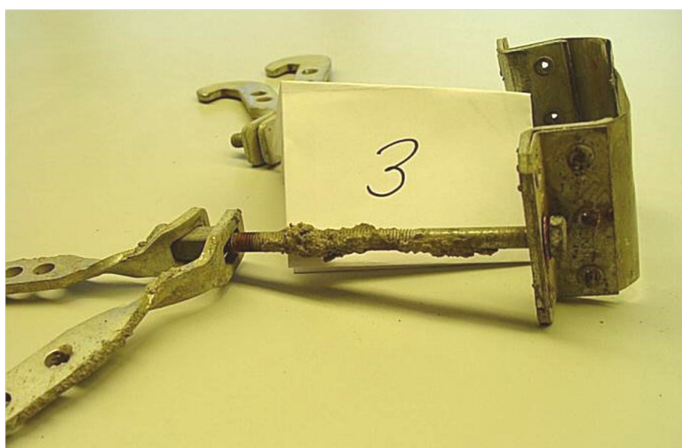



Šroub je znečištěn betonem













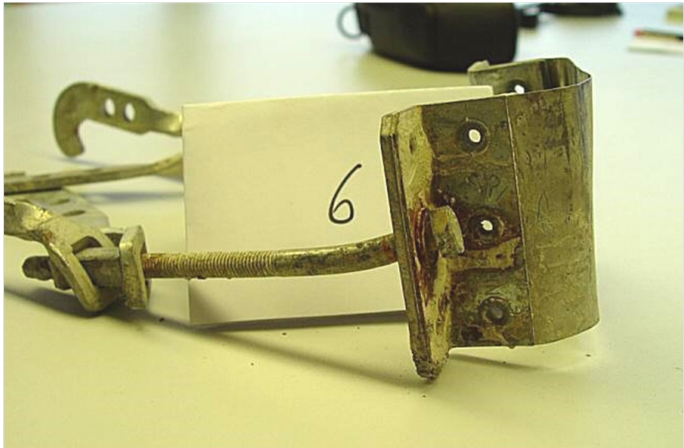



# PERI Nájemní kritéria VARIO Příslušenství



Spona Uni HBU	Popis	Instrukce	Fakturace	Typ
	<p><b>Plech je znečištěný betonem</b></p> <ul style="list-style-type: none"> <li>■ Šrouby lze utáhnout</li> <li>■ Silné znečištění</li> </ul>	<p>✓</p> <p>⚙️</p>	<p>🚫</p> <p>📦</p>	<p>👁️</p> <p>⚙️</p>
	<p><b>Ohnutá spona</b></p>	<p>⚙️</p>	<p>📦</p>	<p>⚙️</p>

# PERI Nájemní kritéria VARIO Příslušenství



Spona Uni HBU	Popis	Instrukce	Fakturace	Typ
	Ohnutý šroub			
	<p><b>Rez</b></p> <ul style="list-style-type: none"> <li>■ Šrouby nelze utáhnout</li> <li>■ Třída rzi A, B nebo C</li> <li>■ Třída rzi D</li> </ul>			
				
				



# PERI Nájemní kritéria VARIO Příslušenství

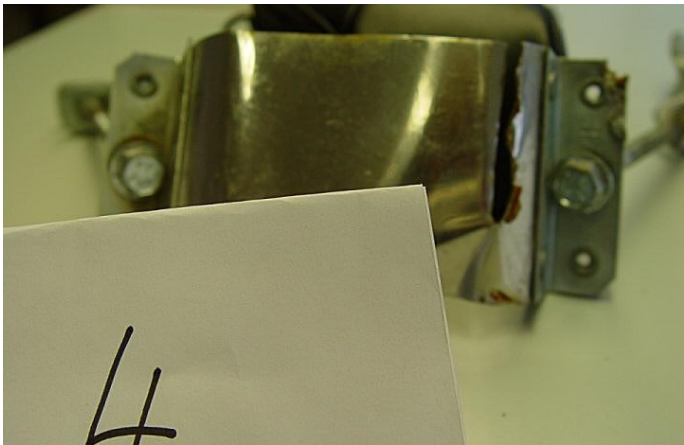

Spona Uni HBU	Popis	Instrukce	Fakturace	Typ
	<p><b>Ohnutý plech</b></p> <ul style="list-style-type: none"> <li>■ Jemné ohnutí</li> <li>■ Promáčknutí</li> </ul>	<p>✓</p> <p>⚙️</p>	<p>🚫</p> <p>🌀</p>	<p>👁️</p> <p>⚙️</p>
	<p><b>Praskliny (naříznutí) v plechu</b></p>	<p>⚙️</p>	<p>🌀</p>	<p>⚙️</p>

# PERI Nájemní kritéria VARIO Příslušenství



Spona Uni HBU	Popis	Instrukce	Fakturace	Typ
	<b>Díry po hřebících ( šroubech)</b>			
	■ ≤ 25 % ztráty materiálu	✓	✗	👁️
	■ > 25 % ztráty materiálu	🧮	✗	⚙️
	■ Díry > Ø 5 mm	🧮	🌀	⚙️
	<b>Promáčknutí v plechu</b>			
	■ ≤ Ø 2 cm	✓	✗	👁️
	■ > Ø 2 cm	⚙️	🌀	⚙️

# PERI Nájemní kritéria

## VARIO Příslušenství



Spona HB	Číslo	Jméno	Číslo výrobku
----------	-------	-------	---------------

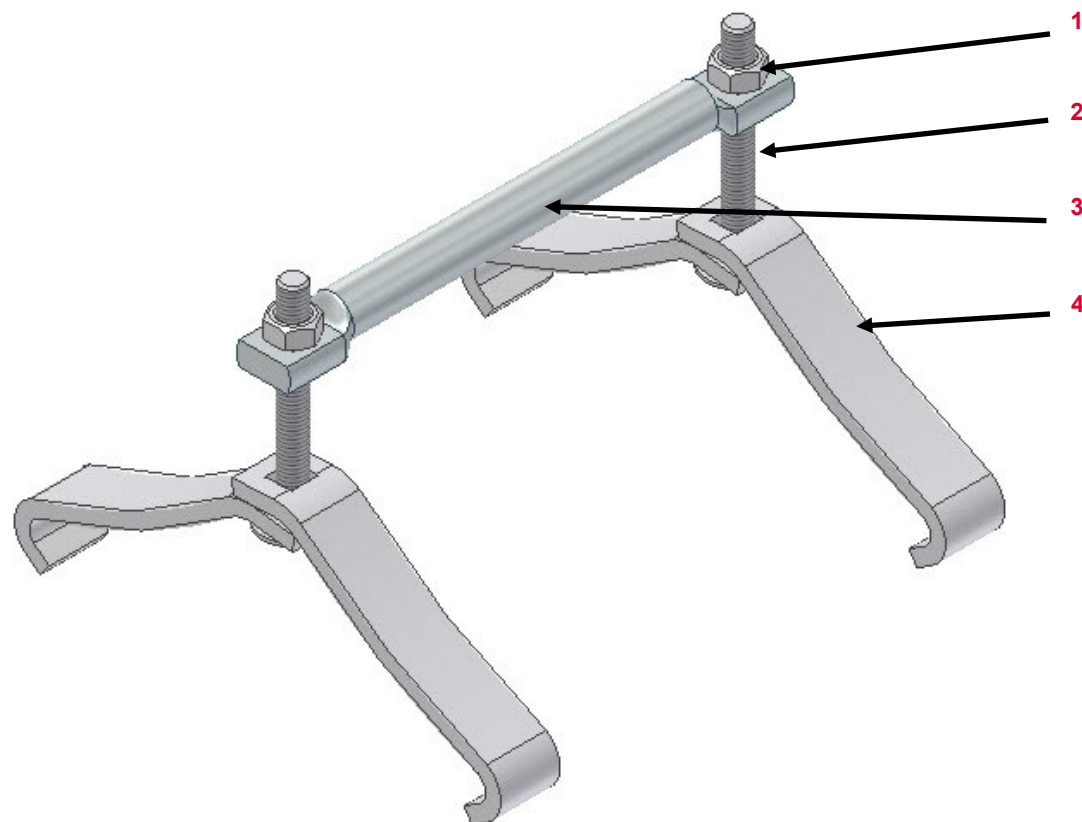





















1	Matice	024090
2	Šroub	
3	Oc. Čepička POZINK GT 24/2	726041
4	Poutko pro HB	024040

Platné pro	Číslo výrobku
Spona HB HB	024110
Spona HB šikmá	024860
Dvojitá spona DHB GT 24	024170

# PERI Nájemní kritéria VARIO Příslušenství



Spona HB	Popis	Instrukce	Fakturace	Typ
	Šrouby   Matice   Poutka			
	■ Chybí			
	■ Poškozeno silou			
■ Znečištěno				
	Oc. Čepička Pozink GT 24/2			
	■ Chybí			
	■ Poškozeno silou			
■ Znečištěno				

# PERI Nájemní kritéria

## VARIO Příslušenství



Spona HB pro VT (024880)	Číslo	Jméno	Číslo výrobku
--------------------------	-------	-------	---------------

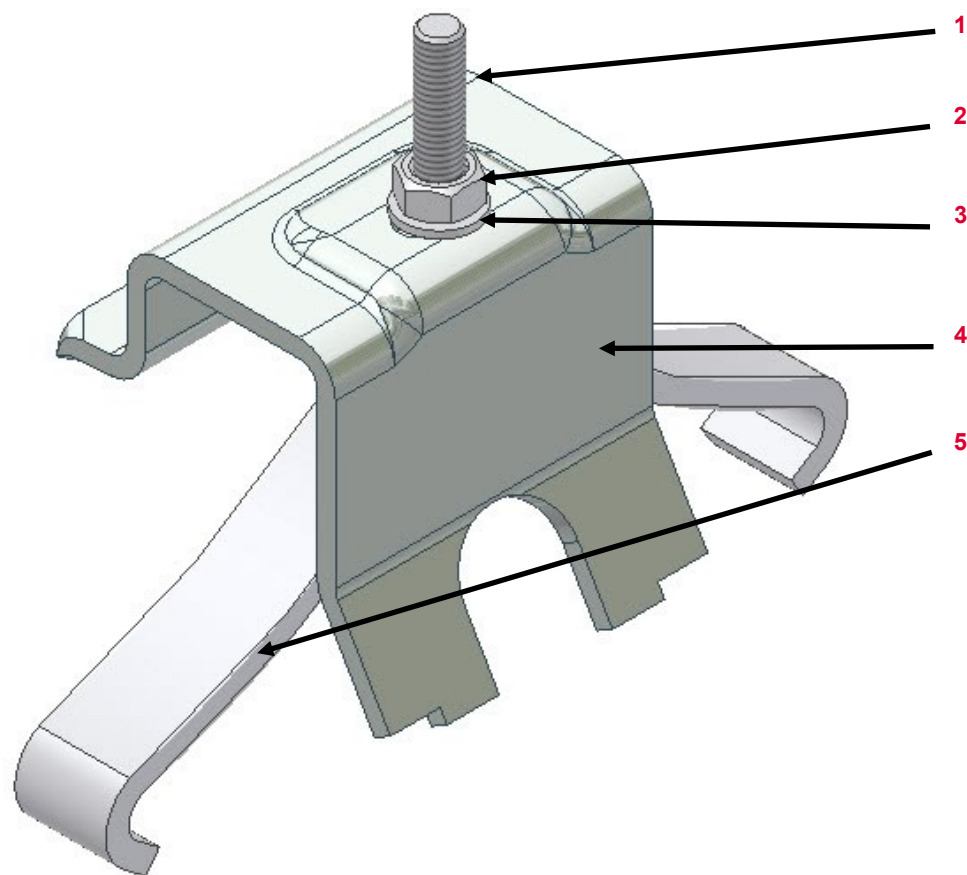

1	Šroub	126228
2	Matice	024090
3	Podložka	780354
4	„Můstek“	721833
5	Poutko pro HB	024040

# PERI Nájemní kritéria

## VARIO Příslušenství



### Pevná Spona U100-120 (024630)

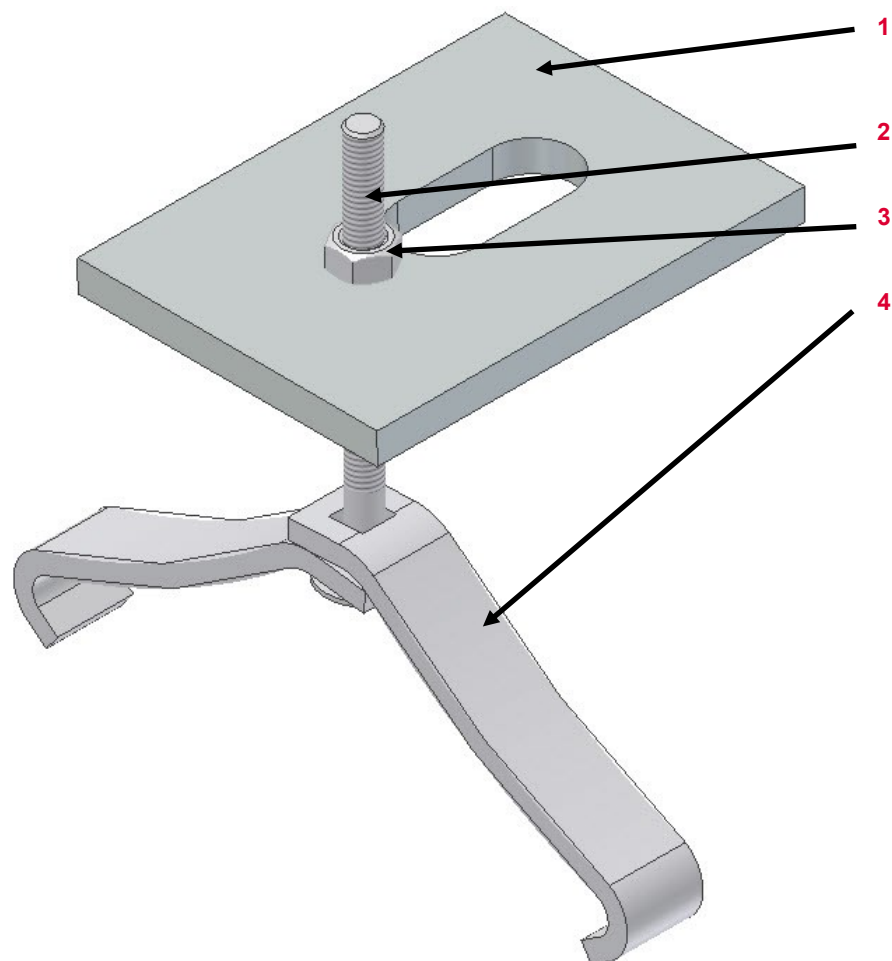

Číslo	Jméno	Číslo výrobku
1	Tlakový plech	722670
2	Šroub	710249
3	Matice	024090
4	Poutko pro HB	024040

# PERI Nájemní kritéria

## VARIO Příslušenství

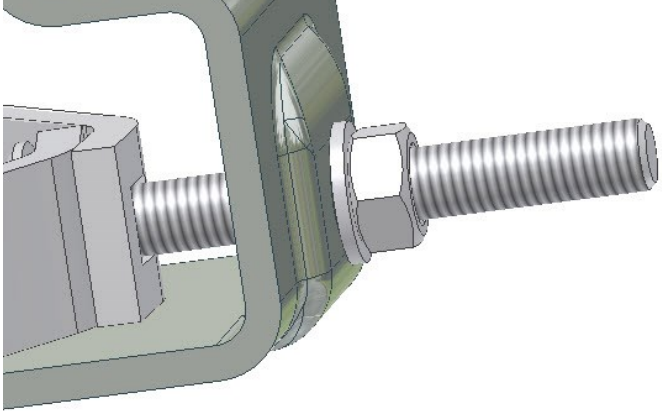
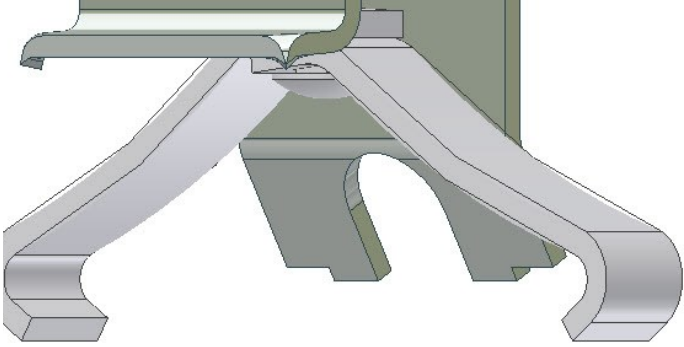

Spona HB pro VT (024880) Pevná Spona U100-120 (024630)	Popis	Instrukce	Fakturace	Typ
	<b>Šroub   Matice   Podložka</b>			
	■ Chybí			
	■ Poškozeno silou			
	■ Znečištěno			
	<b>Hook</b>			
	■ Chybí			
	■ Poškozeno silou			
	■ Znečištěno			

# PERI Nájemní kritéria

## VARIO Příslušenství



Spona HB pro VT (024880) Pevná Spona U100-120 (024630)    Popis    Instrukce    Fakturace    Typ

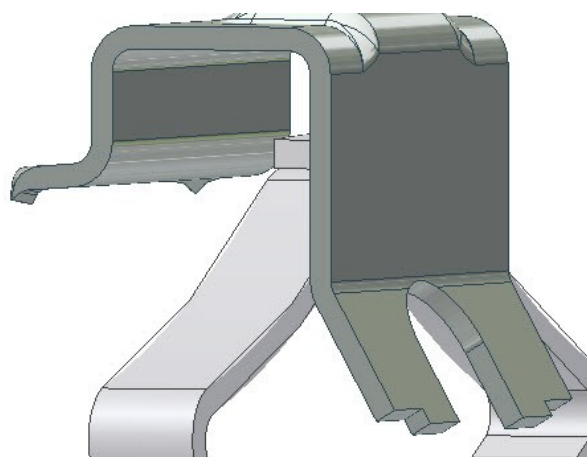

Ohnutý můstek

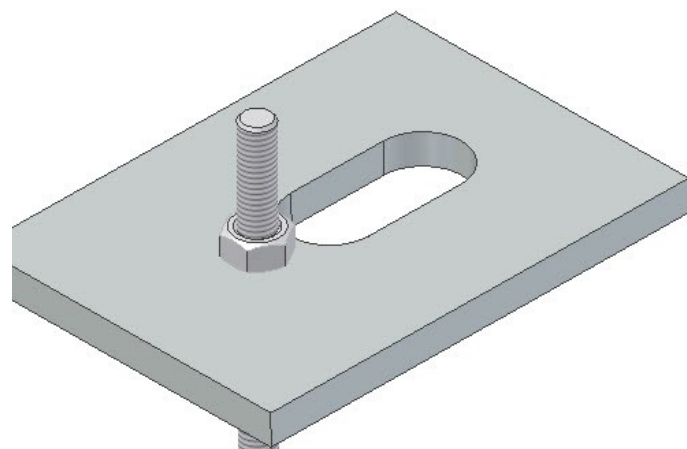

Tlakový plech

■ Ohnutý



■ Chybí





# PERI Nájemní kritéria

## VARIO Příslušenství



### Jeřabový hák-2 VT20 (113712)



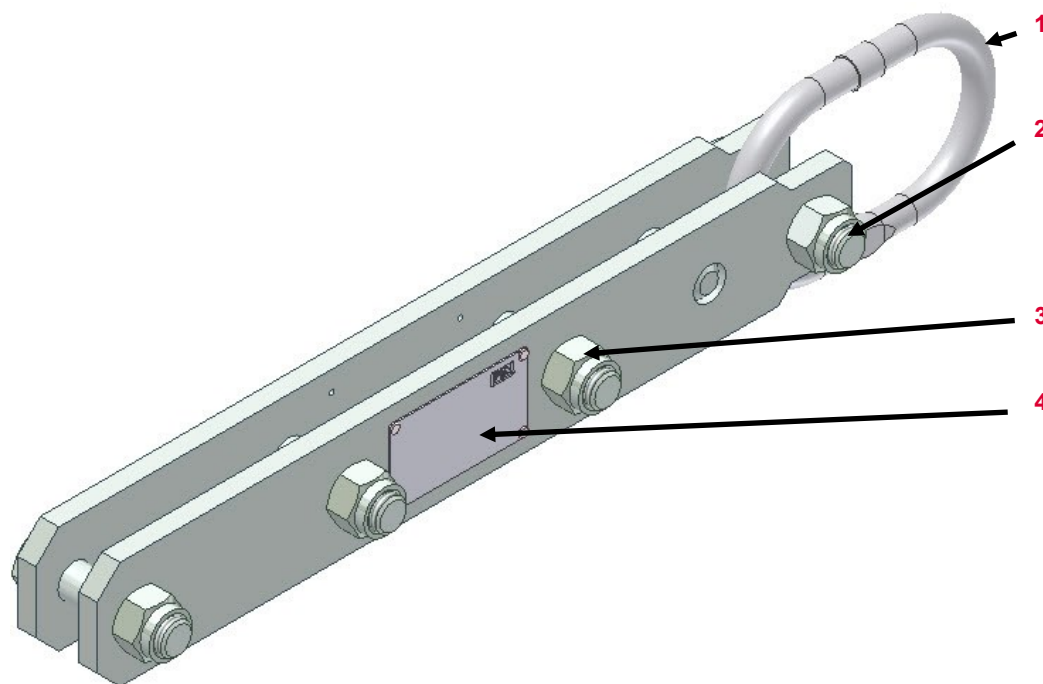







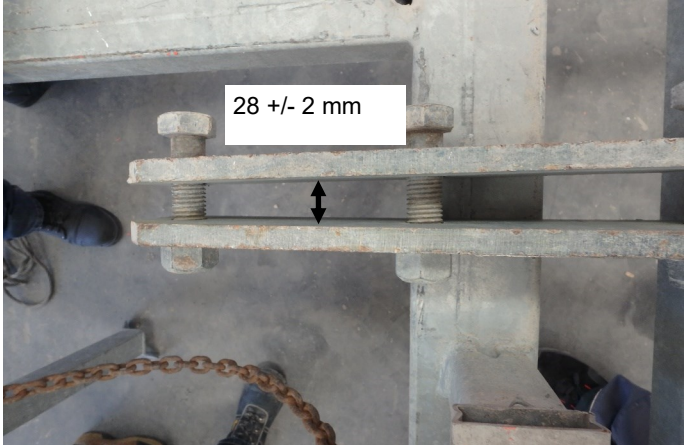





Číslo      Jméno      Číslo výrobku



1	Závěsné Oko	106894
2	Šroub	024900
3	Matice	781053
4	Typový štítek	113721

# PERI Nájemní kritéria VARIO Příslušenství



Jeřábový hák-2 VT20 (113712)	Popis	Instrukce	Fakturace	Typ
	<b>Ohnutí</b>			
	<ul style="list-style-type: none"> <li>■ V toleranci</li> </ul>			
	<ul style="list-style-type: none"> <li>■ Mimo tolerance, ale lze srovnat</li> </ul>			
<ul style="list-style-type: none"> <li>■ Mimo toleranci , Neopravitelné</li> </ul>				
	<b>Šrouby   Matice</b>			
	<ul style="list-style-type: none"> <li>■ Chybí</li> </ul>			
<ul style="list-style-type: none"> <li>■ Poškozeno silou</li> </ul>				

# PERI Nájemní kritéria

## VARIO Příslušenství



Jeřábový hák-2 VT20 (113712)	Popis	Instrukce	Fakturace	Typ
------------------------------	-------	-----------	-----------	-----



### Typový štítek

■ Chybí



■ Nečitelný

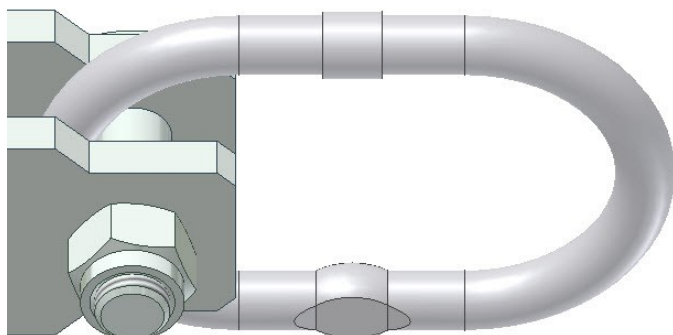

### Závěsné oko

■ Opotřebované ( $\varnothing < 9$  mm)



■ Chybí



# PERI Nájemní kritéria

## VARIO Příslušenství



### Hlava Upínacího Válc SRU (110756)



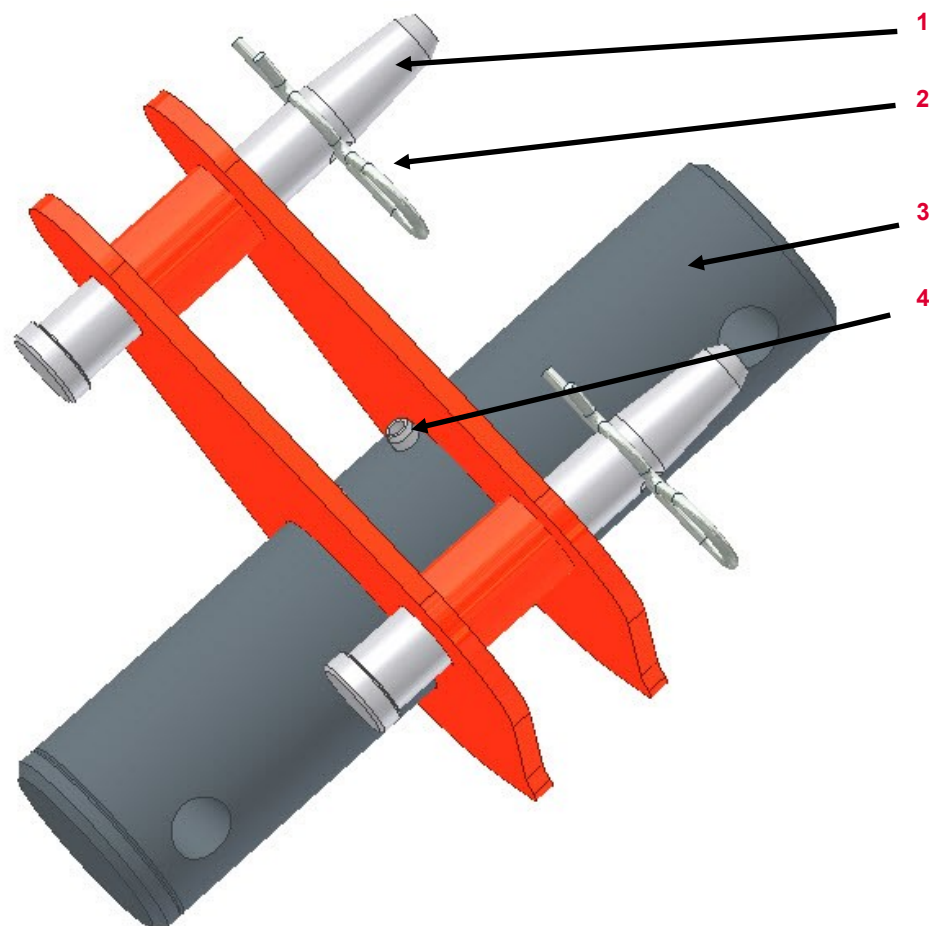









Číslo	Jméno	Číslo výrobku
-------	-------	---------------



1	Čep	105400
2	Závlačka	018060
3	Upínací válec D60x250	131352
4	Nap. Vložka 8 X 70	770013











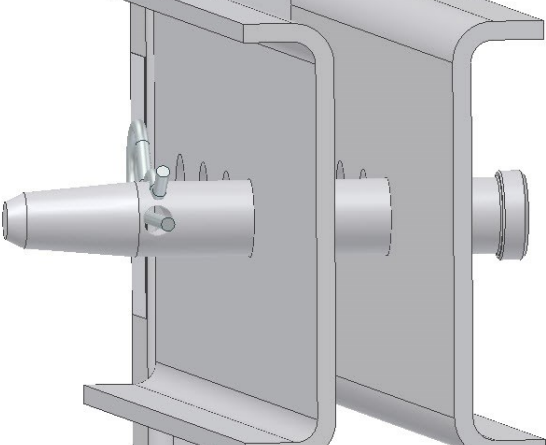

# PERI Nájemní kritéria VARIO Příslušenství



Hlava Upínacího Válc SRU (110756)	Popis	Instrukce	Fakturace	Typ
	<p>Čep   Závlačka   Nap. vložka   Upínací válec</p>	<p> 105400 (Čep) 018060 (Závlačka)</p>		
	<p>■ Poškozeno silou</p>	<p> 105400 (Čep) 018060 (Závlačka)</p>		
	<p>Ohnutí</p>	<p></p>		
	<p>■ Nelze narovnat</p>	<p> </p>		

# PERI Nájemní kritéria VARIO Příslušenství







Držák zábradlí GT24/VT20 (101290)	Popis	Instrukce	Fakturace	Typ
	<b>Čep   Závlačka</b>			
	■ Chybí	 105400 (Čep) 018060 (Závlačka)		
	■ Poškozeno silou	 105400 (Čep) 018060 (Závlačka)		
	<b>Ohnutí</b>			
■ Lze narovnat				
■ Nelze narovnat				

# PERI Nájemní kritéria

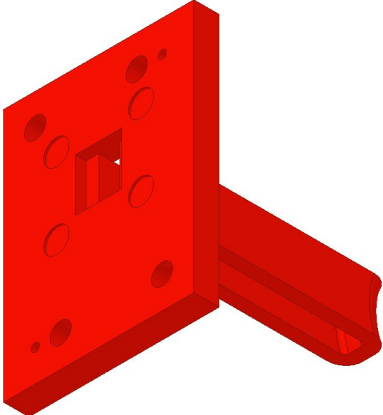
## VARIO Příslušenství



Tlaková podložka KDP (024220)	Popis	Instrukce	Fakturace	Typ
	Ohnutí			

# PERI Nájemní kritéria VARIO Příslušenství



Lišta Pro Nastavení Nosníku 24-2 (024480)	Popis	Instrukce	Fakturace	Typ
---	-------	-----------	-----------	-----

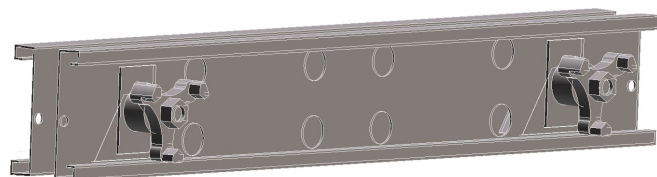

### Ohnutí

■ Lze srovnat



■ Nelze srovnat

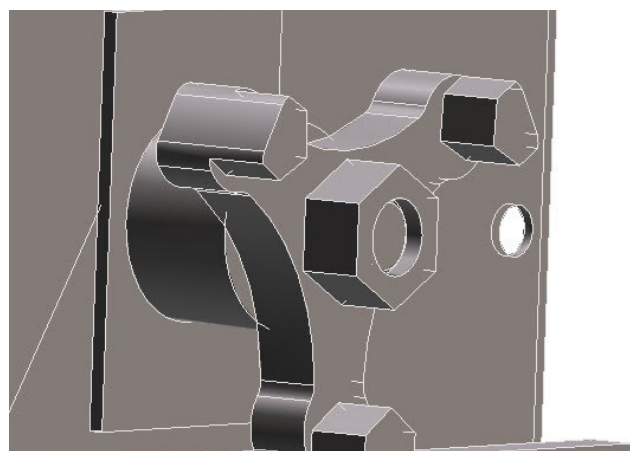

### Trojkrídla matice DW 15

■ Chybí



030190 (Trojkřídlá matice DW 15)



■ Poškozená silou





030190 (Trojkřídlá matice DW 15)















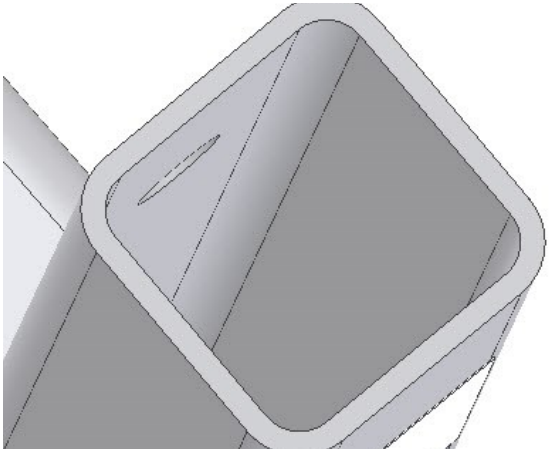

# PERI Nájemní kritéria VARIO Příslušenství

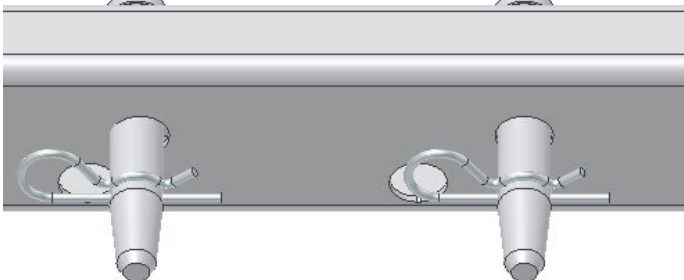

Krajní Spona HB (024600)	Popis	Instrukce	Fakturace	Typ
	<b>Šroub   Matice   Poutko pro HB</b>	 710249 (Šroub) 024090 (Matice) 024040 (Poutko pro HB)		
	■ Chybí	 710249 (Šroub) 024090 (Matice) 024040 (Poutko pro HB)		
	■ Poškozeno silou			
	<b>Zpevnění konce Nosniku</b>	 710968 (Zpevnění konce Nosniku)		

# PERI Nájemní kritéria VARIO Příslušenství











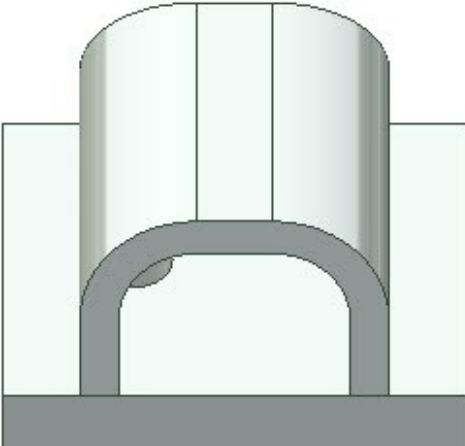





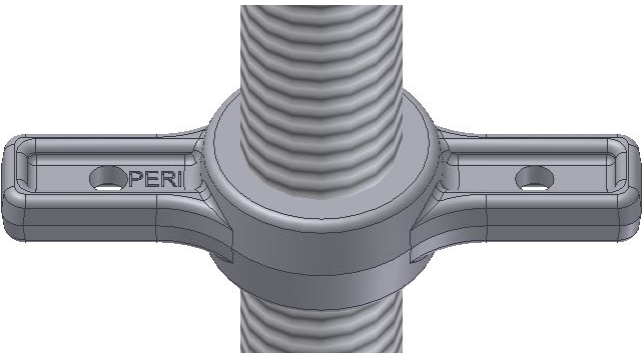







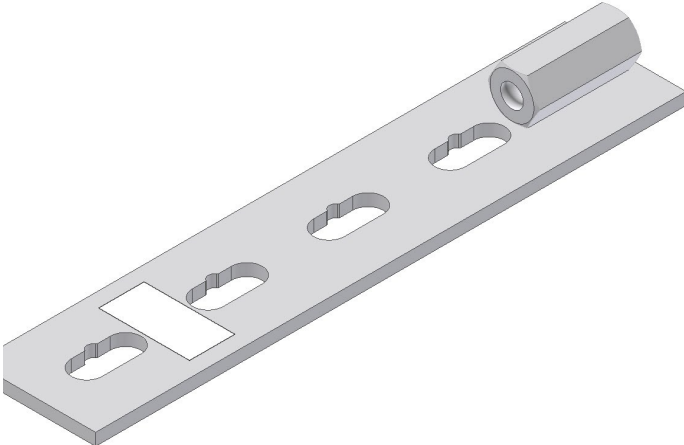

Držák zábradlí SRU/SRZ (104131)	Popis	Instrukce	Fakturace	Typ
	<b>Ohnutá Trubka</b>			
	<ul style="list-style-type: none"> <li>■ Lze narovnat</li> </ul>			
	<ul style="list-style-type: none"> <li>■ Nelze narovnat</li> </ul>			
	<b>Čep   Závlačka</b>			
	<ul style="list-style-type: none"> <li>■ Chybí</li> </ul>	 105400 (Čep) 018060 (Závlačka)		
	<ul style="list-style-type: none"> <li>■ Poškozeno silou</li> </ul>	 105400 (Čep) 018060 (Závlačka)		

# PERI Nájemní kritéria

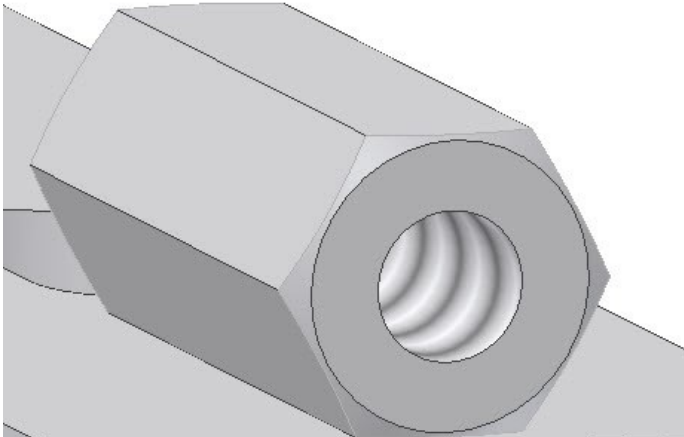
## VARIO Příslušenství



Hlava SRU (109630)	Popis	Instrukce	Fakturace	Typ
	<b>Ohnutá hlava</b> <ul style="list-style-type: none"> <li>■ Lze srovnat</li> </ul>			
	<ul style="list-style-type: none"> <li>■ Nelze srovnat</li> </ul>			
	<b>Utahovací Matice 38</b> <ul style="list-style-type: none"> <li>■ Chybí</li> </ul>			
	<ul style="list-style-type: none"> <li>■ Poškozena silou</li> </ul>			

Čelní příložka (013240)	Popis	Instrukce	Fakturace	Typ
	<b>Ohnutí</b>			
	<ul style="list-style-type: none"> <li>■ Lze narovnat</li> </ul>			
	<ul style="list-style-type: none"> <li>■ Nelze narovnat</li> </ul>			
	<b>Nefunkční závit</b>			
	<ul style="list-style-type: none"> <li>■ Opatřebován</li> </ul>			
	<ul style="list-style-type: none"> <li>■ Poškozeno silou</li> </ul>			

# PERI Nájemní kritéria VARIO Příslušenství



Poklesový Klín 420 KN (024590; 117930)	Popis	Instrukce	Fakturace	Typ
--	-------	-----------	-----------	-----

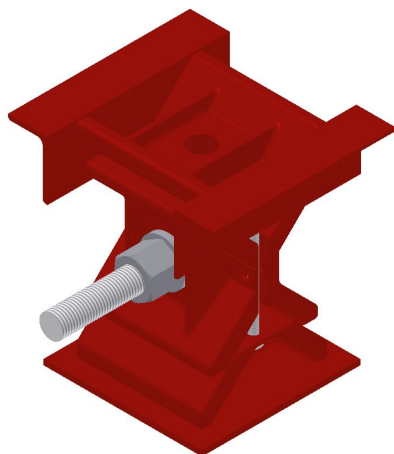

### Nefunkční

■ Nefunkční z důvodu opotřebení



■ Nefunkční z důvodu poškození



### Ohnutí

■ Lze narovnat



■ Nelze narovnat



# PERI Nájemní kritéria

## VARIO Příslušenství



Poklesový Klín 420 KN (024590; 117930)	Popis	Instrukce	Fakturace	Typ
--	-------	-----------	-----------	-----



Řez v horní desce



Řez v dolní desce



# PERI Nájemní kritéria











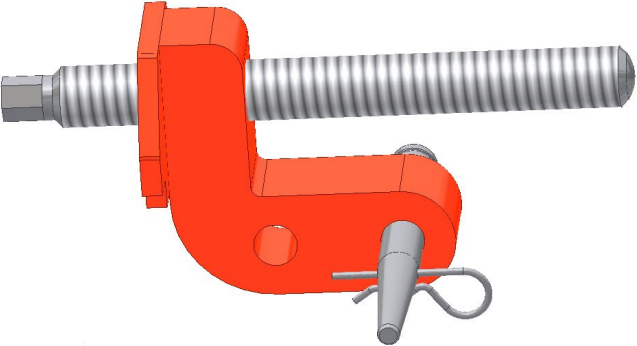

## VARIO Příslušenství

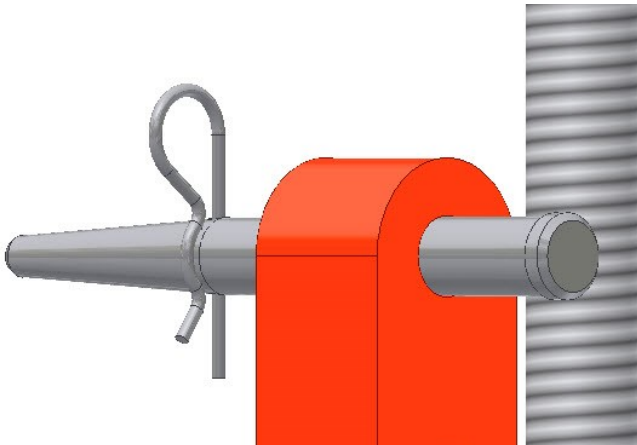

Pracovní Vidlice GT/VT (070740)	Popis	Instrukce	Fakturace	Typ
	<b>Ohnuté vidle</b>			
	■ Lze narovnat			
	■ Nelze narovnat			
	<b>Celý výrobek je ohnutý</b>			
	■ Lze narovnat			
	■ Nelze narovnat			

# PERI Nájemní kritéria VARIO Příslušenství



















Rektif. Jednotka SRU (111135)	Popis	Instrukce	Fakturace	Typ
	<b>Vřeteno</b>			
	■ Opotřebované	 111132 (Vřeteno)		
	■ Poškozené silou	 111132 (Vřeteno)		
	<b>Čep   Závlačka</b>			
	■ Chybí	 104031 (Čep) 018060 (Závlačka)		
	■ Poškozeno silou	 104031 (Čep) 018060 (Závlačka)		



# PERI Nájemní kritéria

## Vysvětlivky



Znak	Význam	Znak	Význam	Znak	Význam
	Není v pořádku – materiál je poškozený		Fakturuje se zákazníkovi		Optické poškození
	OK – materiál zůstává v nájemním skladu		Nefakturuje se zákazníkovi		Funkční poškození
	Poškozený materiál – <b>není dovoleno</b> vydávat materiál z bezpečnostních důvodů		Zkrácení prvku		Funkční poškození — <b>není dovoleno</b> vydávat materiál z bezpečnostních důvodů
	Oprava dle instrukcí		Označení prvku barvou		Statické poškození — <b>není dovoleno</b> vydávat materiál z bezpečnostních důvodů
	Oprava za studena — poté kontrola svárů a sousedních dílů		Výměna poškozeného dílu		
	Oprava po výpočtu hospodárnosti		Doplnění chybějícího dílu		
	Očištění materiálu				