

PERI Nájemní kritéria

Stabilizace



Kontakt

PERI, spol. s r.o.
bednění lešení služby

Průmyslová 392
252 42 Jesenice u Prahy
tel.: 222 359 311
info@peri.cz
www.peri.cz

Obsah	Strana	Poslední změny	Datum Iniciály	Strana
Stabilizátory RS	2	Nová verze	08/2016 I fw	
Stabilizátor RS 1400	6			
Stabilizátor RSS	11			
Výložník AV	15			
Patky	18			
Hlavy	20			
Hlava pro stabilizátor Trio	26			
Úchyt pro stabilizátor	27			
Vysvětlivky	32			

PERI Nájemní kritéria

Stabilizace



Stabilizátor RS	Č.	Popis	Číslo výrobku
-----------------	----	-------	---------------

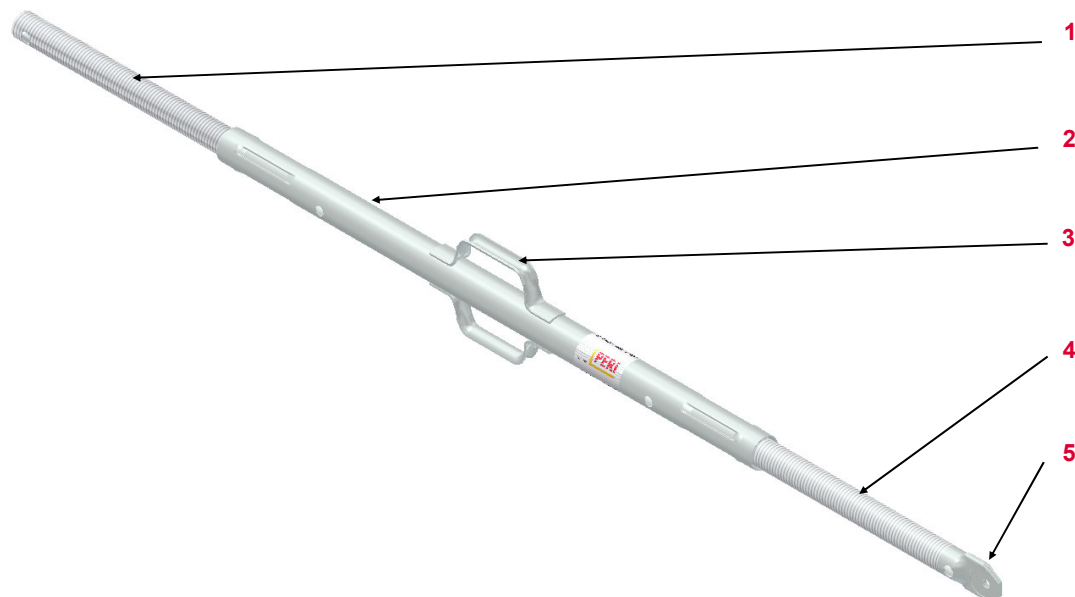

- | | |
|---|------------------------|
| 1 | Vřeteno levé |
| 2 | Vnější trubka |
| 3 | Rukojeť |
| 4 | Vřeteno pravé |
| 5 | Koncovka stabilizátoru |

Platné pro	Číslo výrobku
Push- Pull Prop RS 210	117466
Push- Pull Prop RS 260	118238
Push- Pull Prop RS 300	117467
Push- Pull Prop RS 450	117468
Push- Pull Prop RS 650	117469
Push- Pull Prop RS 1000	028990

PERI Nájemní kritéria

Stabilizace

















Stabilizátor RS	Popis	Instrukce	Fakturace	Typ	
	10.01 Rukojeť				
	<ul style="list-style-type: none"> ■ Ohnutá 			088244	
	<ul style="list-style-type: none"> ■ Nepoužitelná 				
<ul style="list-style-type: none"> ■ Prasklina ve sváru 					
	10.02 Vřeteno				
	<ul style="list-style-type: none"> ■ Velmi znečištěné 		Poté namazat mazivem		
	<ul style="list-style-type: none"> ■ Ohnuté 			Tab. str. 5	
<ul style="list-style-type: none"> ■ Vřeteno nepoužitelné 			Tab. str. 5		

PERI Nájemní kritéria

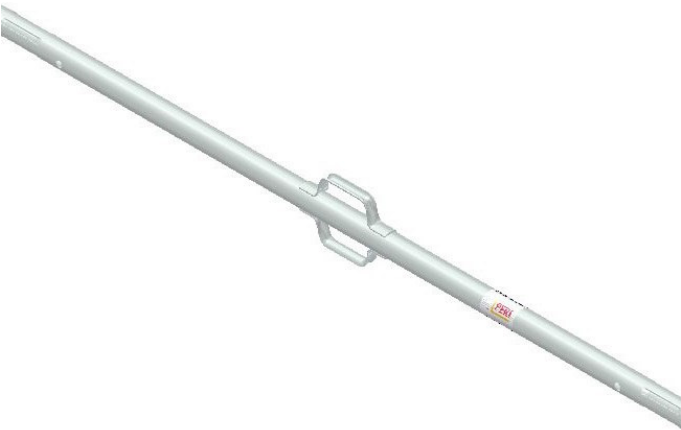
Stabilizace



Stabilizátor RS	Popis	Instrukce	Fakturace	Typ									
	10.03 Ohnuté koncovka stabilizátoru <ul style="list-style-type: none"> ■ Je možné srovnat 		 088244										
	<ul style="list-style-type: none"> ■ Není možné srovnat 		 Tab. str. 5										
	<ul style="list-style-type: none"> ■ Prasklina v profilu 		 Tab. str. 5										
	10.04 Vnější trubka <ul style="list-style-type: none"> ■ Promáčknutí > Ø 3 cm ■ Nefunkční ■ Ohnutý > (L/500) 	 											
	<table border="1"> <thead> <tr> <th>Délka</th> <th>Povolený průhyb</th> </tr> </thead> <tbody> <tr> <td>RS 210, 260; 300</td> <td>4,0mm</td> </tr> <tr> <td>RS 450</td> <td>5,0 mm</td> </tr> <tr> <td>RS 650</td> <td>7,5 mm</td> </tr> <tr> <td>RS 1000</td> <td>12,0 mm</td> </tr> </tbody> </table>	Délka	Povolený průhyb	RS 210, 260; 300	4,0mm	RS 450	5,0 mm	RS 650	7,5 mm	RS 1000	12,0 mm		
Délka	Povolený průhyb												
RS 210, 260; 300	4,0mm												
RS 450	5,0 mm												
RS 650	7,5 mm												
RS 1000	12,0 mm												

PERI Nájemní kritéria

Stabilizace



Servisní artikl	Číslo výrobku nahradního dílu	Číslo opravného artiklu
Výměna vřetena 643	117655	088143
Výměna vřetena 705,5	117650	088144
Výměna vřetena 400	117687	088139
Výměna vřetena 462	117682	088142

PERI Nájemní kritéria

Stabilizace



Stabilizátor RS 1400 (103800)	Č.	Popis	Číslo výrobku
-------------------------------	----	-------	---------------

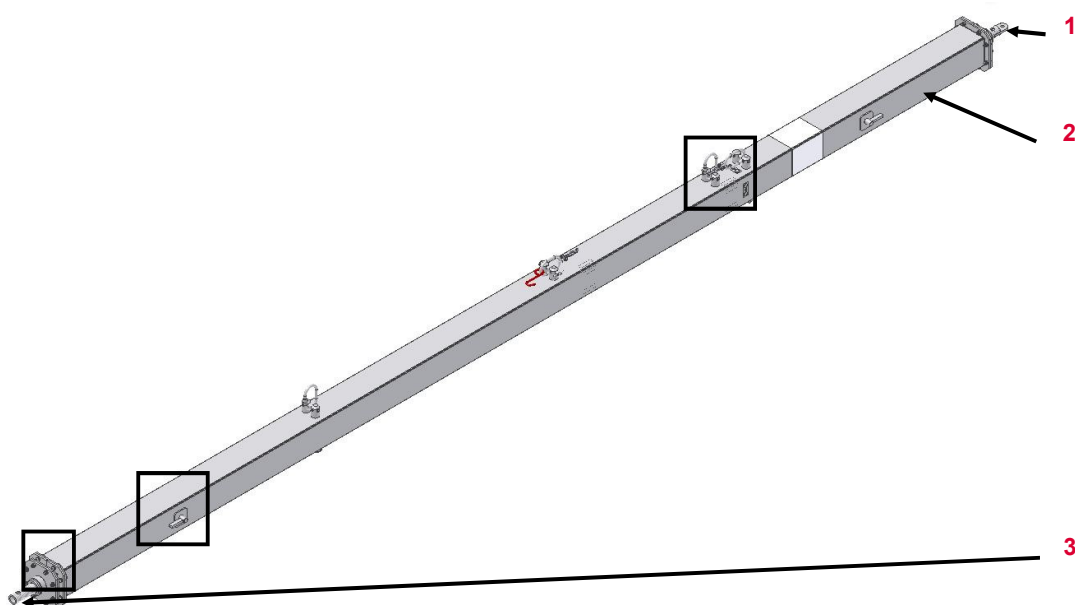



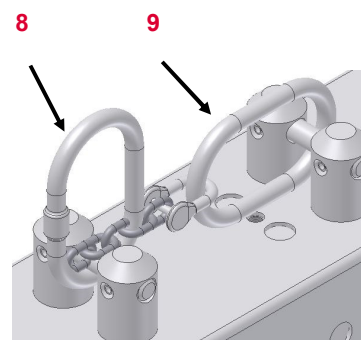
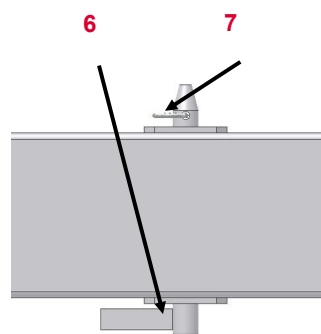
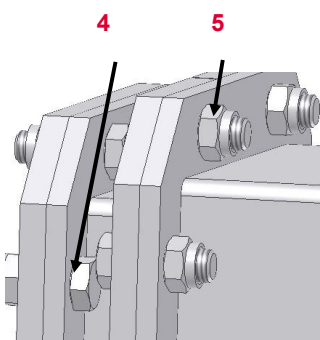









1	Hlava s vřetenem	104242
2	Vnější trubka	
3	Patka s vřetenem	104238
4	Šroub M 12x35	780156
5	Matice M 12	710381
6	Čep	104224
7	Závlačka 4/1	018060
8	Závěsné oko	710671
9	Řetěz RS 1400	104244



PERI Nájemní kritéria

Stabilizace





Stabilizátor RS 1400	Popis	Instrukce	Fakturace	Typ
	10.05 Řetěz			
	■ Chybějící	 104244 (Řetěz) 722441 (Závěsné oko)	 088134	
	■ Nepoužitelný	 104244 (Řetěz) 722441 (Závěsné oko)	 088134	
	<hr/>			
	10.06 Čep			
	■ Chybějící	 104244 (Čep) 018060 (Závlačka)	 088178	
	■ Nepoužitelný	 104244 (Čep) 018060 (Závlačka)	 088178	

PERI Nájemní kritéria

Stabilizace

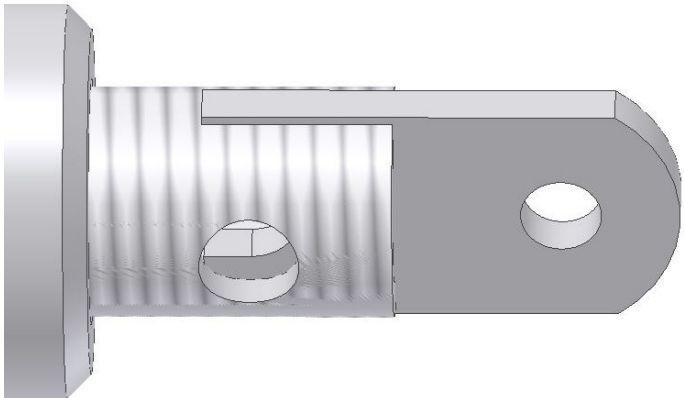

Stabilizátor RS 1400	Popis	Instrukce	Fakturace	Typ	
	10.07 Ohnutá koncovka				
	■ Je možné srovnat		088244		
	■ Není možné srovnat		088137		
	10.08 Vřeteno				
	■ Velmi znečištěno		Poté namazat mazivem		
	■ Nepohyblivé		104246 104239 (Patka s vřetenem)	088137 088126	
	■ Ohnuté		104246 104239 (Patka s vřetenem)	088137 088126	

PERI Nájemní kritéria

Stabilizace



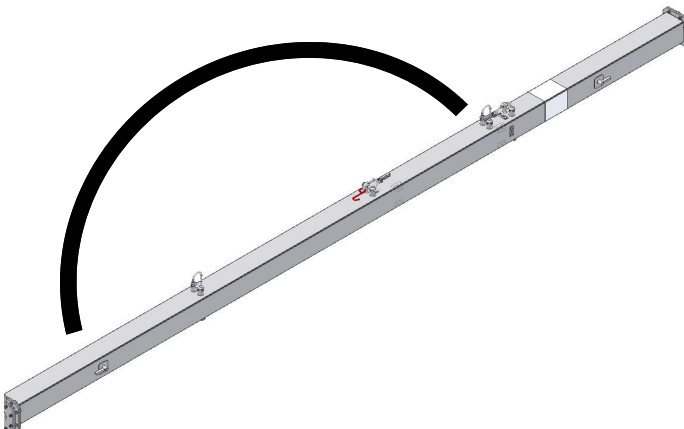
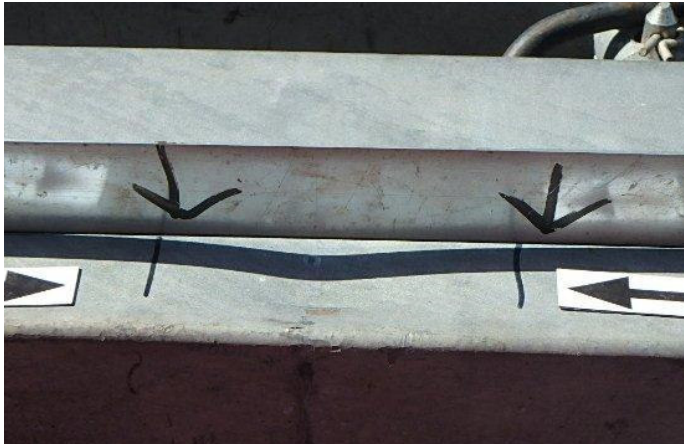











Stabilizátor RS 1400	Popis	Instrukce	Fakturace	Typ
	10.09 Vnější trubka ohnutá <ul style="list-style-type: none"> ■ ≤ 1 cm ■ > 1 cm 	<ul style="list-style-type: none"> ✓ ✖ ✎ 	<ul style="list-style-type: none"> ✎ ☰ 	<ul style="list-style-type: none"> 👁️ ⚠️
	10.10 Promáčknutí na vnější trubce <ul style="list-style-type: none"> ■ ≤ 5 mm ■ > 5 mm ■ Promáčklá hrana 	<ul style="list-style-type: none"> ✓ ✖ ✎ ✖ ✎ 	<ul style="list-style-type: none"> ✎ ☰ ☰ 	<ul style="list-style-type: none"> 👁️ ⚠️ ⚠️

PERI Nájemní kritéria

Stabilizace



Stabilizátor RS 1400	Popis	Instrukce	Fakturace	Typ	
	10.11 Teleskopická trubka	<ul style="list-style-type: none"> ■ Nefunkční 	 104214 (levá) 104251 (pravá)	 088149 088148	
	10.12 Zdeformovaný otvor	<ul style="list-style-type: none"> ■ Vložení čepu je možné 			
	<ul style="list-style-type: none"> ■ Není možné srovnat 	 104214 (levá) 104251 (pravá)	 088149 088148		
	<ul style="list-style-type: none"> ■ Pracklina 	 104214 (levá) 104251 (pravá)	 088149 088148		

PERI Nájemní kritéria

Stabilizace



Stabilizátor RSS	Č.	Popis	Číslo výrobku
------------------	----	-------	---------------

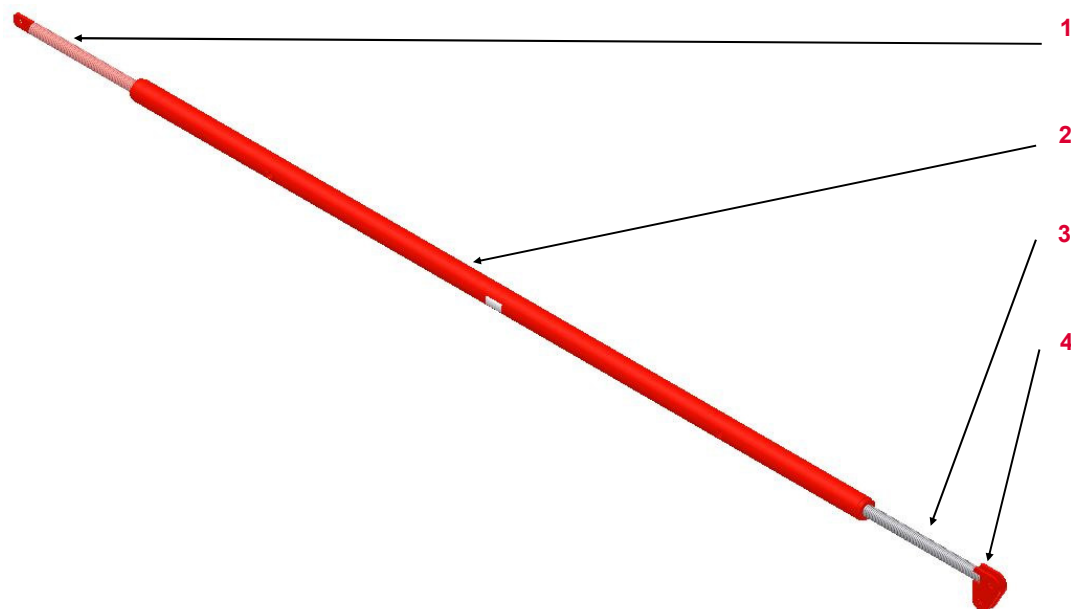





















1	Vřeteno levé
2	Vnější trubka
3	Vřeteno pravé
4	Koncovka stabilizátoru

Platné pro	Číslo výrobku
Stabilizátor RSS	028010
Stabilizátor RSS	028020
Stabilizátor RSS	028030

PERI Nájemní kritéria

Stabilizace



Stabilizátor RSS	Popis	Instrukce	Fakturace	Typ
	10.13 Koncovka ohnutá			
	■ ≤ 5 mm		 088244	
	■ > 5 mm	 		
	■ Prasklina ve sváru	 		
	10.14 Koncovka ohnutá			
	■ Je možné srovnat		 088244	
	■ Není možné srovnat	 		

PERI Nájemní kritéria

Stabilizace









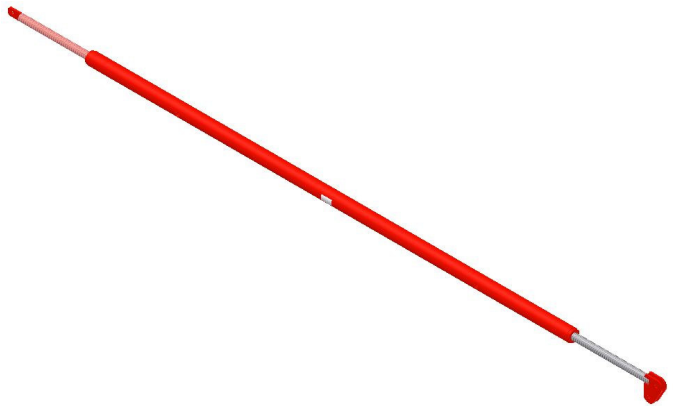

Stabilizátor RSS	Popis	Instrukce	Fakturace	Typ	
	10.15 Závít				
	■ Znečištěno		Poté namazat mazivem		
	■ Ohnutý > 5 mm				
	■ Nepoužitelný				
	10.16 Rukojeť (RSS)				
	■ Ohnutá				
	■ Prasklá				

PERI Nájemní kritéria

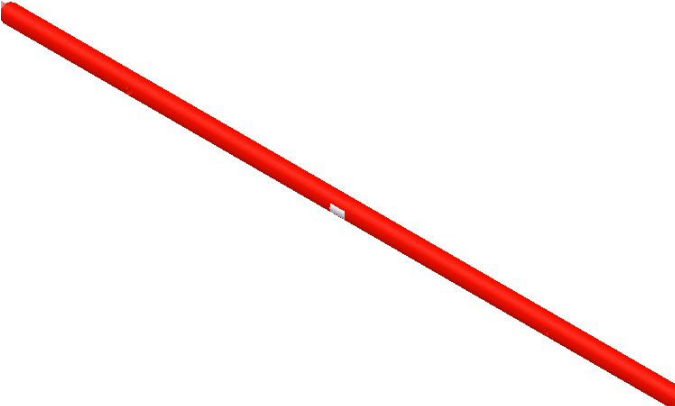
Stabilizace



Stabilizátor RSS	Popis	Instrukce	Fakturace	Typ
	10.17 Ohnutý ■ > 1 cm	 		
	10.18 Promáčknutí Excentrický ■ t > 5 mm	 		

PERI Nájemní kritéria

Stabilizace



Výložník AV	Č.	Popis	Číslo výrobku
-------------	----	-------	---------------

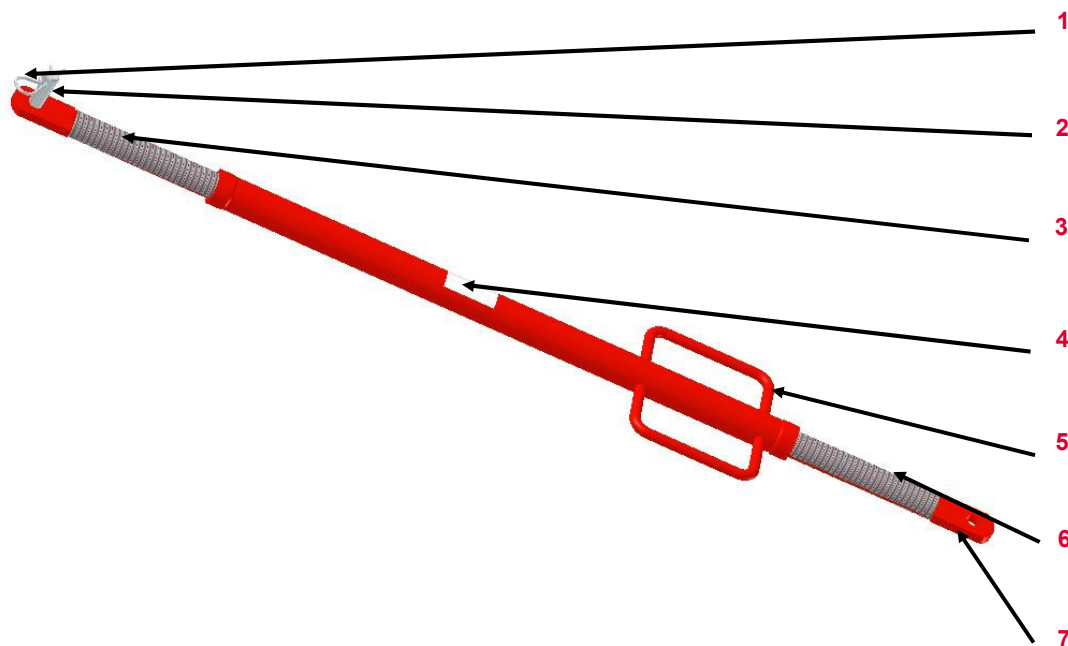



1	Závlačka 4/1	018060
2	Čep Ø 16 mm	027170
3	Vřeteno pravé	
4	Vnější trubka	
5	Rukojeť	
6	Vřeteno levé	
7	Koncovka stabilizátoru	

Platné pro	Číslo výrobku
Výložník AV 82	057087
Výložník AV 111	057088
Výložník AV 140	028110
Výložník AV 210	108135
Výložník AV RSS	028120

PERI Nájemní kritéria

Stabilizace





Výložník AV	Popis	Instrukce	Fakturace	Typ
	10.19 Koncovka stabilizátoru ohnutá			
	<ul style="list-style-type: none"> ■ ≤ 5 mm 		088244	
	<ul style="list-style-type: none"> ■ > 5 mm 			
	<ul style="list-style-type: none"> ■ Prasklina ve sváru 			
	10.20 Vřeteno			
	<ul style="list-style-type: none"> ■ Velmi znečištěno 	Poté namazat mazivem		
	<ul style="list-style-type: none"> ■ Ohnuté > 5 mm 			
	<ul style="list-style-type: none"> ■ Nepoužitelné 			

PERI Nájemní kritéria

Stabilizace



Výložník AV	Popis	Instrukce	Fakturace	Typ
	10.21 Vnější trubka ohnutá			
	<ul style="list-style-type: none"> ■ ≤ 5 mm ■ > 5 mm 	<ul style="list-style-type: none">   	<ul style="list-style-type: none">   	<ul style="list-style-type: none">  
	10.22 Promáčknutí na vnější trubce			
	<ul style="list-style-type: none"> ■ $t \leq 5$ mm ■ $t > 5$ mm 	<ul style="list-style-type: none">   	<ul style="list-style-type: none">   	<ul style="list-style-type: none">  
	<ul style="list-style-type: none"> ■ Excentrické 	<ul style="list-style-type: none">  	<ul style="list-style-type: none">  	<ul style="list-style-type: none"> 

PERI Nájemní kritéria

Stabilizace



Patka RSS (106000)	Č.	Popis	Číslo výrobku
--------------------	----	-------	---------------

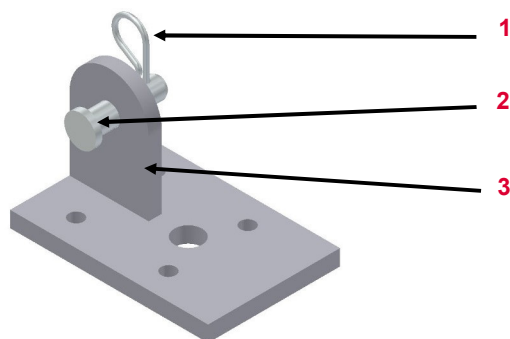

1	Závlačka 4/1	018060
2	Čep Ø 16 x 42	027170
3	Podpěra	

Poškození	Popis	Instrukce	Fakturace	Typ
-----------	-------	-----------	-----------	-----



10.23 Prasklina ve sváru

- bez poškození
- s poškozením

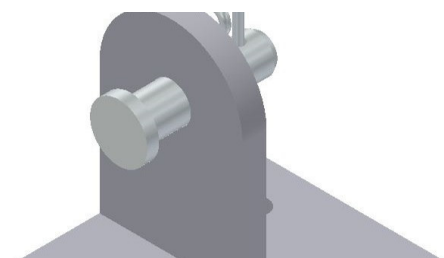

10.24 Podpěra ohnutá

- $\leq 5^\circ$
- $> 5^\circ$



PERI Nájemní kritéria

Stabilizace



Patka (117343)	Č.	Popis	Číslo výrobku
	1	Čep Ø 20 x 140	105400
	2	Šroub M 12 x 80	710220
	3	Matice M 12	710381
	4	Základní deska	
	5	Závlačka 4/1	018060

Poškození	Popis	Instrukce	Fakturace	Typ
	10.25 Základní deska ohnutá ■ Je možné srovnat ■ Není možné srovnat	 	088244 	
	10.26 Čep Závlačka Šroub Chybějící			

PERI Nájemní kritéria

Stabilizace



Hlava na nosník GT 24 (028050)

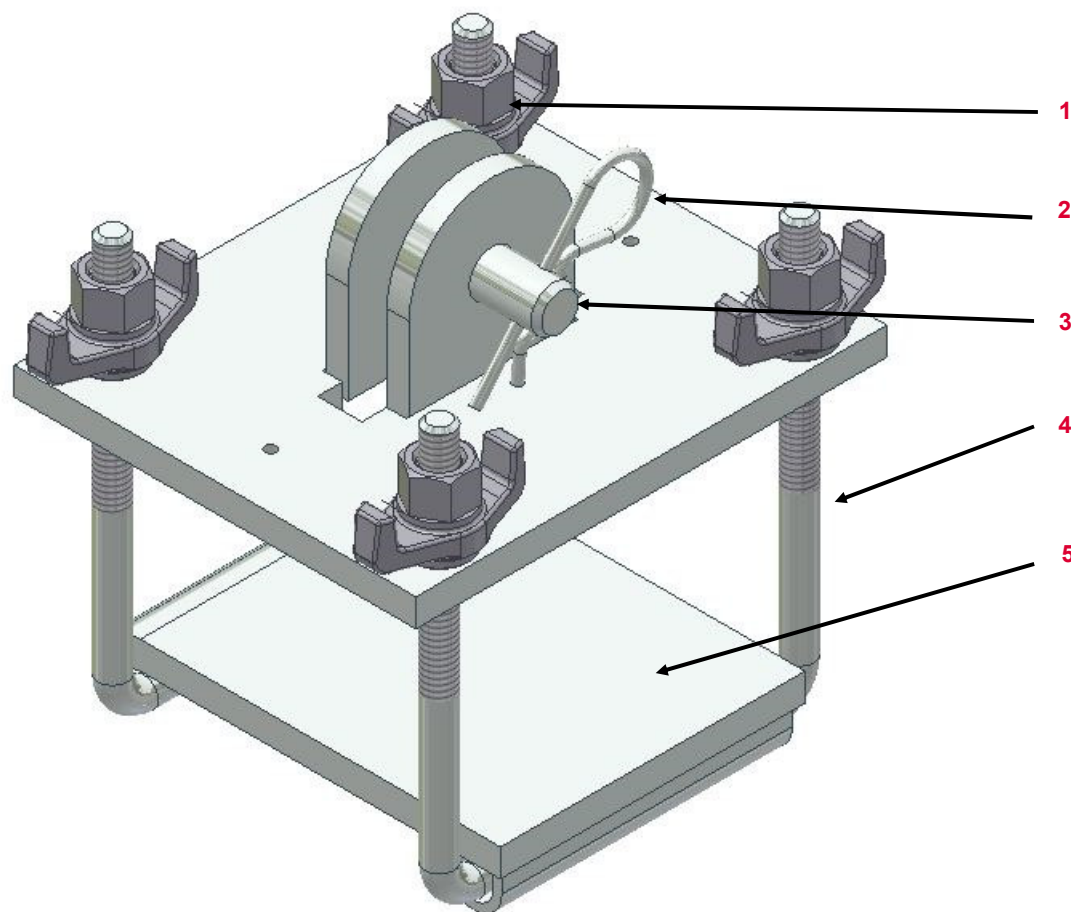









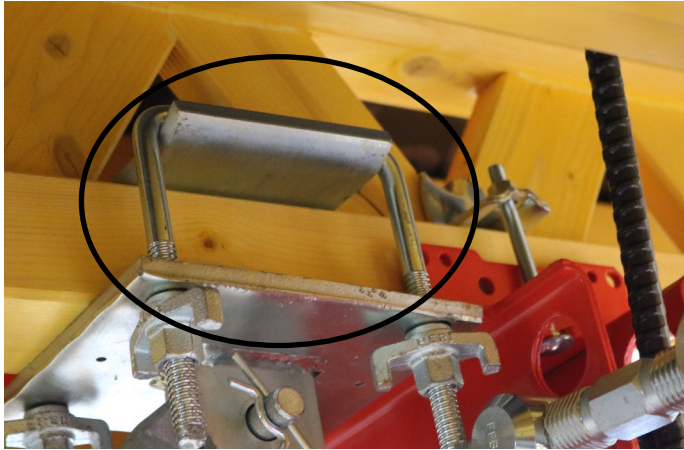

Č.	Popis	Číslo výrobku
1	Matice	710338
2	Závlačka 4/1	018060
3	Čep Ø 16 x 42	027170
4	Upínací třmen	722683
5	Napínací plech	722685

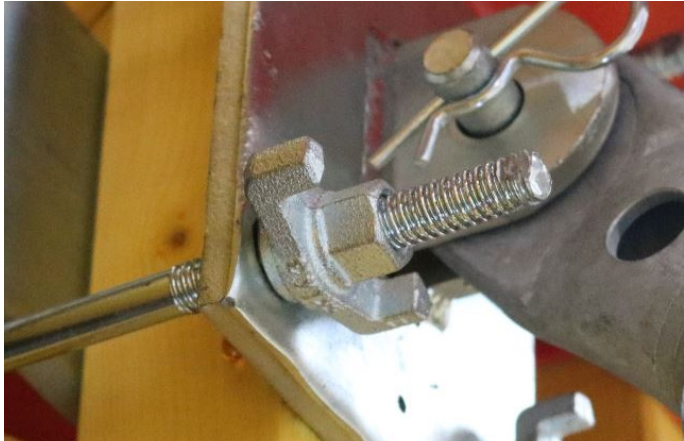
PERI Nájemní kritéria

Stabilizace











Hlava na nosník GT 24	Popis	Instrukce	Fakturace	Typ
	10.27 Upínací třmen Ohnutý uřezaný	 722683 (Upínací třmen)	 088864	
	10.28 Matice <ul style="list-style-type: none"> ■ Chybějící křídlo ■ Chybějící 	 710330 (Matice)	 088862	
		 710330 (Matice)	 088862	

PERI Nájemní kritéria

Stabilizace



Hlava na nosník GT 24	Popis	Instrukce	Fakturace	Typ
	10.29 Napínací plech Ohnutý uřezaný	 722685 (Napínací plech)		
	10.30 Koncovka stabilizátoru ohnutá	<ul style="list-style-type: none"> ■ Je možné srovnat ■ Není možné srovnat 	<div style="display: flex; align-items: center; margin-bottom: 10px;">  <div style="margin-left: 20px;">  088244 </div> </div> <div style="display: flex; align-items: center;">  <div style="margin-left: 20px;">  </div> </div>	<div style="display: flex; align-items: center; margin-bottom: 10px;">  </div> <div style="display: flex; align-items: center;">  </div>

PERI Nájemní kritéria

Stabilizace



Hlava na nosník GT 24/A (028070)

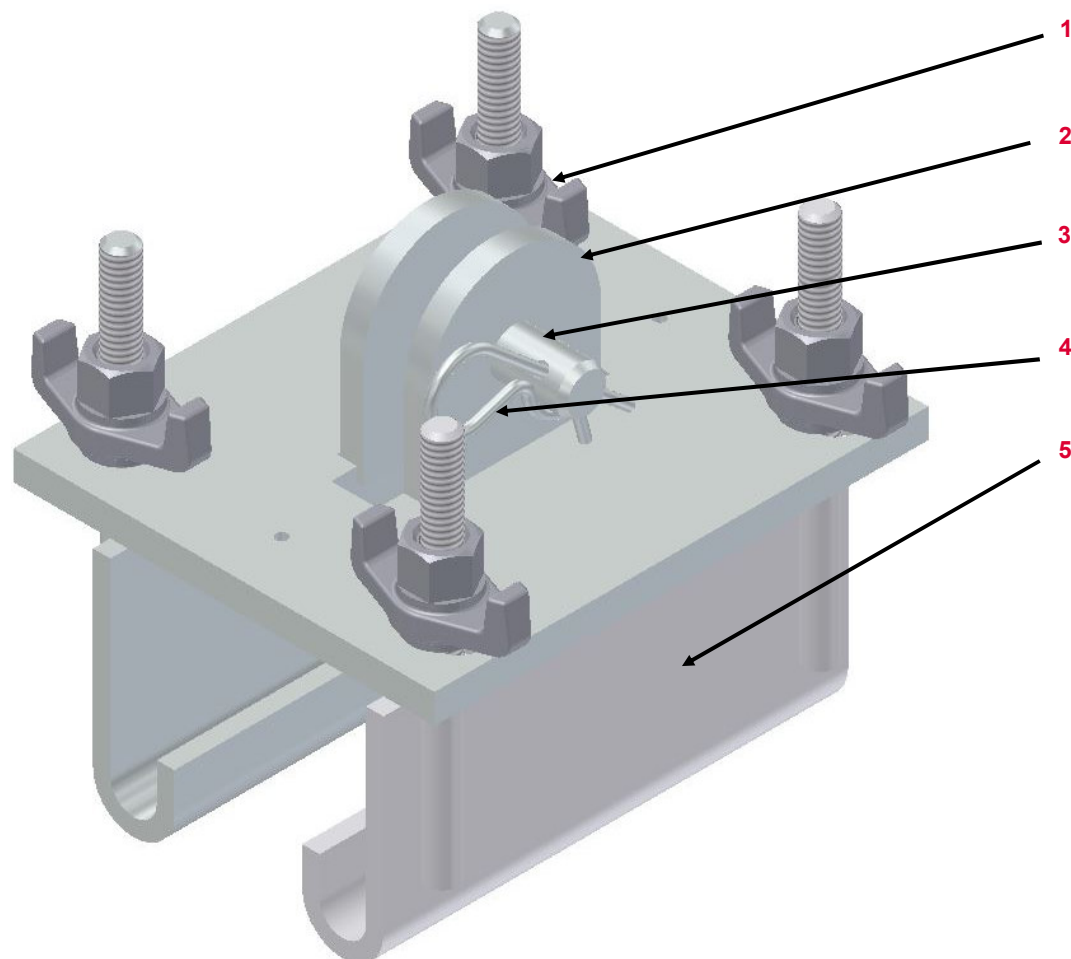









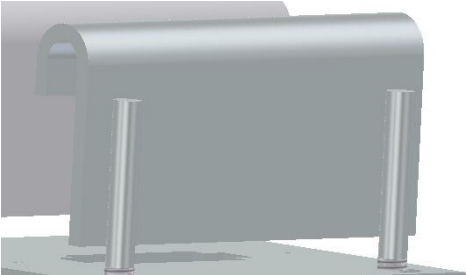









Č.	Popis	Číslo výrobku
1	Matice	710338
2	Koncovka stabilizátoru	
3	Čep Ø 16 x 42	027170
4	Závlačka 4/1	018060
5	Oblouková deska	722735

PERI Nájemní kritéria

Stabilizace



Hlava na nosník GT 24/A	Popis	Instrukce	Fakturace	Typ
	<p>10.31 Oblouková deska ohnutá</p>	<p> 722735 (Oblouková deska)</p>	<p></p>	<p></p>
	<p>10.32 Matice</p> <ul style="list-style-type: none"> ■ Chybějící ■ Prasknuté křídlo 	<p> 710338 (Matice)</p> <p> 710338 (Matice)</p>	<p></p> <p></p>	<p></p> <p></p>
	<p>10.33 Koncovka ohnutá</p> <ul style="list-style-type: none"> ■ Je možné srovnat ■ Není možné srovnat 	<p></p> <p></p>	<p> 088244</p> <p></p>	<p></p> <p></p>

PERI Nájemní kritéria

Stabilizace



Klíňová hlava SRZ/ SRU (028060)	Č.	Popis	Číslo výrobku
---------------------------------	----	-------	---------------

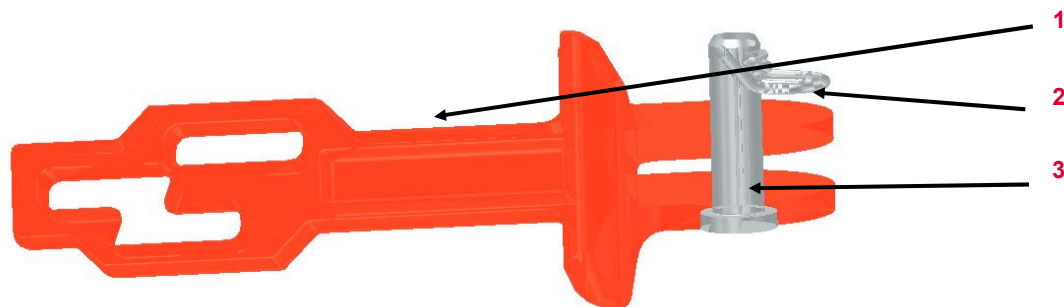

1	Klíňová hlava	
2	Závlačka 4/1	018060
3	Čep Ø 16 x 42	027170

Poškození	Popis	Instrukce	Fakturace	Typ
-----------	-------	-----------	-----------	-----

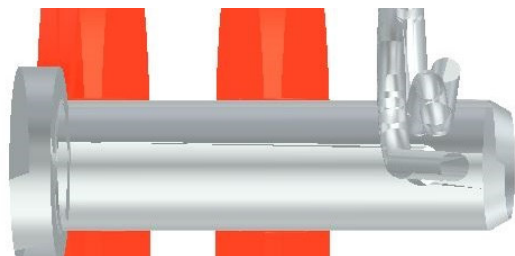

10.34 Čep | Závlačka Chybějící



088192

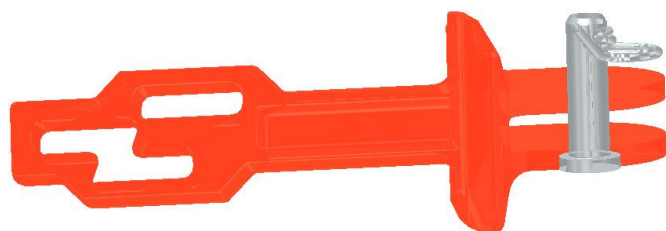













10.35 Ohnutý



PERI Nájemní kritéria

Stabilizace



Hlava pro stabilizátor Trio (023660)	Popis	Instrukce	Fakturace	Typ		
	10.36 Prasklina ve sváru					
	10.37 Ohnutá deformovaná			088244		
	10.38 Poškozené křídlo			030190	088541	

PERI Nájemní kritéria

Stabilizace



Rychlospojka RS (117470)	Č.	Popis	Číslo výrobku
--------------------------	----	-------	---------------

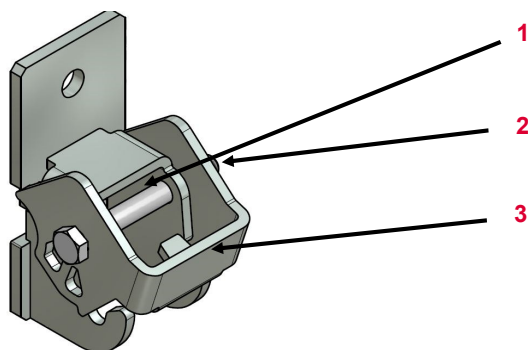

1	Šroub M 16 x 120	710232
2	Matice M 16	070890
3	Pojistka	118084

Poškození	Popis	Instrukce	Fakturace	Typ
-----------	-------	-----------	-----------	-----

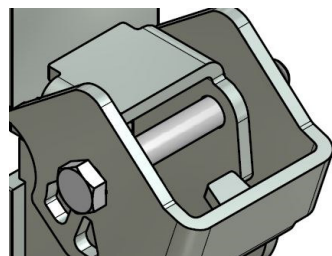

10.41 Pojistka

- Ohnutá
- Nepohyblivá

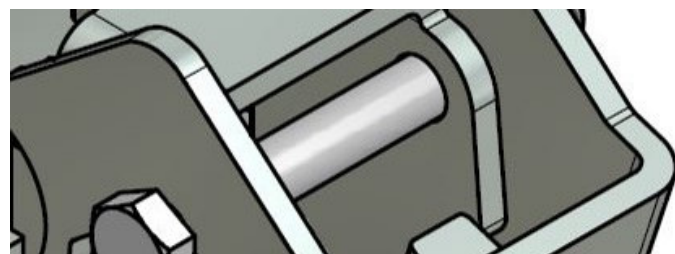

10.42 Čep

- Ohnutý
- Chybějící



PERI Nájemní kritéria

Stabilizace



Úchyt pro stabilizátor 3 (037190)

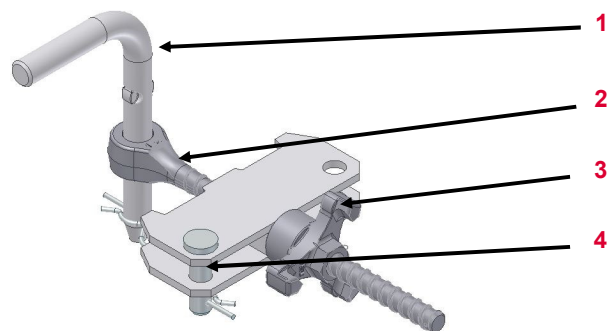

Č.	Popis	Číslo výrobku
1	Rapid pojistný kolík	037160
2	Sloupové táhlo	037150
3	Křídlová matice	030190
4	Čep	027171

Poškození

Popis	Instrukce	Fakturace	Typ
-------	-----------	-----------	-----



10.43 Připojení ohnuté



088244



10.44 Zničená křídlová matice



030190 (Křídlová matice)



088541



PERI Nájemní kritéria

Stabilizace



Úchyt pro stabilizátor QUATTRO (037530)	Č.	Popis	Číslo výrobku
---	----	-------	---------------

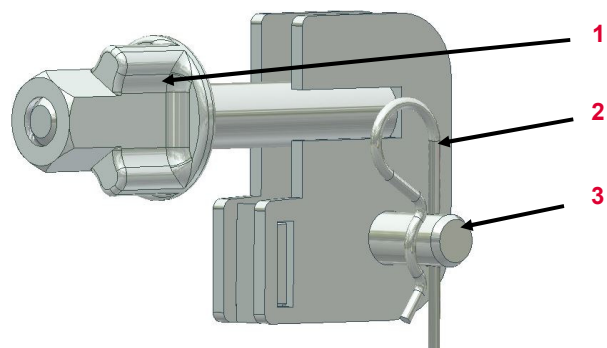

1	Palcová matice	030130
2	Závlačka 4/1	018060
3	Čep	027170

Poškození	Popis	Instrukce	Fakturace	Typ
-----------	-------	-----------	-----------	-----



10.45 Poškozená palcová matice		030130 (Palcová matice)	088429	
--------------------------------	--	--------------------------	--------	--



10.46 Ohnutý				
--------------	--	--	--	--

PERI Nájemní kritéria

Stabilizace



Úchyt pro stabilizátor HDR (022016)

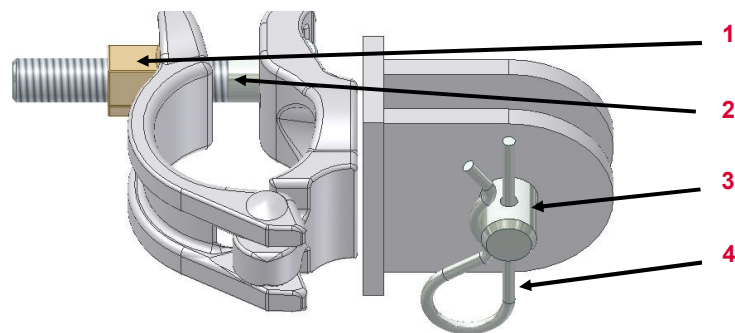

Č.	Popis	Číslo výrobku
1	Matice	710340
2	Šroub s klad. hlavou	710702
3	Čep Ø 16 x 42	027170
4	Závlačka 4/1	018060

Poškození

Popis	Instrukce	Fakturace	Typ
-------	-----------	-----------	-----

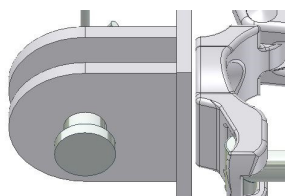

10.47 Koncovka ohnutá



088244

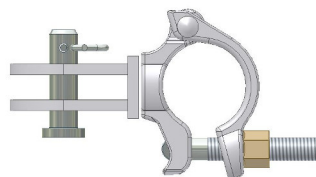

10.48 Spojka ohnutá



PERI Nájemní kritéria

Stabilizace



Patka AV / Stabilizátor (028080)	Č.	Popis	Číslo výrobku
----------------------------------	----	-------	---------------

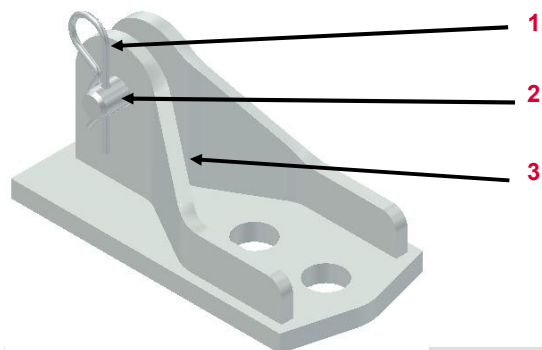

1	Závlačka 4/1	018060
2	Čep Ø 16 x 42	027170
3	Připojovací plech	

Poškození	Popis	Instrukce	Fakturace	Typ
-----------	-------	-----------	-----------	-----

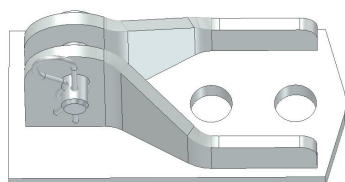

10.51 Připojovací plech ohnutý

- Je možné srovnat
- Není možné srovnat



10.52 Čep | Závlačka chybějící



















088192



PERI Nájemní kritéria

Vysvětlivky znaků



Icon	Significance	Znak	Significance	Znak	Significance
	Není v pořádku – materiál je poškozený		Fakturuje se zákazníkovi		Optické poškození
	OK – materiál zůstává v nájemním skladu		Nefakturuje se zákazníkovi		Funkční poškození
	Poškozený materiál – není dovoleno vydávat materiál z bezpečnostních důvodů		Zkrácení prvku		Funkční poškození — není dovoleno vydávat materiál z bezpečnostních důvodů
	Oprava dle instrukcí		Označení prvku barvou		Statické poškození — není dovoleno vydávat materiál z bezpečnostních důvodů
	Oprava za studena — poté kontrola svárů a sousedních dílů		Výměna poškozeného dílu		
	Oprava po výpočtu hospodárnosti		Doplnění chybějícího dílu		
	Očištění materiálu				