

PERI Nájemní Kritéria

ALPHADECK



Kontakt

PERI, spol. s r.o.
bednění lešení služby
Prumyslová 392
252 42 Jesenice u Prahy
tel.: 222 359 311
info@peri.cz

Obsah	Str.
Panel	2
Padací hlava ADH	7
Nosník ADF	9
Ztužení ADB	11
Příslušenství	14
Vysvětlivky	24

Provedené změny	Datum Iniciály	Str.
Vytvoření kritérií	08/20 fw	



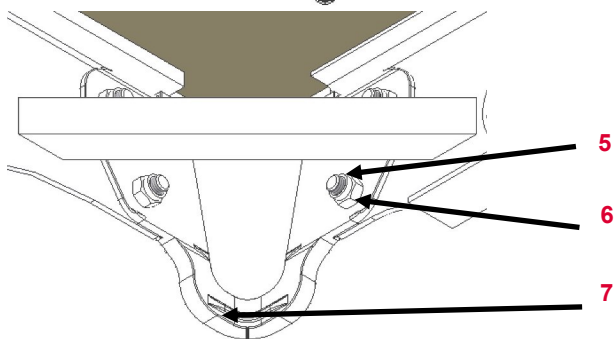
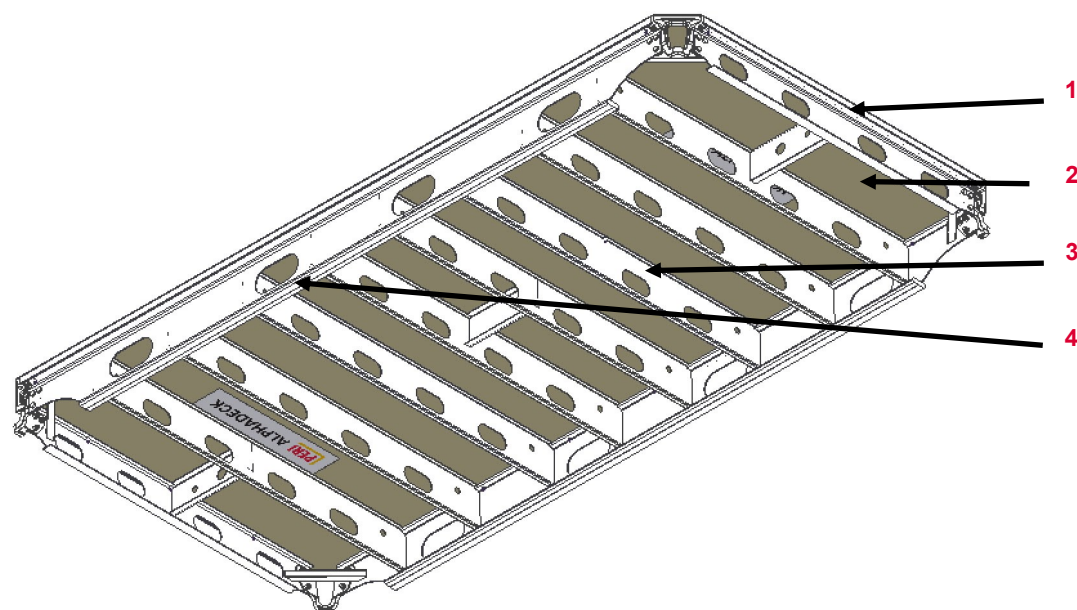

















ALPHADECK Panel



No.	Jméno	Číslo výrobku
1	Rám	
2	Překližka	
3	Žebra	
4	Držadlo	
5	Šroub	722308
6	Matice	711071
7	Rohový přípravek	135171

Platné pro :

















Panel ADP 240x120	135243
Panel ADP 180x120	135178

ALPHADECK Panel	Popis	Instrukce	Fakturace	Typ
	Ohnutý rohový přípravek			
	■ Lze narovnat			
	■ Nelze narovnat		 089404	
	■ Prasklina v rohu		 089404	
	Ohnutý roh v místě s překližkou			
	■ Lze narovnat			
	■ Nelze narovnat		 089404	
	■ Prasklina v rohu		 089404	

PERI Nájemní Kritéria

ALPHADECK











ALPHADECK Panel	Popis	Instrukce	Fakturace	Typ
	Ohnutý profil hrany <ul style="list-style-type: none"> ■ Bez prasklin v materiálu 		 088027	
	<ul style="list-style-type: none"> ■ Prasknutý materiál 	 		
	Ohnuté žebro <ul style="list-style-type: none"> ■ Bez prasklin v materiálu 		 088244	
	<ul style="list-style-type: none"> ■ Prasknutý materiál 	 		

PERI Nájemní Kritéria

ALPHADECK







ALPHADECK Panel	Popis	Instrukce	Fakturace	Typ
	Prasklé držadlo bez ztráty materiálu			
	Prasklé držadlo s vytrženou částí			

PERI Nájemní Kritéria

ALPHADECK



ALPHADECK Panel	Popis	Instrukce	Fakturace	Typ
	Šrouby Matice chybí		 088024	

Padací hlava ADH (134689)

No.	Jméno	Číslo výrobku
-----	-------	---------------

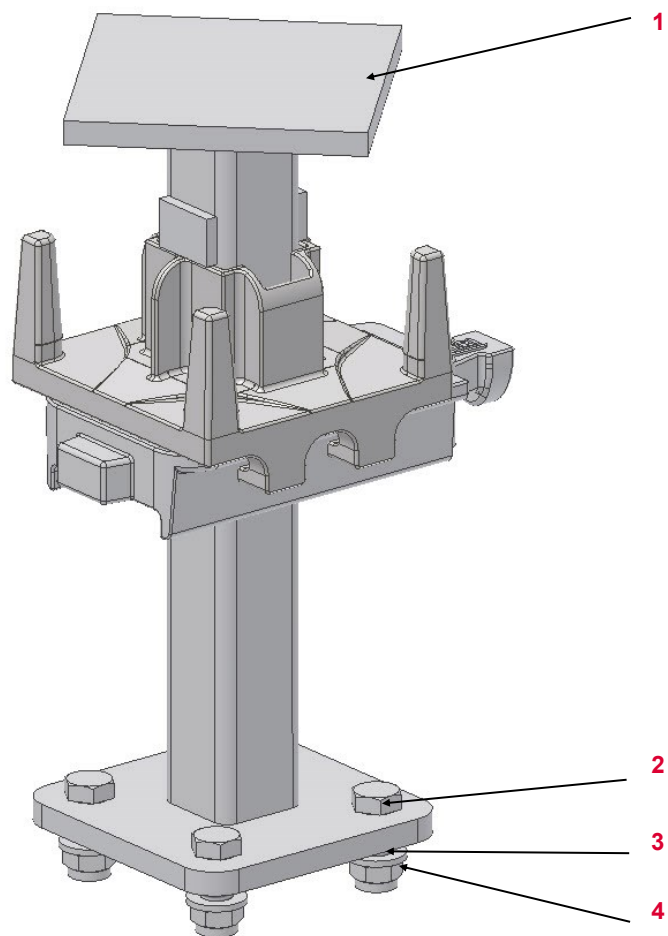

1	Padací hlava ADH	
2	Šroub M12x30	102120
3	Podložka	780702
4	Matice M12	710381

PERI Nájemní Kritéria

ALPHADECK







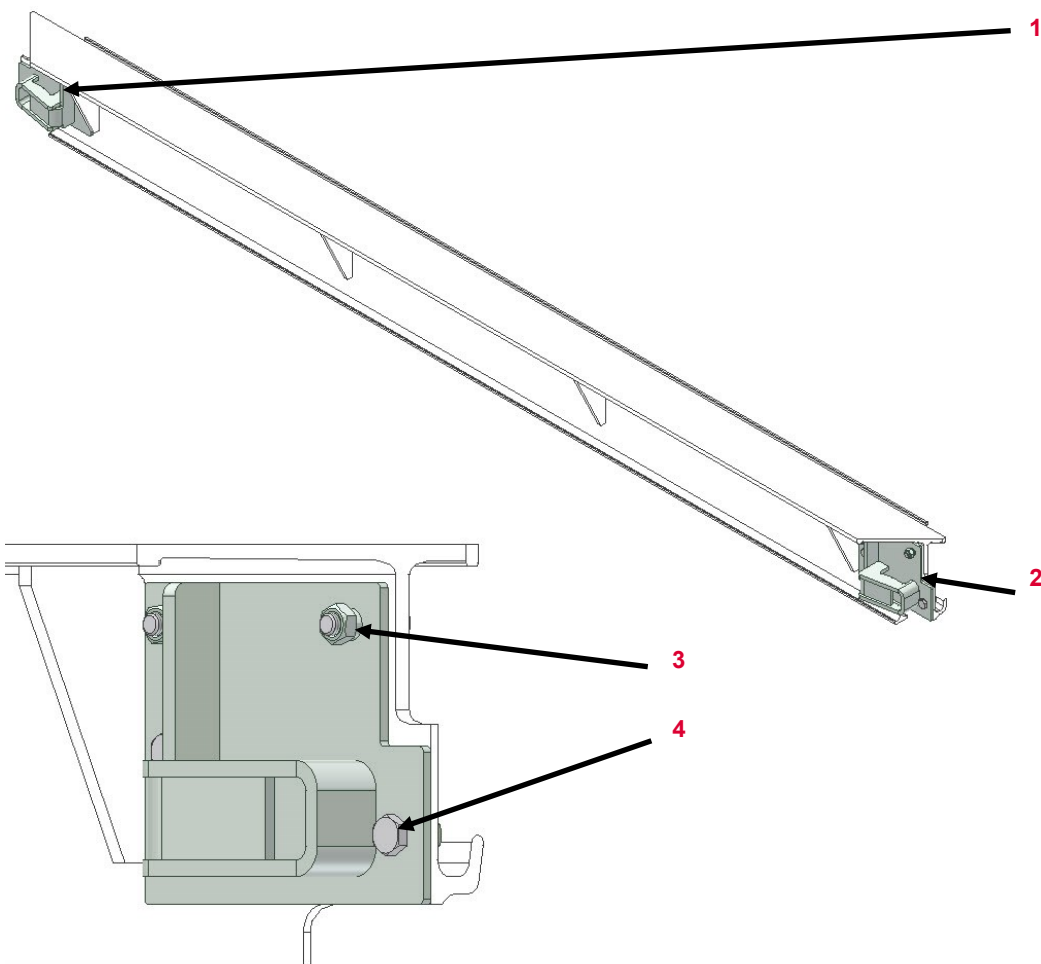



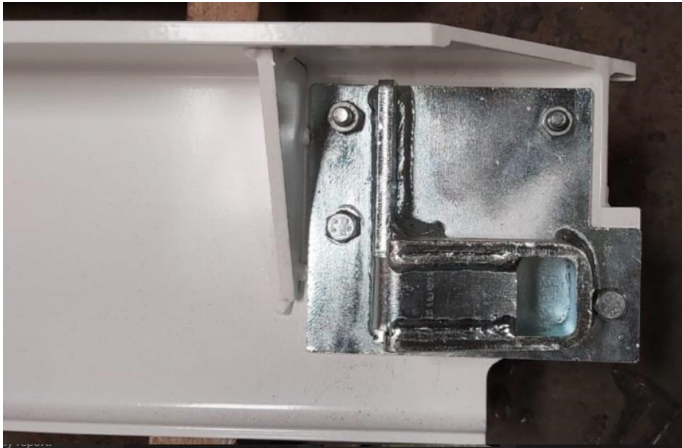





Padací hlava ADH (134689)	Popis	Instrukce	Fakturace	Typ	
	Ohnutí				
	<ul style="list-style-type: none"> ■ Lze narovnat 			088244	
	<ul style="list-style-type: none"> ■ Nelze narovnat 				
<ul style="list-style-type: none"> ■ Praskliny ve výrobku 					
	Šroub Matice Podložka Chybí			088024	

Nosník ADF (135675 | 135671)



No.	Jméno	Číslo výrobku
1	Podpora levá	135658
2	Podpora pravá	135662
3	Matice M8	711071
4	Šroub M8x20	722308

Nosník ADF	Popis	Instrukce	Fakturace	Typ	
	Podpora				
	<ul style="list-style-type: none"> ■ Chybí 			089405	
	<ul style="list-style-type: none"> ■ Poškozená hrubým zacházením 			089405	
	Ohnuté části profilu				
	<ul style="list-style-type: none"> ■ Lze narovnat 			088244	
	<ul style="list-style-type: none"> ■ Nelze narovnat bez zachování funkčnosti výrobku 				



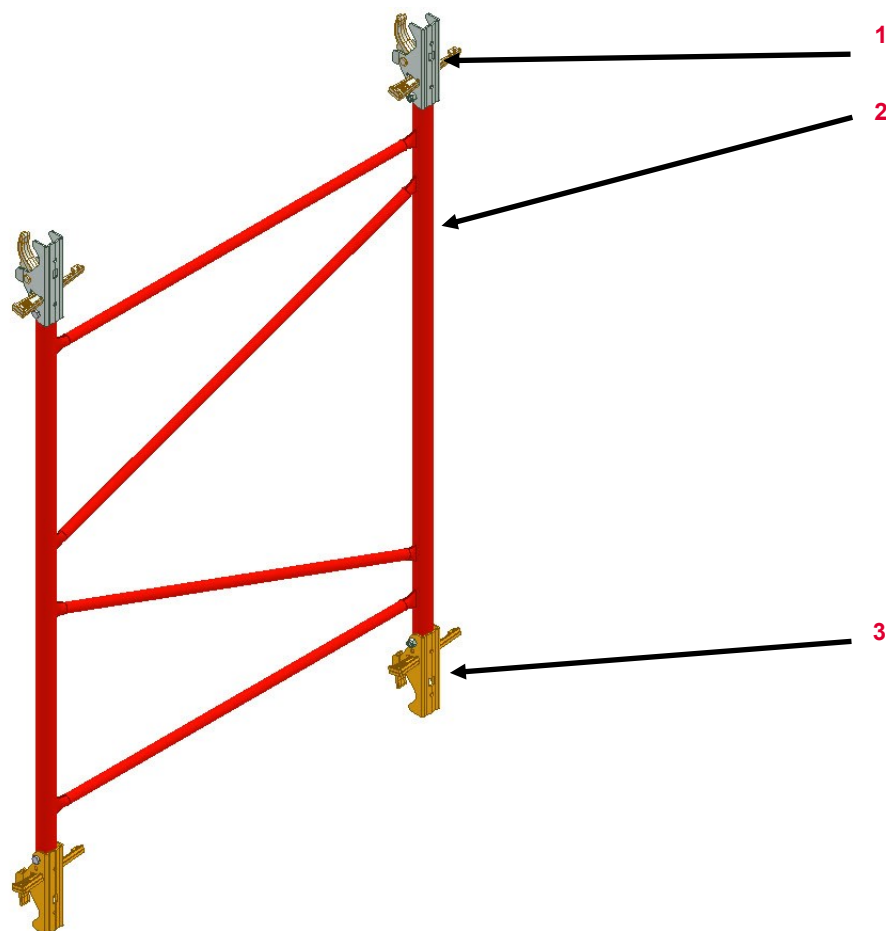







Ztužení ADB



No.	Jméno	Číslo výrobku
1	Úchyt PRK pravý	112206
2	Rám ADP	
3	Úchyt PRK levý	112210

Platné pro:

Ztužení ADB 240	135246
Ztužení ADB 180	135245
Ztužení ADB 120	135244

Ztužení ADB	Popis	Instrukce	Fakturace	Typ
	Nefunkční úchyt <ul style="list-style-type: none"> ■ Opotřebováno ■ Poškozeno silou 	 	  088246	 
		Chybející pružina v úchytu		 088246

Ztužení ADB	Popis	Instrukce	Fakturace	Typ
-------------	-------	-----------	-----------	-----



Prasklý svár

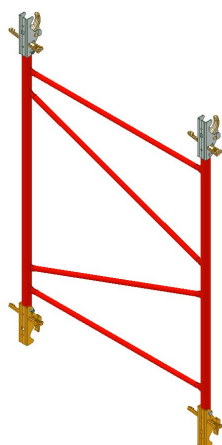

Ohnutý rám

- Lze narovnat
- Nelze narovnat



088244





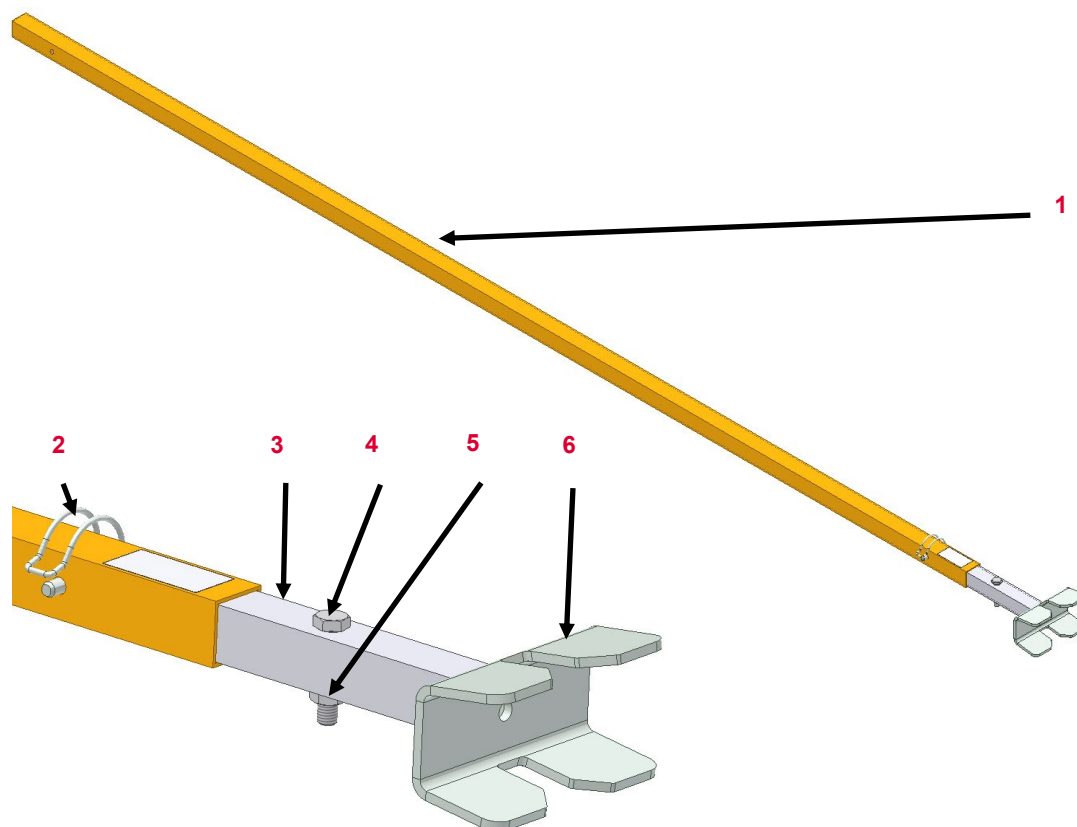





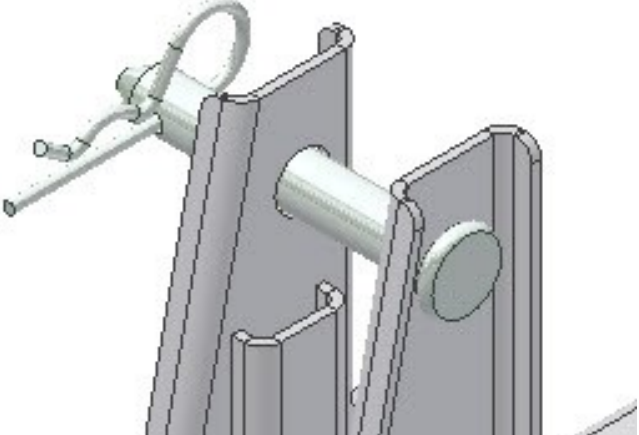







Montážní tyč AD (135615)



No.	Jméno	Číslo výrobku
1	Vnější trubka	135609
2	Trubk. Skl. Klín 8x45	780814
3	Vnitřní trubka	135610
4	Šroub M10x50	710335
5	Matice M10	710234
6	Konzolová hlava	135614

Montážní tyč AD	Popis	Instrukce	Fakturace	Typ
	Části výrobku			
	<ul style="list-style-type: none"> ■ Chybí 			
	<ul style="list-style-type: none"> ■ Poškozené silou 			
			089362	

Držák Zábradlí ADG (135605)	Popis	Instrukce	Fakturace	Typ
	Čep Závlačka			
	<ul style="list-style-type: none"> ■ Chybí ■ Poškozeno silou 	<ul style="list-style-type: none">  018050 (Čep) 018060 (Závlačka)  018050 (Čep) 018060 (Závlačka) 	<ul style="list-style-type: none">  088192  088192 	<ul style="list-style-type: none">  
	Ohnutí			
	<ul style="list-style-type: none"> ■ Lze narovnat 		 088244	
	<ul style="list-style-type: none"> ■ Nelze narovnat 			
<ul style="list-style-type: none"> ■ Nelze vyměnit náhradní díl 				

Paleta AD (135713 |135719)

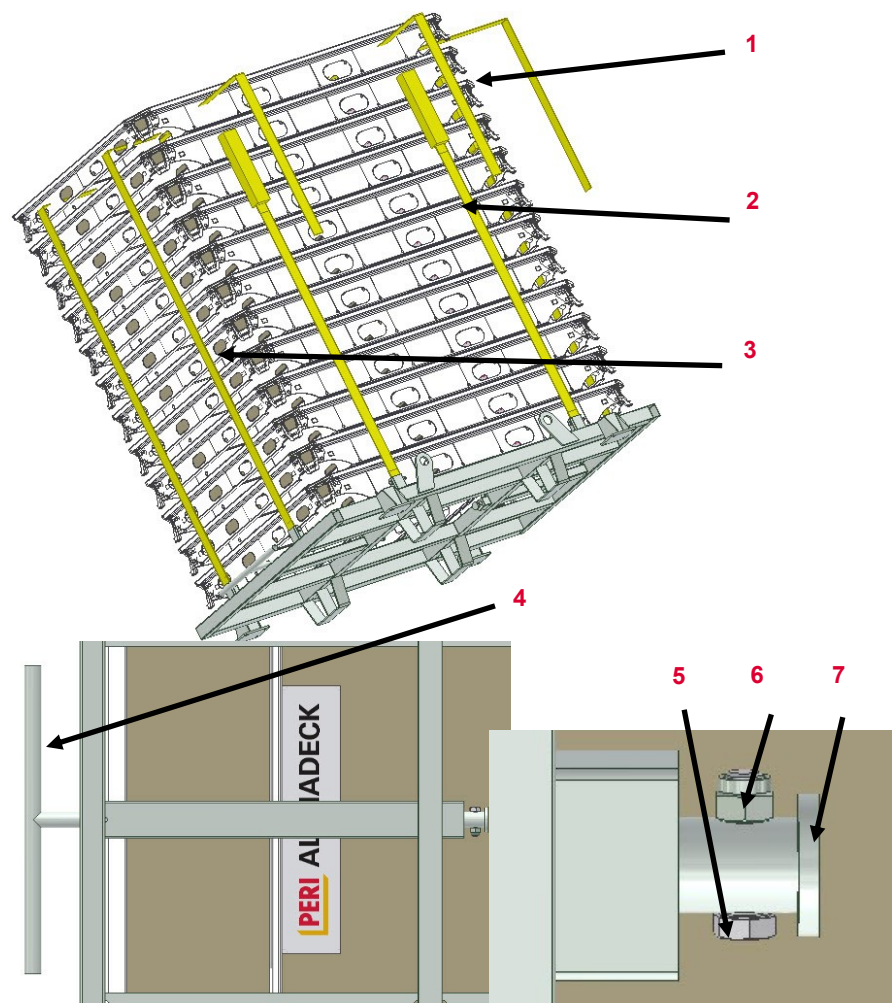



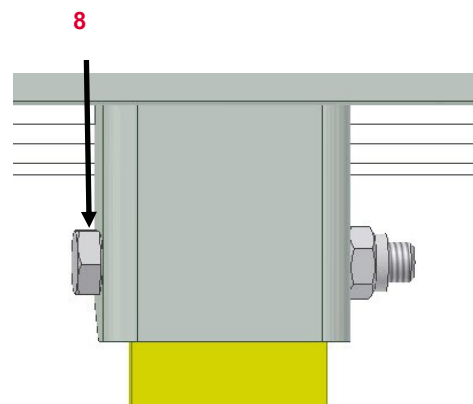







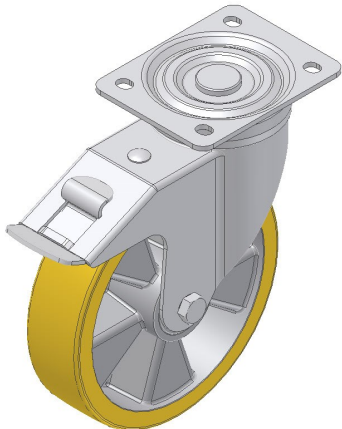

No.	Jméno	Číslo výrobku
1	Pásek volný konec L= 4200 mm	710595
2	Pásek L = 1400 mm	710594
3	Pásek volný konec L= 5000 mm	710596
4	Držadlo	135695
5	Šroub M10x40	710382
6	Matice M10	780356
7	Koncovka držadla	135690
8	Šroub M10x80	710593





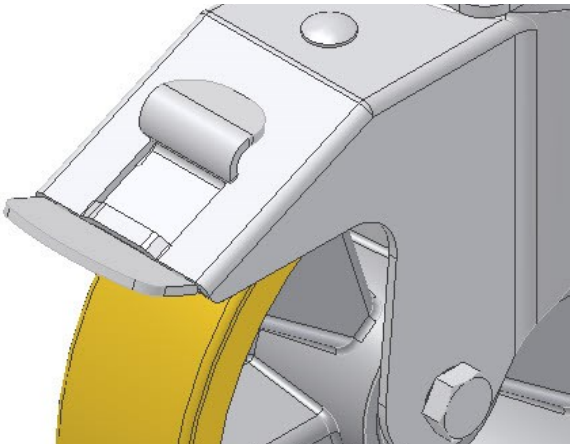





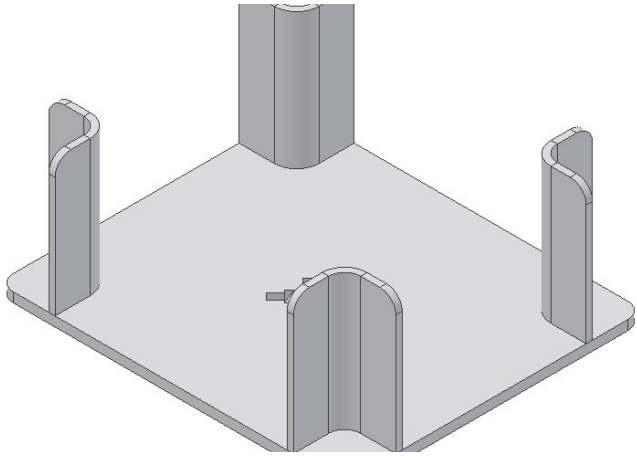







PERI Nájemní Kritéria ALPHADECK

















Paleta AD	Popis	Instrukce	Fakturace	Typ
	Části výrobku			
	<ul style="list-style-type: none"> ■ Chybí 			
	<ul style="list-style-type: none"> ■ Poškozeno silou 			
	<ul style="list-style-type: none"> ■ Ohnuté a nelze vyměnit ■ Praskliny v materiálu svárech 			
	Páska Ráčna			
	<ul style="list-style-type: none"> ■ Opatřebováno 			
	<ul style="list-style-type: none"> ■ Nařízlá nebo uříznutá páska 		 088328 088329 088330 088236 088237	
	<ul style="list-style-type: none"> ■ Nefunkční ráčna 			

Otočné kolečko s brzdou (111690)	Popis	Instrukce	Fakturace	Typ
	Kolečko			
	<ul style="list-style-type: none"> ■ Opotřebováno 	 		
	<ul style="list-style-type: none"> ■ Poškozeno silou 	 		
	Nefunkční brzda			
		 		

Křížová hlava ADC (135653)	Popis	Instrukce	Fakturace	Typ	
	Ohnuté nohy				
	<ul style="list-style-type: none"> ■ Lze narovnat 			088395	
	<ul style="list-style-type: none"> ■ Nelze narovnat 			088394	
<ul style="list-style-type: none"> ■ Chybí 			088394		
	Pojistná klapka				
	<ul style="list-style-type: none"> ■ Chybí 		710017 (Pojistná klapka) 710422 (Upínací vložka 8 x 32)		088898
<ul style="list-style-type: none"> ■ Poškozena silou 		710017 (Pojistná klapka) 710422 (Upínací vložka 8 x 32)		088898	

Napínací řetěz 3,0 KN L = 2,5m (065073)

	Popis	Instrukce	Fakturace	Typ
	Praskliny v řetězu			
	Ohnutý řetěz			
	<ul style="list-style-type: none"> ■ Bez prasklin v řetězu 			
	<ul style="list-style-type: none"> ■ S prasklinami v řetězu 			

Napínací řetěz 3,0 KN L = 2,5m (065073)	Popis	Instrukce	Fakturace	Typ
---	-------	-----------	-----------	-----



Rezavý řetěz

- ≤ Rez třídy C
- Nebo > Rez třídy C



Ohnutý hák

- ≤ 13,5 mm
- Nebo > 16,5 mm



Napínací řetěz 3,0 KN L = 2,5m (065073)	Popis	Instrukce	Fakturace	Typ
---	-------	-----------	-----------	-----

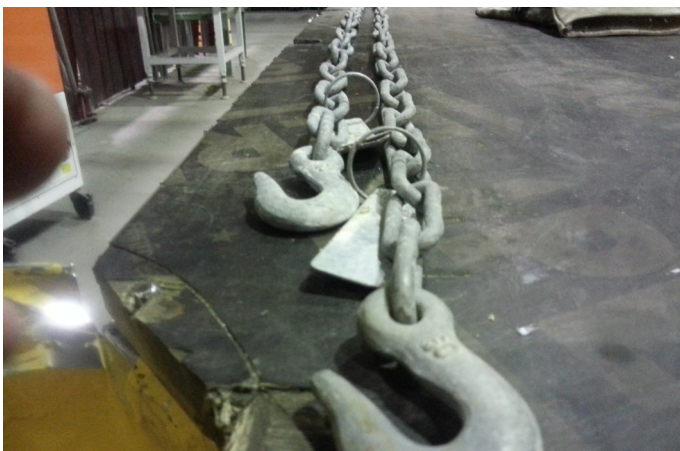

Příliš krátký nebo dlouhý řetěz

■ < 247.5 cm







■ Nebo > 257.0 cm



PERI Nájemní Kritéria

Vysvětlivky znaků



Znak	Význam	Znak	Význam	Znak	Význam
	Není v pořádku – materiál je poškozený		Fakturuje se zákazníkovi		Optické poškození
	OK – materiál zůstává v nájemním skladu		Nefakturuje se zákazníkovi		Funkční poškození
	Poškozený materiál – není dovoleno vydávat materiál z bezpečnostních důvodů		Zkrácení prvku		Funkční poškození — není dovoleno vydávat materiál z bezpečnostních důvodů
	Oprava dle instrukcí		Označení prvku barvou		Statické poškození — není dovoleno vydávat materiál z bezpečnostních důvodů
	Oprava za studena — poté kontrola svárů a sousedních dílů		Výměna poškozeného dílu		
	Oprava po výpočtu hospodárnosti		Doplnění chybějícího dílu		
	Očištění materiálu				