

# PERI Nájemní kritéria

## Průmyslové lešení



### Kontakt

**PERI, spol. s r.o.**  
**bednění lešení služby**  
Průmyslová 392  
252 42 Jesenice u Prahy  
tel.: 222 359 311  
info@peri.cz  
www.peri.cz

Obsah	Strana
Konzoly	2
Čelní zábradlí	6
Podlahová zarážka UPY	12
Podlahová zarážka Dřevěná UPF	14
Průlez z poklopem	16
Příslušenství	19
Vysvětlivky	29

Poslední verze	Datum   Iničiály	Strana
Nová verze	06/2017   fw	
Bezpečnostní dvířka přidány	06/2019   fw	
Hatch UAF-2 and Base Standard VARIOKIT added	07/2021   fw	

### Konzola UCM | UC

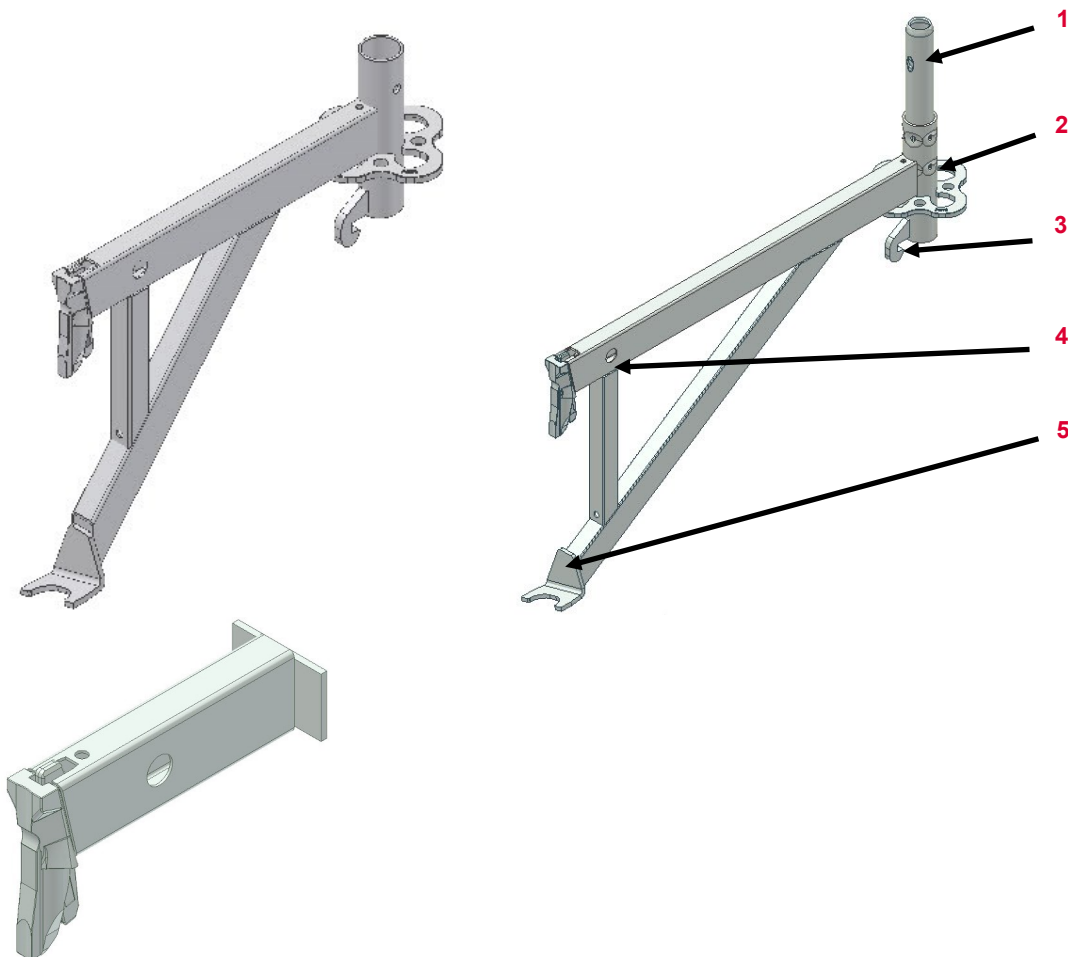

Č.	Popis	Číslo výrobek
----	-------	---------------

- |   |                |  |
|---|----------------|--|
| 1 | Trn            |  |
| 2 | Rosett         |  |
| 3 | Podpěrný háček |  |
| 4 | Klínek UCM     |  |
| 5 | Opěra UCM      |  |



#### Platné pro:

Konzola UCM 50-2	110483
Konzola UCM 75-2	111128
Konzola UCM 50 with Trn	112676
Konzola UCM 75 with Trn	112678
Konzola UCM 50 with Half-Rosett	112690
Konzola UCM 75 with Half-Rosett	112693
KonzolaUC 25	115959
KonzolaUC 33	130390
KonzolaUC 37,5	115962

# PERI Nájemní kritéria

## Průmyslové lešení



























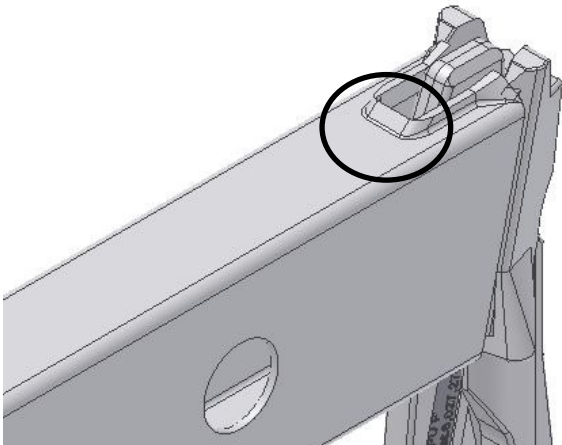













Konzola UCM	Popis	Instrukce	Fakturace	Typ
	<b>33.40.01 Podpěrný háček ohnutý</b>			
	■ Oprava je možná		088244	
	■ Není možná oprava			
	■ Prasklina ve sváru			
	<b>33.40.02 Opěra UCM ohnutá</b>			
	■ Oprava je možná		088244	
	■ Není možná oprava			
	■ Prasklina ve sváru			

# PERI Nájemní kritéria

## Průmyslové lešení



Konzola UCM	Popis	Instrukce	Fakturace	Typ
	<p><b>33.40.03 Rozeta   Půlrozeta ohnutá</b></p> <ul style="list-style-type: none"> <li>■ ≤ 20 mm</li> <li>■ &gt; 20 mm</li> </ul>	<div style="display: flex; flex-direction: column; align-items: center;"> <div style="display: flex; gap: 5px;">   </div> <div style="display: flex; gap: 5px; margin-top: 10px;">   </div> </div>	<div style="display: flex; flex-direction: column; align-items: center;"> <div style="display: flex; gap: 5px;">  <span>088244</span> </div> <div style="display: flex; gap: 5px; margin-top: 10px;">  </div> </div>	<div style="display: flex; flex-direction: column; align-items: center;">   </div>
	<p><b>33.40.04 Vytržená část u klínu   Klínek chybějící</b></p>	<div style="display: flex; gap: 5px;">   </div>	<div style="display: flex; align-items: center;">  </div>	<div style="display: flex; align-items: center;">  </div>

Konzola UCM	Popis	Instrukce	Fakturace	Typ
	<b>33.40.05 Důlky u klínku</b>			
	■ Není poškozená hrana		 088244	
	■ Je poškozená hrana a není možná oprava	 		
	■ Prasklina v materiálu	 		
	<b>33.40.06 Promáčknutý otvor</b>			
	■ Není změněna geometrie		 088244	
	■ Je změněna geometrie	 		
	■ Prasklina v materiálu	 		









# PERI Nájemní kritéria

## Průmyslové lešení



Čelní zábradlí UPA (130476; 130583)	Popis	Instrukce	Fakturace	Typ	
	33.40.07 Trn ohnutý	<ul style="list-style-type: none"> <li>■ Oprava je možná (Trn je možné osadit)</li> </ul>		088244	
	<ul style="list-style-type: none"> <li>■ Není možná oprava</li> </ul>				
	<ul style="list-style-type: none"> <li>■ Prasklina ve sváru nebo materiálu</li> </ul>				
	33.40.08 Ohnutá vidlice	<ul style="list-style-type: none"> <li>■ Oprava je možná</li> </ul>		088244	
	<ul style="list-style-type: none"> <li>■ Není možná oprava</li> </ul>				

Čelní zábradlí (110478; 116691)	Popis	Instrukce	Fakturace	Typ
	<p>33.40.09 Ložisko ohnuté   nepoužitelné</p>	 110565 (Bearing)		
	<p>33.40.10 Trubka ohnutá</p> <ul style="list-style-type: none"> <li>■ Zábradlí nemůže být osazeno</li> </ul>			

Sklopná horizontála UPK (110072)	Popis	Instrukce	Fakturace	Typ
	<p><b>33.40.11 Lokální porušení</b></p> <ul style="list-style-type: none"> <li>■ Hrana není poškozena</li> </ul>			
	<p><b>33.40.12 Vytržená část u klínu   Klínek chybějící</b></p>	 		



Sklopná horizontála UPK (110072)	Popis	Instrukce	Fakturace	Typ
----------------------------------	-------	-----------	-----------	-----



33.40.13 Ohnutý profil na hraně

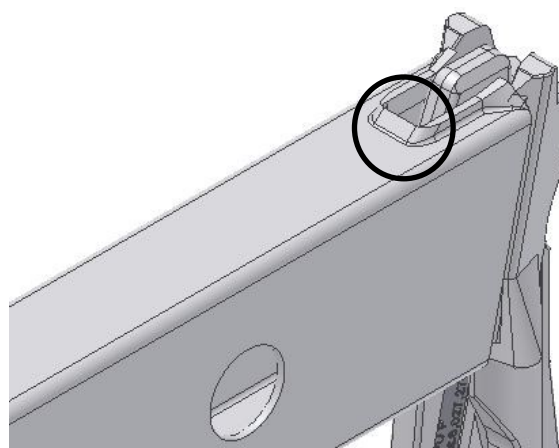











■ 33.40.14 Důlky u klínku







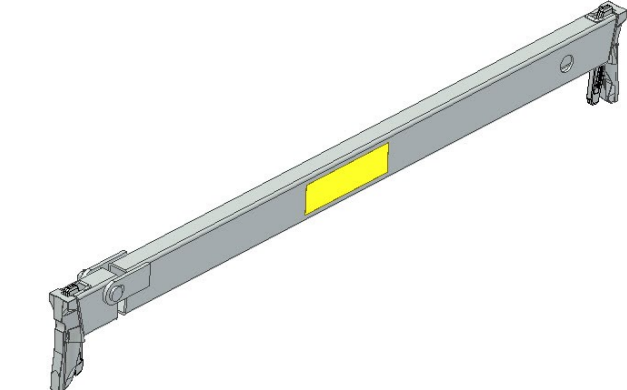

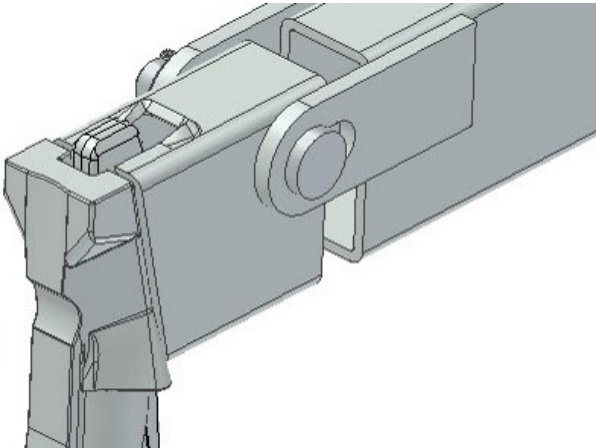

- 
- Není poškozená hrana
- 
- 
- Je poškozená hrana a není možná oprava
- 
- Prasklina v materiálu



088244

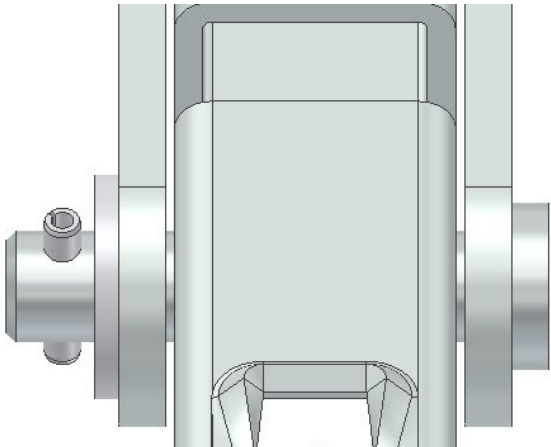

Sklopná horizontála UPK (110072)	Popis	Instrukce	Fakturace	Typ
	<b>33.40.15 Promáčknutý otvor</b>	<ul style="list-style-type: none"> <li>■ Není změněna geometrie</li> </ul>	 088244	
	<ul style="list-style-type: none"> <li>■ Je změněna geometrie</li> </ul>			
	<ul style="list-style-type: none"> <li>■ Prasklina v materiálu</li> </ul>			
	<b>33.40.16 Ohnutý nosník</b>	<ul style="list-style-type: none"> <li>■ Zřetelná deformace</li> </ul>		

Sklopná horizontála UPK (110072)	Popis	Instrukce	Fakturace	Typ
	33.40.17 Koncový spoj			
	■ Chybějící			
■ Poškozený hrubou silou		110075 (Kocový spoj )		
	33.40.18 Chybějící Čep   Kolík   Podložka			
	117451 (Čep) 722930 (Kolík) 780702 (Podložka)			



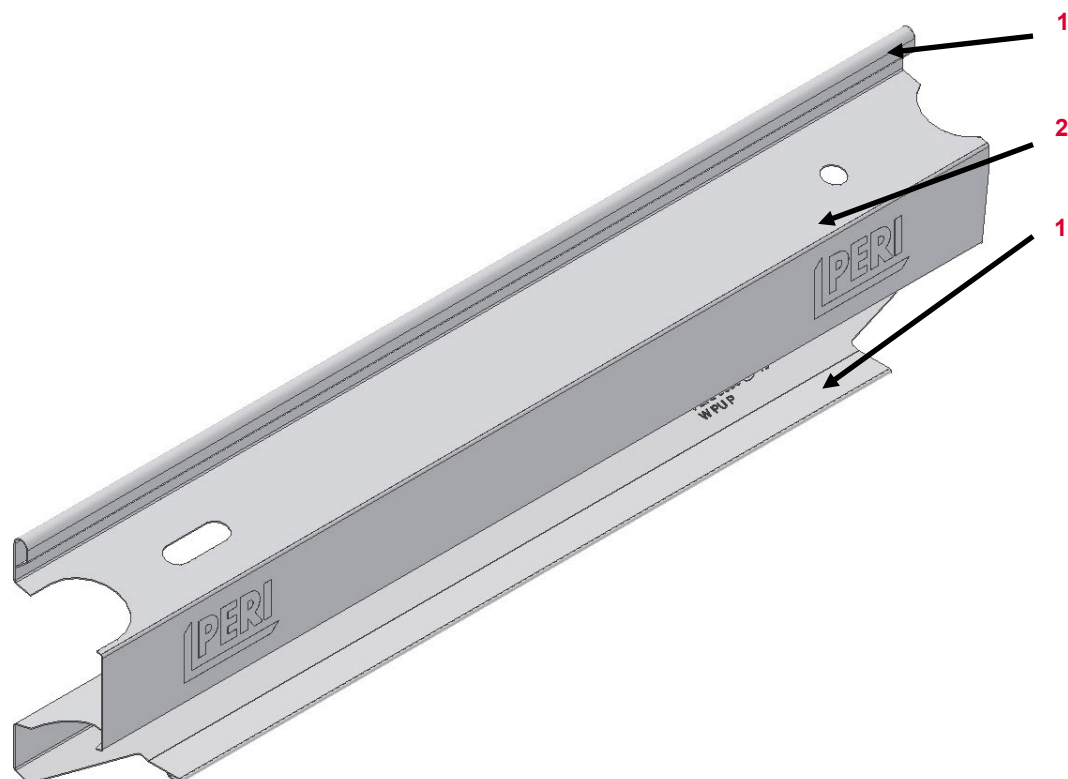















### Podlahová zarážka UPY



Č.	Popis	Číslo výrobek
----	-------	---------------

- |   |                   |  |
|---|-------------------|--|
| 1 | Hrana             |  |
| 2 | Podlahová zarážka |  |

Platné pro:	Číslo výrobku
Podlahová zarážka UPY 50	110213
Podlahová zarážka UPY 67	129947
Podlahová zarážka UPY 72	110526
Podlahová zarážka UPY 75	110514
Podlahová zarážka UPY 100	110073
Podlahová zarážka UPY 104	110076
Podlahová zarážka UPY 150	110160
Podlahová zarážka UPY 200	110176
Podlahová zarážka UPY 250	110208
Podlahová zarážka UPY 300	110211
Podlahová zarážka UPY 50 Galv.	117495
Podlahová zarážka UPY 72 Galv.	117938
Podlahová zarážka UPY 75 Galv.	117518
Podlahová zarážka UPY 100 Galv.	117981
Podlahová zarážka UPY 104 Galv.	123597
Podlahová zarážka UPY 150 Galv.	123694
Podlahová zarážka UPY 200 Galv.	123696
Podlahová zarážka UPY 250 Galv.	123698
Podlahová zarážka UPY 300 Galv.	123700

Podlahová zarážka	Popis	Instrukce	Fakturace	Typ
	<b>33.40.19 Ohnutá hrana</b>			
	<ul style="list-style-type: none"> <li>■ Oprava je možná</li> </ul>		 088244	
	<ul style="list-style-type: none"> <li>■ Není možná oprava</li> </ul>			
	<b>33.40.20 Podlahová zarážka ohnutá</b>			
	<ul style="list-style-type: none"> <li>■ Oprava je možná a ohnutí <math>\leq L/100</math></li> </ul>		 088244	
	<ul style="list-style-type: none"> <li>■ Není možná oprava a ohnutí <math>&gt; L/100</math></li> </ul>			
	<b>33.40.21 Prohlubeň v podlahové zarážce</b>		 088244	

# PERI Nájemní kritéria

## Průmyslové lešení



### Podlahová zarážka Dřevěná UPF

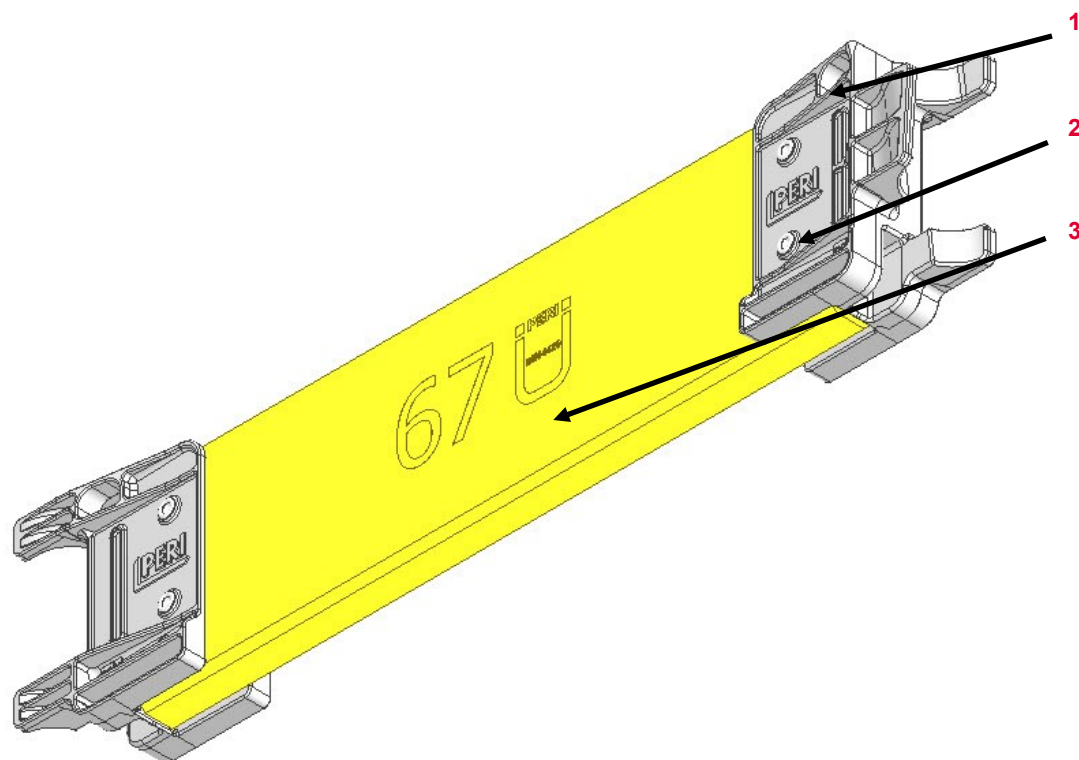









Č.	Popis	Číslo výrobek
1	Koncovka podlahové zarážky	
2	Nýt	
3	Prkno	

Platné pro:	Číslo výrobku
Podlahová zarážka Dřevěná UPF 50	129490
Podlahová zarážka Dřevěná UPF 67	129492
Podlahová zarážka Dřevěná UPF 75	129494
Podlahová zarážka Dřevěná UPF 100	129496
Podlahová zarážka Dřevěná UPF 150	129498
Podlahová zarážka Dřevěná UPF 200	129500
Podlahová zarážka Dřevěná UPF 250	129502
Podlahová zarážka Dřevěná UPF 300	129504

# PERI Nájemní kritéria

## Průmyslové lešení



Podlahová zarážka Dřevěná UPF	Popis	Instrukce	Fakturace	Typ
	<b>33.40.22 Hroty vylomeny</b>			
	<b>33.40.23 Podlahová zarážka</b> Poškozeno hrubou silou			

# PERI Nájemní kritéria

## Průmyslové lešení



### Průřez s poklopem UAF

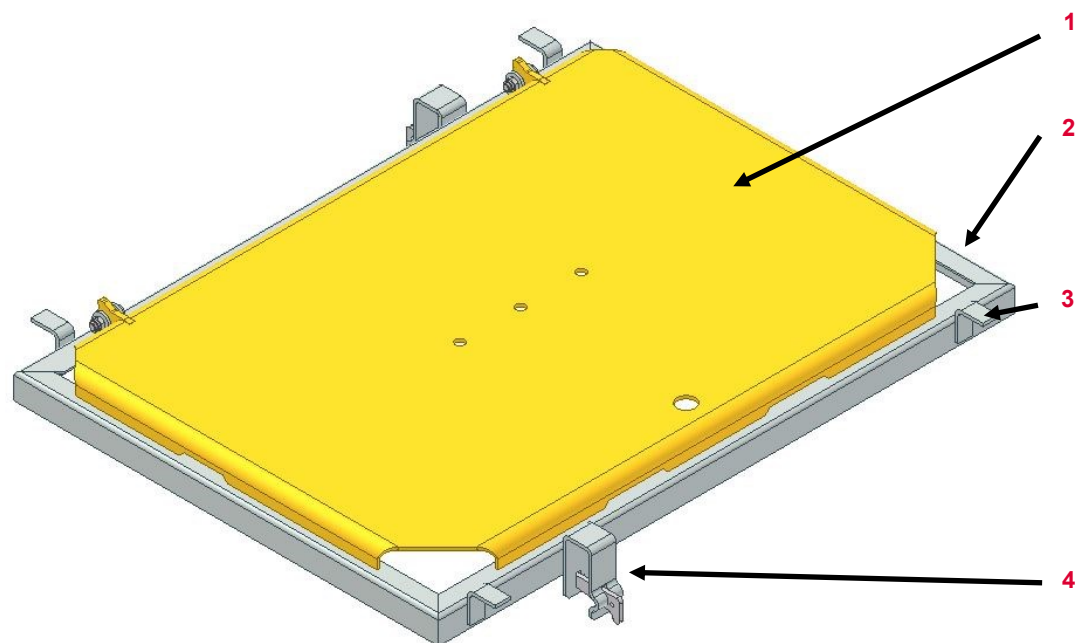

Č.	Popis	Číslo výrobek
1	Poklop	
2	Rám	
3	Hák	
4	Jistící hák	













Platné pro:	Číslo výrobku
Průřez s poklopem UAF 50x75	109783
Průřez s poklopem UAF 75x100	109755
Krycí plech UDP 75	111101
Krycí plech UDP 100	112809
Rohový plech UDC 75	114148
Rohový plech UDC 100	113358





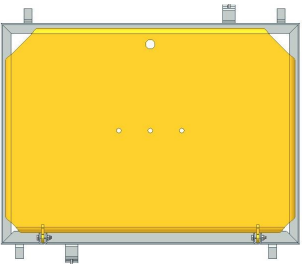













# PERI Nájemní kritéria

## Průmyslové lešení



Průlez s poklopem UAF	Popis	Instrukce	Fakturace	Typ
	<p>33.40.24 Hák velmi deformovaný, utržený</p>			
	<p>33.40.25 Jistící hák prasklý</p>			
	<p>33.40.26 Poškozený poklop   nepoužitelný</p>	 <p>110214 (75x100) 110275 (50x75)</p>		

Žebřík UAF 200 (109879)	Popis	Instrukce	Fakturace	Typ	
	<b>33.40.27 Hák ohnutý</b>				
	<ul style="list-style-type: none"> <li>■ Oprava je možná</li> </ul>			088244	
	<ul style="list-style-type: none"> <li>■ Není možná oprava</li> </ul>		109875 (Jistící hák) 104280 (Nýt )		
<ul style="list-style-type: none"> <li>■ Prasklina v materiálu</li> </ul>		109875 (Jistící hák) 104280 (Nýt )			
	<b>33.40.28 Patka</b>				
	<ul style="list-style-type: none"> <li>■ Chybějící</li> </ul>		110561 (Patka) 125661 (Šroub)		
<ul style="list-style-type: none"> <li>■ Poškozená</li> </ul>		110561 (Patka) 125661 (Šroub)			

### Trn UH | Držák horizontály

Č.      Popis      Číslo výrobek

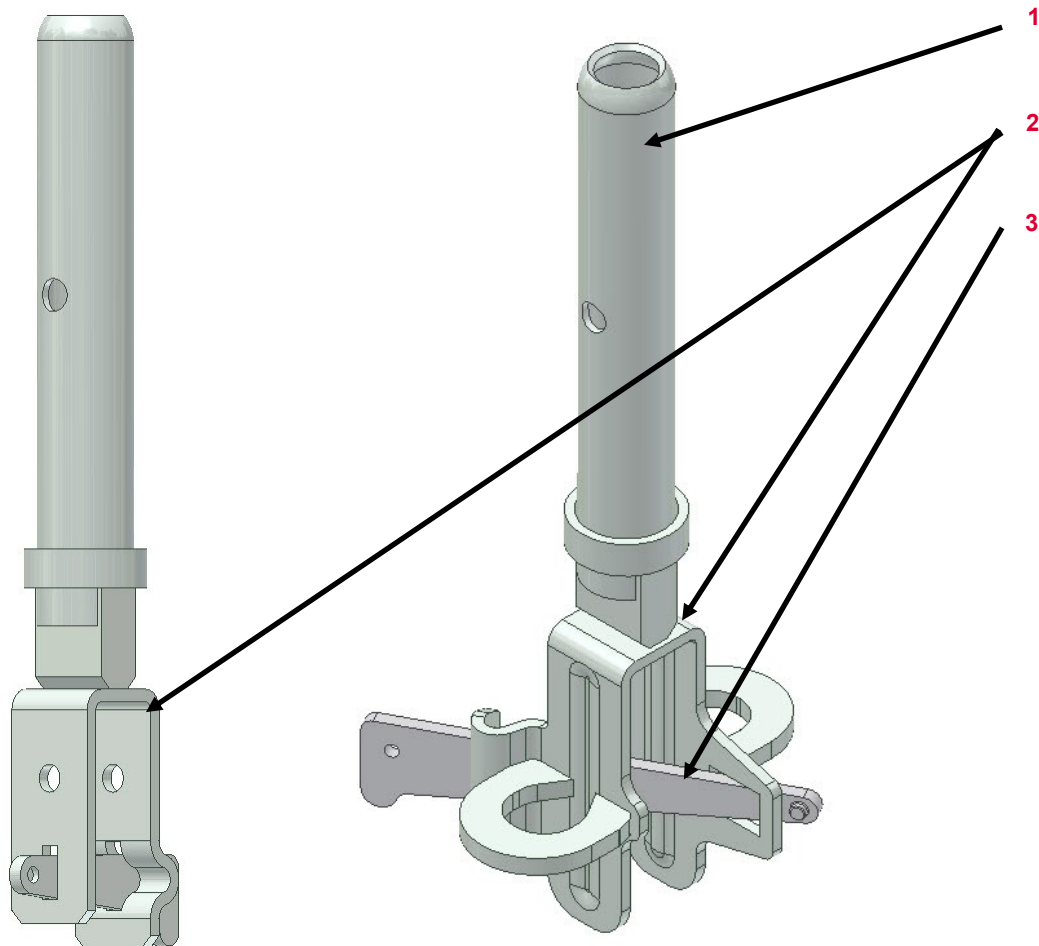

- 1      Trn
- 2      Jistící hák
- 3      Klínek

Platné pro:	Číslo výrobku
Trn UH	109764
Trn UH	130681
Držák horizontály UHA	101731
Oboustranný držák horizontály UHA	110793
Trn s držákem horizontál UHA	110792
Trn s držákem horizontál UHA	130684

# PERI Nájemní kritéria

## Průmyslové lešení



Trn UH   Držák horizontály	Popis	Instrukce	Fakturace	Typ
----------------------------	-------	-----------	-----------	-----



33.40.29 Trn ohnutý | promáčknutý



33.40.30 Hák ohnutý

■ Oprava je možná a není prasklina v materiálu



088244



■ Není možná oprava



# PERI Nájemní kritéria

## Průmyslové lešení



Trn UH   Držák horizontály	Popis	Instrukce	Fakturace	Typ
----------------------------	-------	-----------	-----------	-----



Prasklý svár



Žebříkové připojení UAC-2 (124813)	Popis	Instrukce	Fakturace	Typ
------------------------------------	-------	-----------	-----------	-----



### 33.40.31 Lokální poškození profilu

- Hrana není poškozena



### 33.40.32 Vytržená část u klínu | Klínek chybějící



Žebříkové připojení UAC-2 (124813)	Popis	Instrukce	Fakturace	Typ
------------------------------------	-------	-----------	-----------	-----



33.40.33 Profil promáčkнутý na hraně

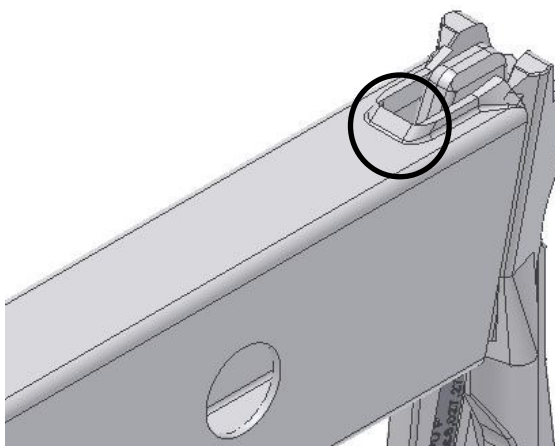

■ 33.40.34 Důlky u klíčku

■ Není poškozená hrana



088244



■ Je poškozená hrana a není možná oprava



■ Prasklina v materiálu



Žebříkové připojení UAC-2 (124813)	Popis	Instrukce	Fakturace	Typ
------------------------------------	-------	-----------	-----------	-----



### 33.40.35 Promáčknutý otvor

- Není změněna geometrie
- Je změněna geometrie
- Prasklina v materiálu



088244

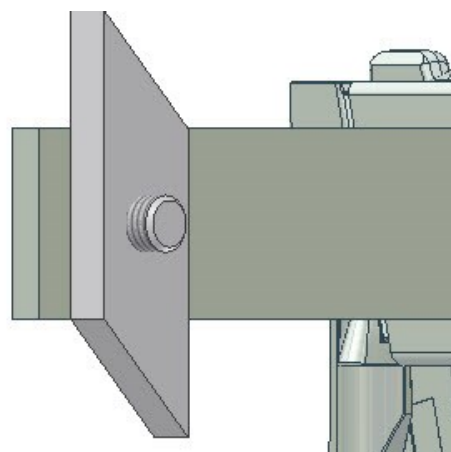

### 33.40.36 Upínání opěry

- Chybějící
- Nepohyblivé















701763 (Upínání opěry)  
710266 (Čep)

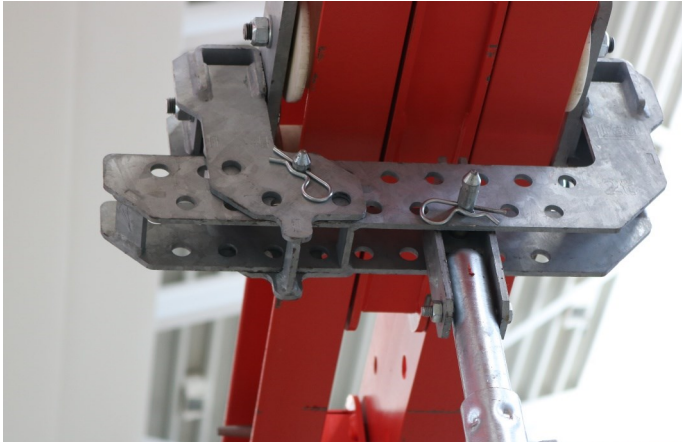

701763 (Upínání opěry)  
710266 (Čep)







Trolej UFS 20 (126497)	Popis	Instrukce	Fakturace	Typ
	<b>33.40.37 Přírubové kolo</b>	 127436 (Přírubové kolo)		
	<ul style="list-style-type: none"> <li>■ Opotřebované</li> </ul>	 127436 (Přírubové kolo)		
	<b>33.40.38 Čep   Závlačka</b>	 018050 (Čep) 018060 (Závlačka )		
	<ul style="list-style-type: none"> <li>■ Chybějící</li> </ul>	 018050 (Čep) 018060 (Závlačka )		
<ul style="list-style-type: none"> <li>■ Poškození hrubou silou</li> </ul>				

# PERI Nájemní kritéria

## Průmyslové lešení



Trolley UFS 20 (126497)	Popis	Instrukce	Fakturace	Typ
	<b>33.40.39 Trn ohnutý</b>			
	■ Oprava je možná		 088244	
	■ Není možná oprava	 127447 (Trn )		

### Meziprvek | Koncový prvek ULS Flex

Č.      Popis      Číslo výrobek

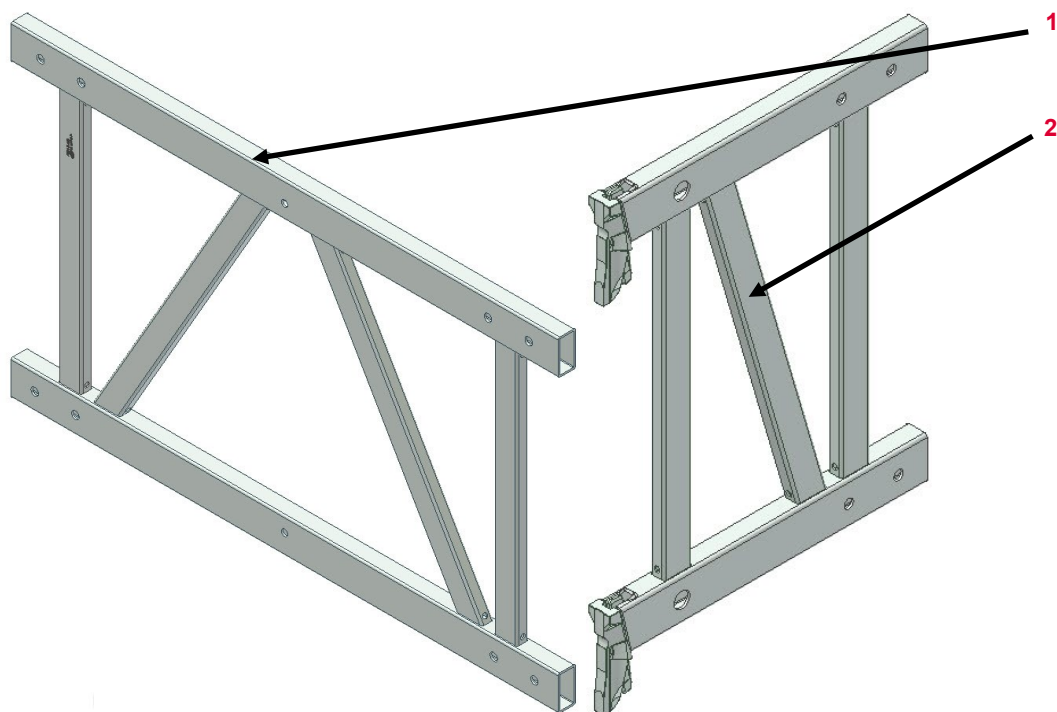

- 1      Rám
- 2      Diagonála

#### Platné pro:

















#### Číslo výrobku















Meziprvek ULS 100 FLEX	124795
Meziprvek ULS 125 FLEX	124790
Meziprvek ULS 150 FLEX	124781
Koncový prvek ULS 50 FLEX	124805

# PERI Nájemní kritéria

## Průmyslové lešení



Meziprvěk   Koncový prvek ULS Flex	Popis	Instrukce	Fakturace	Typ
	<b>33.40.40 Prvek ohnutý</b> <ul style="list-style-type: none"> <li>■ Oprava je možná a Čepy je možné vsunout</li> </ul>		 088244	
	<ul style="list-style-type: none"> <li>■ Není možná oprava</li> <li>■ Prasklina v materiálu</li> </ul>			
	<b>33.40.41 Rám   diagonála ohnutá</b> <ul style="list-style-type: none"> <li>■ Funkční</li> </ul>			
	<ul style="list-style-type: none"> <li>■ Nefukční</li> </ul>			
	<ul style="list-style-type: none"> <li>■ ohnutý</li> </ul>			

Konektor ULS Flex (124806)	Popis	Instrukce	Fakturace	Typ		
	<b>33.40.42 Spojení ohnuté</b>	<ul style="list-style-type: none"> <li>■ Oprava je možná a Čepy je možné vsunout</li> </ul>		 088244		
	<ul style="list-style-type: none"> <li>■ Není možná oprava</li> <li>■ Prasklina v materiálu</li> </ul>					
	<b>33.40.43 Čep / Závlačka</b>	<ul style="list-style-type: none"> <li>■ Chybějící</li> </ul>		018060 (Závlačka 124771 (Čep))		
	<ul style="list-style-type: none"> <li>■ Poškození hrubou silou</li> </ul>		018060 (Závlačka 124771 (Čep))			

# PERI Nájemní kritéria

## Průmyslové lešení



### Bezpečnostní dvířka UPS (125672,126675)

Č. Popis Číslo výrobek

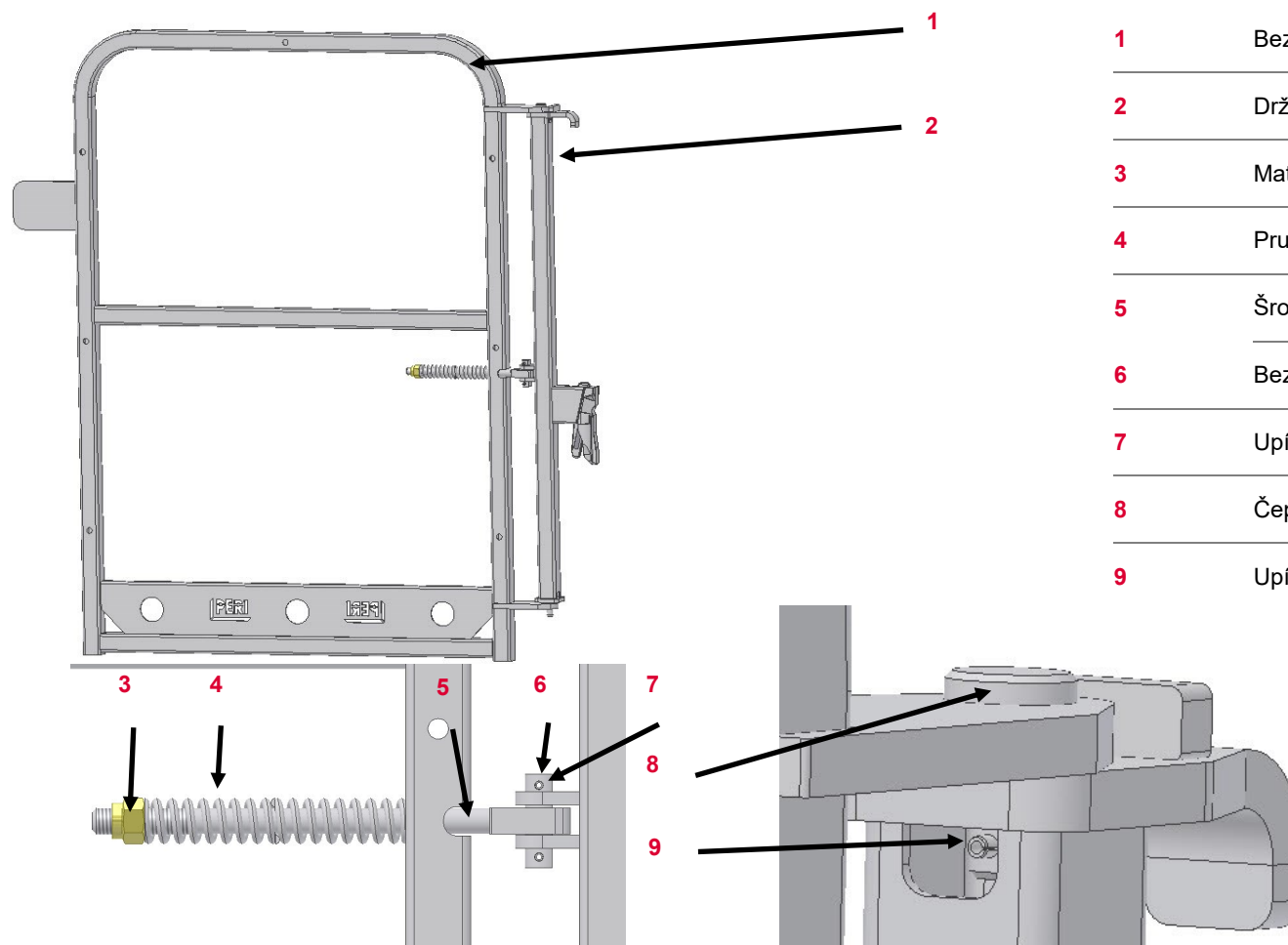





















1	Bezpečnostní dvířka	
2	Držadlo	
3	Matice	
4	Pružina	126560
5	Šroub s okem	125671
6	Bezpečnostní západka	126747
7	Upínací vložka 4x26	710683
8	Čep 10x24	126471
9	Upínací vložka 3x16	710916

# PERI Nájemní kritéria

## Průmyslové lešení



Bezpečnostní dvířka UPS (125672,126675)	Popis	Instrukce	Fakturace	Typ
	<b>Části výrobku</b>	<ul style="list-style-type: none"> <li>■ Chybí </li> </ul>		
	<ul style="list-style-type: none"> <li>■ Poškozené silou </li> </ul>			
	<ul style="list-style-type: none"> <li>■ Opotřebované </li> </ul>			
	<b>Ohnuté části</b>	<ul style="list-style-type: none"> <li>■ Lze narovnat </li> </ul>		
	<ul style="list-style-type: none"> <li>■ Nelze narovnat </li> </ul>			

# PERI Nájemní kritéria

## Průmyslové lešení



H- Diagonála žebříku UAD	Popis	Instrukce	Fakturace	Typ
--------------------------	-------	-----------	-----------	-----



Viditelné ohnutí



Ohnutá spojka

- Lze narovnat
- Nelze narovnat
- Klínek chybí





# PERI Nájemní kritéria

## Průmyslové lešení



Držák žebříku UAM-S (134520)	Popis	Instrukce	Fakturace	Typ
------------------------------	-------	-----------	-----------	-----

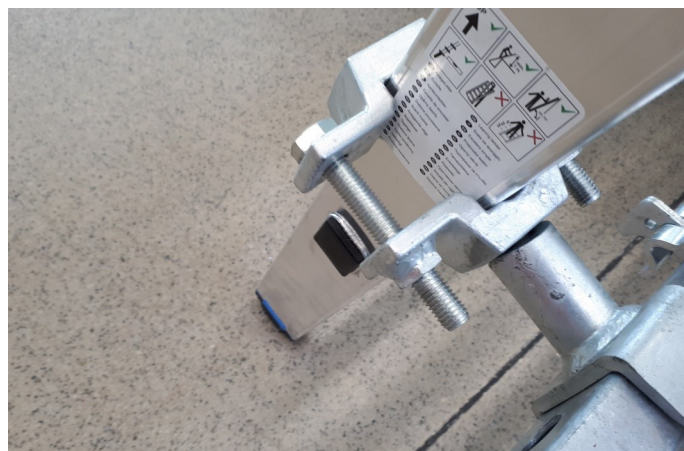

Šroub

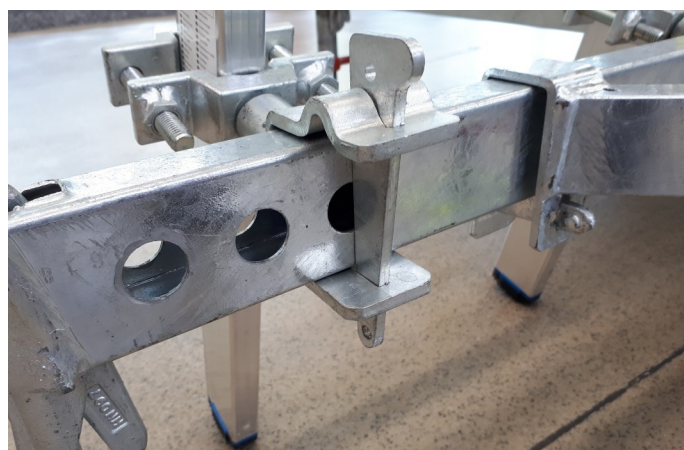

Ohnutá spojka

- Lze narovnat
- Nelze narovnat
- Klínek chybí



Držák žebříku UAM-W (134527)	Popis	Instrukce	Fakturace	Typ
------------------------------	-------	-----------	-----------	-----

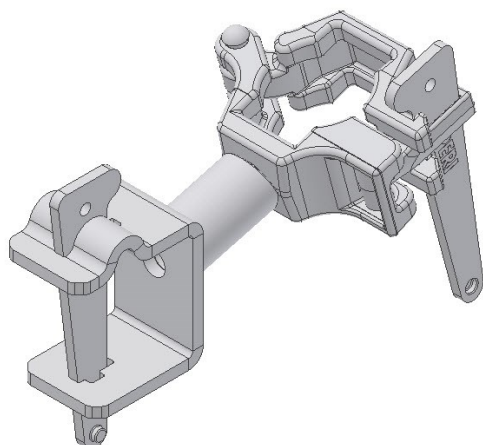

Ohnutý prvek

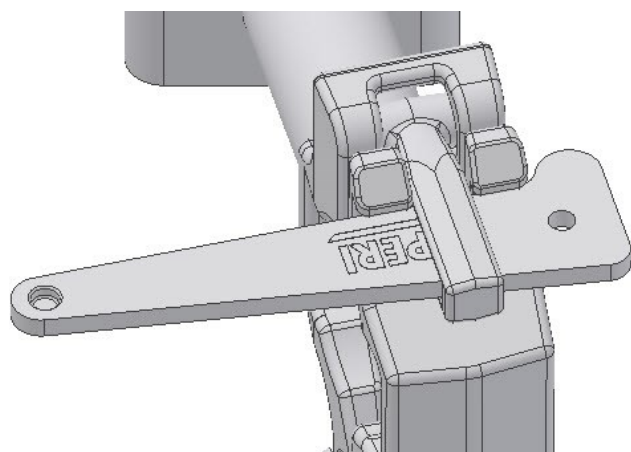

Klínek chybí



# PERI Nájemní kritéria

## Průmyslové lešení



Základní sloupek VARIOKIT UVA (136779)	Popis	Instrukce	Fakturace	Typ
--	-------	-----------	-----------	-----



### Ohnutá rozeta

■ ≤ 20 mm



■ > 20 mm



### Ohnuté spojení nebo trn

■ Nelze sestavovat



■ Praskliny v materiálu



# PERI Nájemní kritéria

## Průmyslové lešení

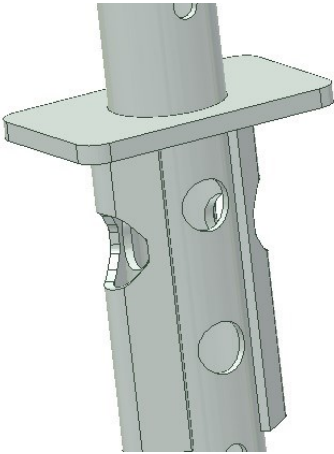

Základní sloupek VARIOKIT UVA (136779)	Popis	Instrukce	Fakturace	Typ
	Ohnutý plát			
	<ul style="list-style-type: none"> <li>■ Lze narovnat</li> </ul>			
	<ul style="list-style-type: none"> <li>■ Nelze narovnat</li> </ul>			

# PERI Nájemní kritéria

## Vysvětlivky znaků



Znak	Význam	Znak	Význam	Znak	Význam
	Není v pořádku – materiál je poškozený		Fakturuje se zákazníkovi		Optické poškození
	OK – materiál zůstává v nájemním skladu		Nefakturuje se zákazníkovi		Funkční poškození
	Poškozený materiál – <b>není dovoleno</b> vydávat materiál z bezpečnostních důvodů		Zkrácení prvku		Funkční poškození — <b>není dovoleno</b> vydávat materiál z bezpečnostních důvodů
	Oprava dle instrukcí		Označení prvku barvou		Statické poškození — <b>není dovoleno</b> vydávat materiál z bezpečnostních důvodů
	Oprava za studena — poté kontrola svárů a sousedních dílů		Výměna poškozeného dílu		
	Oprava po výpočtu hospodárnosti		Doplnění chybějícího dílu		
	Očištění materiálu				