

# PERI Nájemní kritéria

## Konzola MAT FLEX

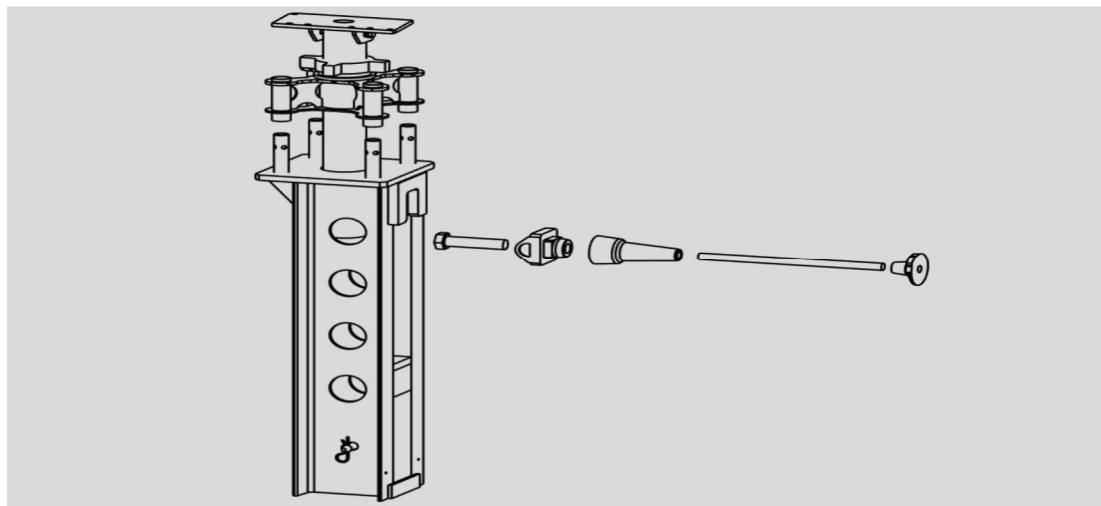

### Kontakt

**PERI, spol. s r.o.**  
**bednění lešení služby**

Průmyslová 392  
 252 42 Jesenice u Prahy  
 tel.: 222 359 311

| Obsah            | Strana | Poslední změny | Datum   Iniciály | Strana |
|------------------|--------|----------------|------------------|--------|
| Konzola MAT FLEX | 2      | Nová verze     | 04/2019   vk     |        |
| Nosník HEB 300   | 9      |                |                  |        |
| Vložka k HEB 300 | 10     |                |                  |        |
|                  |        |                |                  |        |
|                  |        |                |                  |        |
|                  |        |                |                  |        |
|                  |        |                |                  |        |
|                  |        |                |                  |        |
|                  |        |                |                  |        |

# PERI Nájemní kritéria

## Bednění kruhových sloupů SRS



| Konzola MAT FLEX ( 200153) | Č. | Popis | Číslo výrobku |
|----------------------------|----|-------|---------------|
|----------------------------|----|-------|---------------|

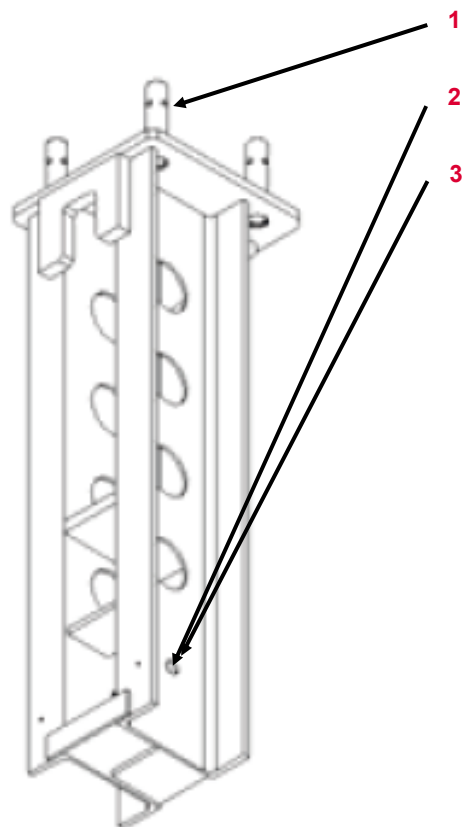

|   |                      |        |
|---|----------------------|--------|
| 1 | Konzola MAT FLEX     | 200153 |
| 2 | Závlačka 5/1         | 022230 |
| 3 | Pravoúhlý čep 25x210 | 104224 |
|   |                      |        |
|   |                      |        |
|   |                      |        |
|   |                      |        |
|   |                      |        |

# PERI Nájemní kritéria

## Bednění kruhových sloupů SRS



| Výrobek          | Číslo výrobku |
|------------------|---------------|
| Konzola MAT FLEX | 200153        |
| HEB300           | 200151        |
| Vložka k HEB300  | 200152        |
|                  |               |
|                  |               |
|                  |               |
|                  |               |
|                  |               |
|                  |               |
|                  |               |
|                  |               |
|                  |               |
|                  |               |
|                  |               |
|                  |               |
|                  |               |
|                  |               |
|                  |               |
|                  |               |
|                  |               |

| Výrobek | Číslo výrobku |
|---------|---------------|
|         |               |
|         |               |
|         |               |
|         |               |
|         |               |
|         |               |
|         |               |
|         |               |
|         |               |
|         |               |
|         |               |
|         |               |
|         |               |
|         |               |
|         |               |
|         |               |
|         |               |
|         |               |
|         |               |
|         |               |

# PERI Nájemní kritéria

## Konzola MAT-FLEX













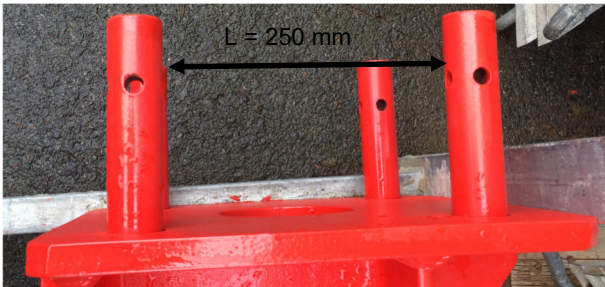

| Konzola MAT FLEX | Popis   | Instrukce  | Fakturace | Typ |  |
|------------------|---|--|-----------|-----|--|
|                  | <b>65.01 Ohnutý profil UPE 240</b>                            | <ul style="list-style-type: none"> <li>■ ≤ 3 mm</li> </ul> |           |     |  |
|                  | <ul style="list-style-type: none"> <li>■ &gt; 3 mm</li> </ul> |  |           |     |  |
|                  | <b>65.02 Ohnutý profil UPE 240 (méně tuhá strana)</b>         | <ul style="list-style-type: none"> <li>■ ≤ 5 mm</li> </ul> |           |     |  |
|                  | <ul style="list-style-type: none"> <li>■ &gt; 5 mm</li> </ul> |  |           |     |  |

# PERI Nájemní kritéria

## Konzola MAT-FLEX

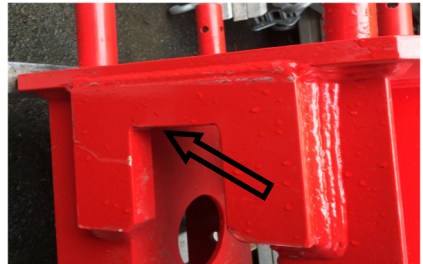



















| Konzola MAT Flex  | Popis   | Instrukce  | Fakturace  | Typ  |
|---|---|--|--|--|
|    | <p><b>65.03 Poškozený svár</b></p> <ul style="list-style-type: none"> <li>■ Trhliny ve svárech</li> </ul>                                 |   |   |   |
|   | <p><b>65.04 Ohnuté spojovací trubky</b></p> <ul style="list-style-type: none"> <li>■ L= 250 +-1mm</li> <li>■ L= 250 +- &gt;1mm</li> </ul> | <br> | <br> | <br> |
|  | <p><b>65.05 Povrch dosedacích ploch</b></p> <ul style="list-style-type: none"> <li>■ Zářezy, záseky</li> </ul>                            |  Volat technické oddělení<br>(Martina Jančáka)  |  |   |

# PERI Nájemní kritéria

## Konzola MAT-FLEX





















| Konzola MAT Flex  | Popis  | Instrukce  | Fakturace  | Typ  |
|---|--|--|--|--|
|  <p>Ilustrační obrázek</p>   | <b>65.06 Zkrácená</b>  |    |   |   |
|  <p>Ilustrační obrázek</p>  | <b>65.07 Zářez</b> <ul style="list-style-type: none"> <li>■ <math>t \leq 10 \text{ mm}</math></li> <li>■ <math>t &gt; 10 \text{ mm}</math></li> </ul>                        | <div style="display: flex; align-items: center;">  <div style="margin-left: 10px;">Sváření</div> </div>   | <br> | <br> |
|  <p>Ilustrační obrázek</p> | <b>65.08 Vyvrtné otvory</b> <ul style="list-style-type: none"> <li>■ <math>&gt; \text{Ø } 8 \text{ mm}</math></li> <li>■ <math>&lt; \text{Ø } 8 \text{ mm}</math></li> </ul> |  <br> <div style="margin-left: 10px;">(Vždy konzultace s technikou)</div>                               |   |   |

# PERI Nájemní kritéria

## Konzola MAT-FLEX





| Konzola MAT Flex  | Popis  | Instrukce   | Fakturace   | Typ  |
|---|--|---|---|--|
|  <p>Ilustrační obrázek</p>   | <b>65.09 Zbroušená koncovka profilu</b> <ul style="list-style-type: none"> <li>■ Je-li původní délka</li> <li>■ Není-li původní délka</li> </ul> | <ul style="list-style-type: none"> <li></li> <li> </li> </ul>                                    | <ul style="list-style-type: none"> <li></li> <li></li> </ul>            | <ul style="list-style-type: none"> <li></li> <li></li> </ul>     |
|   |  <p>Ilustrační obrázek</p>                                     | <b>65.10 Ohnutý profil</b>  |  ( Volat technické oddělení )  |  088244   |
|  <p>Ilustrační obrázek</p> | <b>65.11 Promáčklý profil</b> <ul style="list-style-type: none"> <li>■ Je možné srovnat</li> <li>■ Není možné srovnat</li> </ul>                 | <ul style="list-style-type: none"> <li> ( Volat technické oddělení )</li> <li> </li> </ul> | <ul style="list-style-type: none"> <li> 088244</li> <li></li> </ul> | <ul style="list-style-type: none"> <li></li> <li></li> </ul> |

# PERI Nájemní kritéria

## Konzola MAT-FLEX



| Nosník HEB300 (200151)  | Popis   | Instrukce  | Fakturace  | Typ  |
|---|---|--|--|--|
|    | <p><b>65.12 Ohnutý profil HEB300</b></p> <ul style="list-style-type: none"> <li>■ ≤ 3 mm</li> <li>■ &gt; 3 mm</li> </ul>                    | <ul style="list-style-type: none"> <li>✓</li> <li>✗</li> </ul> | <ul style="list-style-type: none"> <li>✗</li> <li>✓</li> </ul> | <ul style="list-style-type: none"> <li>⚙️</li> <li>⚙️</li> </ul> |
|  | <p><b>65.13 Ohnutý profil HEB300 (méně tuhá strana)</b></p> <ul style="list-style-type: none"> <li>■ ≤ 3 mm</li> <li>■ &gt; 3 mm</li> </ul> | <ul style="list-style-type: none"> <li>✓</li> <li>✗</li> </ul> | <ul style="list-style-type: none"> <li>✗</li> <li>✓</li> </ul> | <ul style="list-style-type: none"> <li>⚙️</li> <li>kg</li> </ul> |



| Nosník HEB300 (200151) | Popis | Instrukce | Fakturace | Typ |
|------------------------|-------|-----------|-----------|-----|
|------------------------|-------|-----------|-----------|-----|

### 65.14 Poškozený svár



- Trhliny ve svárech



### 65.15 Deformace výztužných žeber



- Vizuální kontrola—boule , vyhnutí





















Volat technické oddělení

# PERI Nájemní kritéria

## Konzola MAT-FLEX





| Nosník HEB300 (200151)  | Popis  | Instrukce   | Fakturace  | Typ  |
|---|--|---|--|--|
|  <p>Ilustrační obrázek</p>   | <b>65.06 Zkrácená</b>  |     |   |   |
|  <p>Ilustrační obrázek</p>  | <b>65.07 Zářez</b> <ul style="list-style-type: none"> <li>■ <math>t \leq 10 \text{ mm}</math></li> <li>■ <math>t &gt; 10 \text{ mm}</math></li> </ul>                            | <div style="display: flex; align-items: center;">  <div style="margin-left: 5px;">Sváření</div> </div>   | <br> | <br> |
|  <p>Ilustrační obrázek</p> | <b>65.08 Vyvrtné otvory</b> <ul style="list-style-type: none"> <li>■ <math>&gt; \varnothing 8 \text{ mm}</math></li> <li>■ <math>&lt; \varnothing 8 \text{ mm}</math></li> </ul> |  <br> <div style="margin-left: 10px;">( Volat technické oddělení )</div>                               |   |   |

# PERI Nájemní kritéria

## Konzola MAT-FLEX











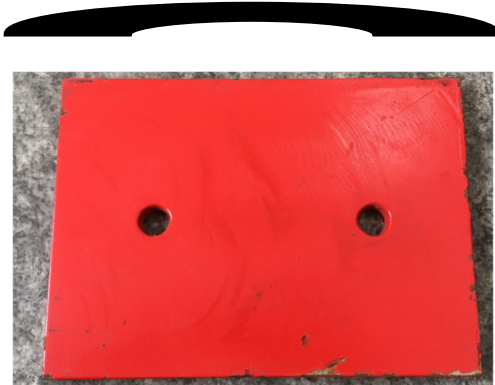



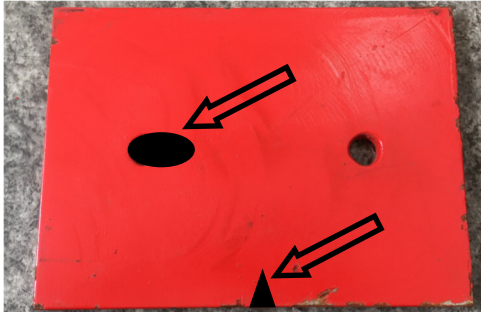

| Nosník HEB300 (200151)  | Popis   | Instrukce  | Fakturace   | Typ  |
|---|---|--|---|--|
|  <p>Ilustrační obrázek</p>   | <p><b>65.09 Zbroušená koncovka profilu</b></p> <ul style="list-style-type: none"> <li>■ Je-li původní délka</li> <li>■ Není-li původní délka</li> </ul> | <ul style="list-style-type: none"> <li>✓</li> <li>🗑️ 🚫</li> </ul>                              | <ul style="list-style-type: none"> <li>🚫</li> <li>📄</li> </ul>        | <ul style="list-style-type: none"> <li>👁️</li> <li>⚙️</li> </ul> |
|  <p>Ilustrační obrázek</p>  | <p><b>65.10 Ohnutý profil</b></p>   | <ul style="list-style-type: none"> <li>🔨 ( Volat technické oddělení )</li> </ul>               | <ul style="list-style-type: none"> <li>📄 088244</li> </ul>            | <ul style="list-style-type: none"> <li>👁️</li> </ul>             |
|  <p>Ilustrační obrázek</p> | <p><b>65.11 Promáčklý profil</b></p> <ul style="list-style-type: none"> <li>■ Je možné srovnat</li> <li>■ Není možné srovnat</li> </ul>                 | <ul style="list-style-type: none"> <li>🔨 ( Volat technické oddělení )</li> <li>🗑️ 🚫</li> </ul> | <ul style="list-style-type: none"> <li>📄 088244</li> <li>📄</li> </ul> | <ul style="list-style-type: none"> <li>⚙️</li> <li>⚙️</li> </ul> |

# PERI Nájemní kritéria

## Konzola MAT-FLEX

















| Vložka k HEB 300 (200152)   | Popis   | Instrukce   | Fakturace   | Typ   |   |
|---|---|---|---|---|---|
|    | <b>65.16 Ohnutý profil Vložka HEB300</b>                      | <ul style="list-style-type: none"> <li>■ ≤ 1 mm</li> </ul>  |    |    |  |
|   | <ul style="list-style-type: none"> <li>■ &gt; 1 mm</li> </ul> |       |    |   |   |
|  | <b>65.17 Otvory—záseky do hran, zvětšený otvor</b>            | <ul style="list-style-type: none"> <li>■ ≤ 1 mm</li> </ul>  |  |    |   |
|   | <ul style="list-style-type: none"> <li>■ &gt; 1 mm</li> </ul> |   |  |    |   |

# PERI Nájemní kritéria

## Konzola MAT-FLEX





| Vložka k HEB 300 (200152)   | Popis   | Instrukce  | Fakturace  | Typ  |
|---|---|--|--|--|
|  <p>Ilustrační obrázek</p>   | <p>65.06 Zkrácená</p>   |   |   |   |
|  <p>Ilustrační obrázek</p>  | <p>65.07 Zářez</p> <ul style="list-style-type: none"> <li>■ <math>t \leq 16 \text{ mm}</math></li> <li>■ <math>t &gt; 16 \text{ mm}</math></li> </ul> | <ul style="list-style-type: none"> <li>  Sváření         </li> <li>  </li> </ul> | <ul style="list-style-type: none"> <li></li> <li></li> </ul> | <ul style="list-style-type: none"> <li></li> <li></li> </ul> |
|  <p>Ilustrační obrázek</p> | <p>65.08 Vyvrtné otvory</p> <ul style="list-style-type: none"> <li>■ <math>&gt; \varnothing 16 \text{ mm}</math></li> </ul>                           |   |   |   |

# PERI Nájemní kritéria

## Konzola MAT-FLEX



| Vložka k HEB 300 (200152)   | Popis  | Instrukce   | Fakturace   | Typ  |
|---|--|---|---|--|
|  <p>Ilustrační obrázek</p>   | <b>65.09 Zbroušená koncovka profilu</b> <ul style="list-style-type: none"> <li>■ Je-li původní délka</li> <li>■ Není-li původní délka</li> </ul> | <ul style="list-style-type: none"> <li></li> <li> </li> </ul> | <ul style="list-style-type: none"> <li></li> <li></li> </ul>        | <ul style="list-style-type: none"> <li></li> <li></li> </ul> |
|  <p>Ilustrační obrázek</p>  | <b>65.10 Ohnutý profil</b>   | <ul style="list-style-type: none"> <li></li> </ul>            | <ul style="list-style-type: none"> <li> 088244</li> </ul>           | <ul style="list-style-type: none"> <li></li> </ul>           |
|  <p>Ilustrační obrázek</p> | <b>65.11 Promáčklý profil</b> <ul style="list-style-type: none"> <li>■ Je možné srovnat</li> <li>■ Není možné srovnat</li> </ul>                 | <ul style="list-style-type: none"> <li></li> <li> </li> </ul> | <ul style="list-style-type: none"> <li> 088244</li> <li></li> </ul> | <ul style="list-style-type: none"> <li></li> <li></li> </ul> |

# PERI Nájemní kritéria

## Bednění kruhových sloupů SRS



| Znak  | Význam   | Znak   | Význam                     | Znak  | Význam   |
|---|--|--|----------------------------|---|--|
|    | Není v pořádku – materiál je poškozený   |   | Fakturuje se zákazníkovi   |  | Optické poškození  |
|    | OK – materiál zůstává v nájemním skladu  |   | Nefakturuje se zákazníkovi |  | Funkční poškození  |
|    | Poškozený materiál – <b>není dovoleno</b> vydávat materiál z bezpečnostních důvodů |   | Zkrácení prvku             |  | Funkční poškození — <b>není dovoleno</b> vydávat materiál z bezpečnostních důvodů  |
|    | Oprava dle instrukcí   |   | Označení prvku barvou      |  | Statické poškození — <b>není dovoleno</b> vydávat materiál z bezpečnostních důvodů |
|    | Oprava za studena — poté kontrola svárů a sousedních dílů                          |   | Výměna poškozeného dílu    |   |  |
|   | Oprava po výpočtu hospodárnosti  |  | Doplnění chybějícího dílu  |   |  |
|  | Očištění materiálu   |  |                            |   |  |

# PERI Nájemní kritéria

## Bednění kruhových sloupů SRS



| GT 24 Schalungsträger | Č. | Popis               | Číslo výrobku |
|-----------------------|----|---------------------|---------------|
| 1                     | 1  | Gurtholz            | keine         |
|                       | 2  | Strebe              | keine         |
| 2                     | 3  | Stahlkappe verzinkt | 726041        |
|                       | 4  | Stahl-Rohrniet      | 726040        |
| 3                     |    |                     |               |
|                       |    |                     |               |
| 4                     |    |                     |               |
|                       |    |                     |               |
|                       |    |                     |               |



# PERI Nájemní kritéria

## Bednění kruhových sloupů SRS



| Schaden | Popis | Instrukce | Fakturace | Typ |
|---------|-------|-----------|-----------|-----|
|---------|-------|-----------|-----------|-----|

---

# PERI Nájemní kritéria

## Bednění kruhových sloupů SRS



| Č. | Popis               | Číslo výrobku |
|----|---------------------|---------------|
| 1  | Gurtholz            | keine         |
| 2  | Strebe              | keine         |
| 3  | Stahlkappe verzinkt | 726041        |
| 4  | Stahl-Rohrniet      | 726040        |

| Schaden | Popis | Instrukce | Fakturace | Typ |
|---------|-------|-----------|-----------|-----|
|---------|-------|-----------|-----------|-----|

# PERI Nájemní kritéria

## Konzola MAT FLEX



### Kontakt

**PERI, spol. s r.o.**  
**bednění řešení služby**  
Průmyslová 392  
252 42 Jesenice u Prahy  
tel.: 222 359 311

| Inhalt | Seite |
|--------|-------|
|        |       |
|        |       |
|        |       |
|        |       |

| Inhalt | Seite |
|--------|-------|
|        |       |
|        |       |
|        |       |
|        |       |

# PERI Nájemní kritéria

## Konzola MAT FLEX



### Kontakt

**PERI, spol. s r.o.**  
**bednění lešení služby**  
Průmyslová 392  
252 42 Jesenice u Prahy  
tel.: 222 359 311

| Vorgenommene Änderungen | Datum   Kürzel, Wer | Seite |
|-------------------------|---------------------|-------|
| Neuerstellung Layout    | 07/2015   rf        |       |
|                         |                     |       |
|                         |                     |       |
|                         |                     |       |
|                         |                     |       |
|                         |                     |       |
|                         |                     |       |
|                         |                     |       |
|                         |                     |       |
|                         |                     |       |

| Vorgenommene Änderungen | Datum   Kürzel, Wer | Seite |
|-------------------------|---------------------|-------|
| Neuerstellung Layout    | 07/2015   rf        |       |
|                         |                     |       |
|                         |                     |       |
|                         |                     |       |
|                         |                     |       |
|                         |                     |       |
|                         |                     |       |
|                         |                     |       |
|                         |                     |       |
|                         |                     |       |

# PERI Nájemní kritéria

## Konzola MAT FLEX



### Kontakt

**PERI, spol. s r.o.**  
**bednění řešení služby**  
Průmyslová 392  
252 42 Jesenice u Prahy  
tel.: 222 359 311

| Inhalt | Seite |
|--------|-------|
|        |       |
|        |       |
|        |       |
|        |       |
|        |       |
|        |       |
|        |       |

| Inhalt | Seite |
|--------|-------|
|        |       |
|        |       |
|        |       |
|        |       |
|        |       |
|        |       |
|        |       |







**Ab hier folgen die Seiten für die Schäden auf Basis der Gestaltungsvorlage für eine Zeile.**

**Die Abstände der Zeilen sind dadurch verschiebbar.**

# PERI Nájemní kritéria

## Konzola MAT-FLEX



| Schaden   Xyyyyy | Popis | Instrukce  | Fakturace  | Typ  |
|------------------|-------|--|--|--|
|                  |       |   |   |   |
|                  |       |  |  |  |

# PERI Nájemní kritéria

## Konzola MAT-FLEX



| Schaden   Xyyyyy | Popis | Instrukce | Fakturace | Typ |
|------------------|-------|-----------|-----------|-----|
|                  |       |           |           |     |
|                  |       |           |           |     |
|                  |       |           |           |     |



# PERI Nájemní kritéria

## Konzola MAT-FLEX



| Schaden   Xyyyyy | Popis | Instrukce | Fakturace | Typ |
|------------------|-------|-----------|-----------|-----|
|                  |       |           |           |     |
|                  |       |           |           |     |
|                  |       |           |           |     |
|                  |       |           |           |     |

**Ab hier folgen die Seiten für die Schäden auf Basis unterschiedlicher Gestaltungsvorlagen:**

**1 Zeile, 2 Zeilen, 3 Zeilen und 4 Zeilen**

**Die Abstände der Zeilen sind jeweils nicht verschiebbar.**

# PERI Nájemní kritéria

## Konzola MAT-FLEX









| Schaden   Xyyyyy | Popis | Instrukce | Fakturace | Typ |
|------------------|-------|-----------|-----------|-----|
|                  |       |           |           |     |

# PERI Nájemní kritéria

## Bednění kruhových sloupů SRS



| Schaden | Popis | Instrukce  | Fakturace  | Typ  |
|---------|-------|--|--|--|
|         |       |   |   |   |
|         |       |  |  |  |

# PERI Nájemní kritéria

## Bednění kruhových sloupů SRS



| Schaden | Popis | Instrukce | Fakturace | Typ |
|---------|-------|-----------|-----------|-----|
|         |       |           |           |     |
|         |       |           |           |     |
|         |       |           |           |     |

# PERI Nájemní kritéria

## Bednění kruhových sloupů SRS



| Schaden | Popis | Instrukce | Fakturace | Typ |
|---------|-------|-----------|-----------|-----|
|         |       |           |           |     |
|         |       |           |           |     |
|         |       |           |           |     |
|         |       |           |           |     |

