

PERI Nájemní kritéria

PERI UP Fasádní lešení Easy



Kontakt

PERI, spol. s r.o.
bednění lešení služby

Průmyslová 392
252 42 Jesenice u Prahy
tel.: 222 359 311
info@peri.cz
www.peri.cz

Obsah	Strana	Poslední změny	Datum Iniciály	Strana
Ocelová podlaha EDS	2	Nová verze	03/2017 I fw	
Dřevěná EDW	6			
Rámy	9			
Podlaha s průlezem Podlaha se žebříkem	12			
Diagonála	17			
Zábradlí	19			
Příslušenství	23			
Vysvětlivky	27			

PERI Nájemní kritéria

PERI UP Fasádní lešení Easy



Ocelová podlaha EDS

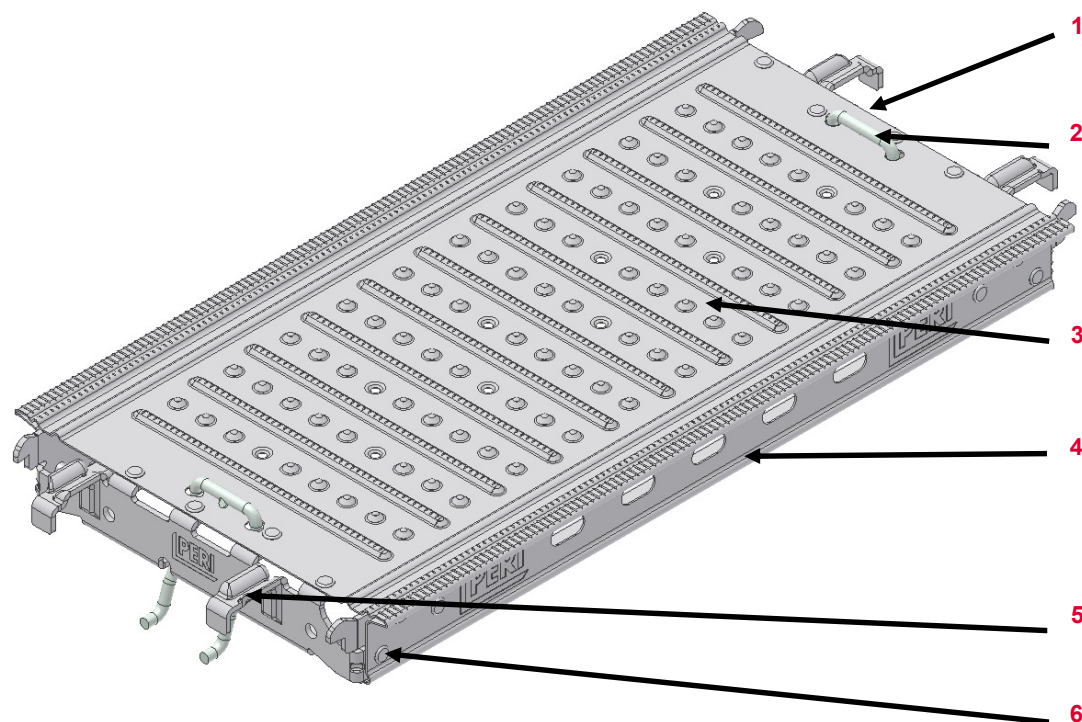











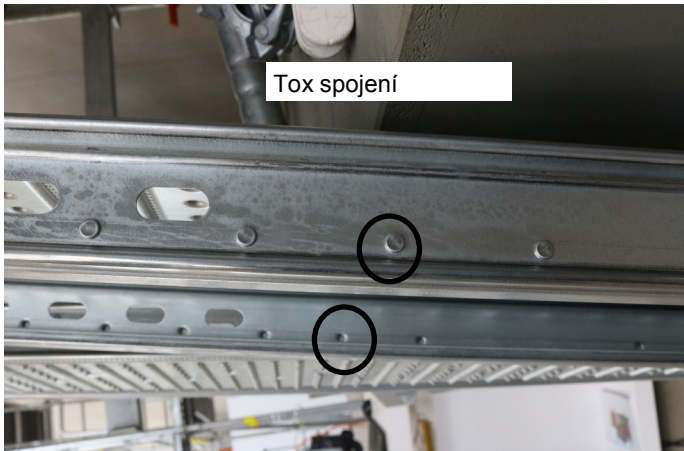







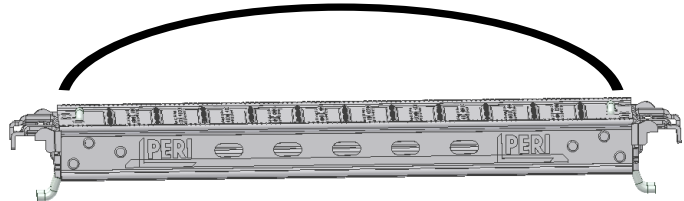

Č.	Popis	Číslo výrobku
1	Závěs EDS	129808
2	Bezpečnostní pojistka	108716
3	Profil podlahy	
4	Boční profil	
5	Montážní háček	
6	Nýt 6,0x 10	723058

Platné pro:	Číslo výrobku
Ocelová podlaha EDS 33x67	130450
Ocelová podlaha EDS 33x100	130448
Ocelová podlaha EDS 33x150	130445
Ocelová podlaha EDS 33x200	130441
Ocelová podlaha EDS 33x250	130438
Ocelová podlaha EDS 33x300	129272

PERI Nájemní kritéria

PERI UP Fasádní lešení Easy

















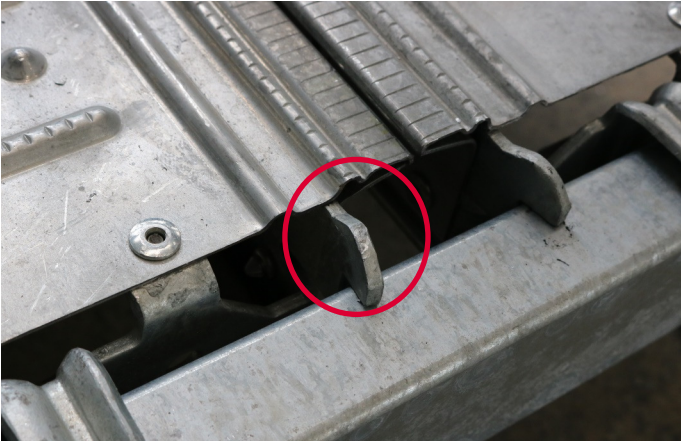

Ocelová podlaha EDS	Popis	Instrukce	Fakturace	Typ												
	33.25.01 Ohnutá hrana profilu															
	<ul style="list-style-type: none"> Osazení podlahy je možné a TOX - nýty nejsou poškozené 	 														
	<ul style="list-style-type: none"> Osazení není možné 	 														
	<ul style="list-style-type: none"> Poškozené TOX - nýty 	 														
	33.25.02 Ohnutá podlaha															
	<ul style="list-style-type: none"> < pov. ohnutí (L/250) > pov. ohnutí (L/250) 	  	 	 												
	<table border="1"> <thead> <tr> <th>Výrobek</th> <th>Pov. ohnutí</th> </tr> </thead> <tbody> <tr> <td>EDS 67 100</td> <td>5 mm</td> </tr> <tr> <td>EDS 150</td> <td>6 mm</td> </tr> <tr> <td>EDS 200</td> <td>8 mm</td> </tr> <tr> <td>EDS 250</td> <td>10 mm</td> </tr> <tr> <td>EDS 300</td> <td>12 mm</td> </tr> </tbody> </table>	Výrobek	Pov. ohnutí	EDS 67 100	5 mm	EDS 150	6 mm	EDS 200	8 mm	EDS 250	10 mm	EDS 300	12 mm			
Výrobek	Pov. ohnutí															
EDS 67 100	5 mm															
EDS 150	6 mm															
EDS 200	8 mm															
EDS 250	10 mm															
EDS 300	12 mm															

PERI Nájemní kritéria

PERI UP Fasádní lešení Easy











Ocelová podlaha EDS	Popis	Instrukce	Fakturace	Typ
	33.25.03 Ohnutý háček <ul style="list-style-type: none"> ■ ≤ 5 mm 			
	<ul style="list-style-type: none"> ■ Prasklý háček 			
	<ul style="list-style-type: none"> ■ > 5 mm 			
	33.25.04 Ohnutý vymežovač <ul style="list-style-type: none"> ■ Bez prasklin 			
	<ul style="list-style-type: none"> ■ S prasklinami 			

PERI Nájemní kritéria

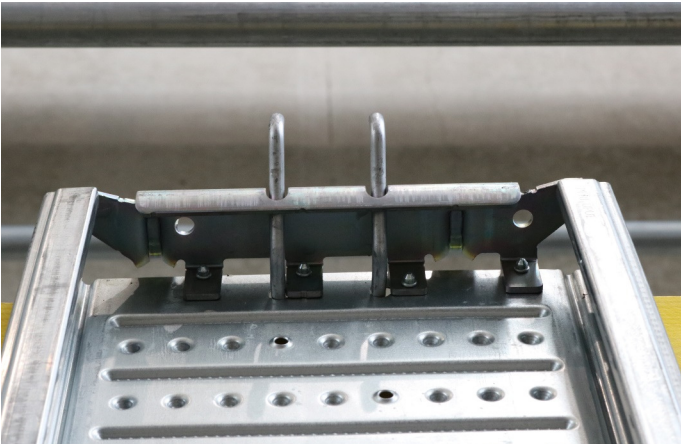
PERI UP Fasádní lešení Easy



Ocelová podlaha EDS	Popis	Instrukce	Fakturace	Typ
	33.25.05 Ohnutý závěs			
	33.25.06 Ohnutá bezpečnostní pojistka nepoužitelná			

PERI Nájemní kritéria

PERI UP Fasádní lešení Easy



Dřevěná podlaha EDW	Č.	Popis	Číslo výrobku
---------------------	----	-------	---------------

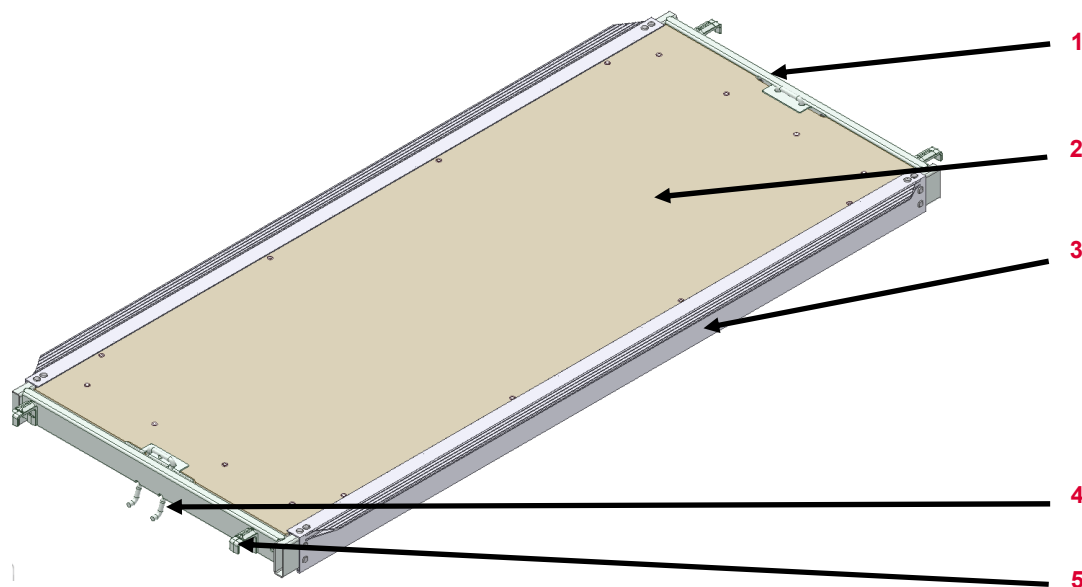



















1	Závěs EDW	130308
2	Podlaha	
3	Boční profil	
4	Bezpečnostní pojistka	
5	Montážní háček	

Platné pro:	Číslo výrobku
Dřevěná podlaha EDW 150	130321
Dřevěná podlaha EDW 200	130317
Dřevěná podlaha EDW 250	130313
Dřevěná podlaha EDW 300	130309

PERI Nájemní kritéria

PERI UP Fasádní lešení Easy























Dřevěná podlaha EDW	Popis	Instrukce	Fakturace	Typ
	33.25.07 Ohnutá hrana profilu	<ul style="list-style-type: none"> ■ Osazení podlahy je možné   		
	<ul style="list-style-type: none"> ■ Osazení podlahy není možné 	 		
	<ul style="list-style-type: none"> ■ Prasklina v materiálu 	 		
	33.25.08 Podlaha	<ul style="list-style-type: none"> ■ Opatřovaná  		
	<ul style="list-style-type: none"> ■ Poškození hrubou silou 			

PERI Nájemní kritéria

PERI UP Fasádní lešení Easy



Dřevěná podlaha EDW	Popis	Instrukce	Fakturace	Typ
	33.25.09 Ohnutý háček <ul style="list-style-type: none"> ■ ≤ 5 mm a bez prasklin 			
	<ul style="list-style-type: none"> ■ > 5 mm ■ Prasklina na háčku 	 130308		
	33.25.10 Bezpečnostní pojistka <ul style="list-style-type: none"> ■ Ohnutá 	 130308		
	<ul style="list-style-type: none"> ■ Chybějící 	 130308		
	33.25.11 Prasklý svár na výztuze <ul style="list-style-type: none"> ■ S deformací na výztuze 			
	<ul style="list-style-type: none"> ■ Bez deformace na výztuze 			

PERI Nájemní kritéria

PERI UP Fasádní lešení Easy



L rám EVH T rám EVF Základní rám EVB Nástavec EVR	Č.	Popis	Číslo výrobku
---	----	-------	---------------

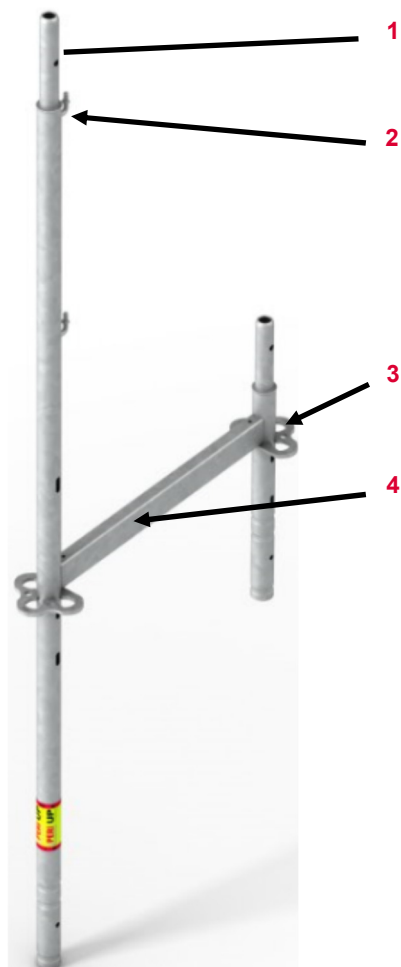















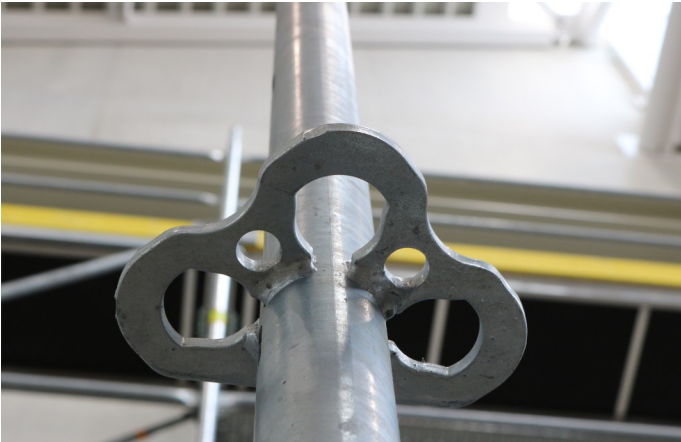

1	Spigot
2	Háček
3	3/4 Rosett
4	Horizontála

Platné pro:	Číslo výrobku
L rám EVH 67	129314
L rám EVH 100	130804
T rám EVF 67	130466
T rám EVF 100	130860
Základní rám EVB 67	130518
Základní rám EVB 100	130858
Nástavec EVR 150	130481
Nástavec základního rámu EVA 64/50	130522
Nástavec základního rámu EVA 67/100	130526
Nástavec základního rámu EVA 100/50	130854
Nástavec základního rámu EVA 100/100	130856
Sloupek zábradlí EVP	130512
Konzola ECM 33	130378
Konzola ECM 67	130372
Konzola ECM 100	130365
Základní sloupek EVS 124	130619
Vertikální sloupek EVM 200	130621

PERI Nájemní kritéria

PERI UP Fasádní lešení Easy



















Rámy	Popis	Instrukce	Fakturace	Typ
	<p>33.25.12 Trn Spojení ohnuté</p> <ul style="list-style-type: none"> ■ zřetelné deformace 	 		
	<p>33.25.13 Ohnutá rozeta</p> <ul style="list-style-type: none"> ■ Je možné opravit ■ Prasklý svár ■ > 20 mm 	     	  	  

PERI Nájemní kritéria

PERI UP Fasádní lešení Easy



Rámy	Popis	Instrukce	Fakturace	Typ
	33.25.14 Ohnutý háček <ul style="list-style-type: none"> ■ Je možné opravit 			
	<ul style="list-style-type: none"> ■ Prasklina ve sváru nebo materiálu 			
	33.25.15 Ohnutá horizontála <ul style="list-style-type: none"> ■ $\varnothing \leq 3$ cm 			
	<ul style="list-style-type: none"> ■ prasklina 			
	<ul style="list-style-type: none"> ■ Hrana horizontály je poškozená 			

PERI Nájemní kritéria

PERI UP Fasádní lešení Easy



Podlaha se žebříkem EAW | Podlaha s průlezem EAW

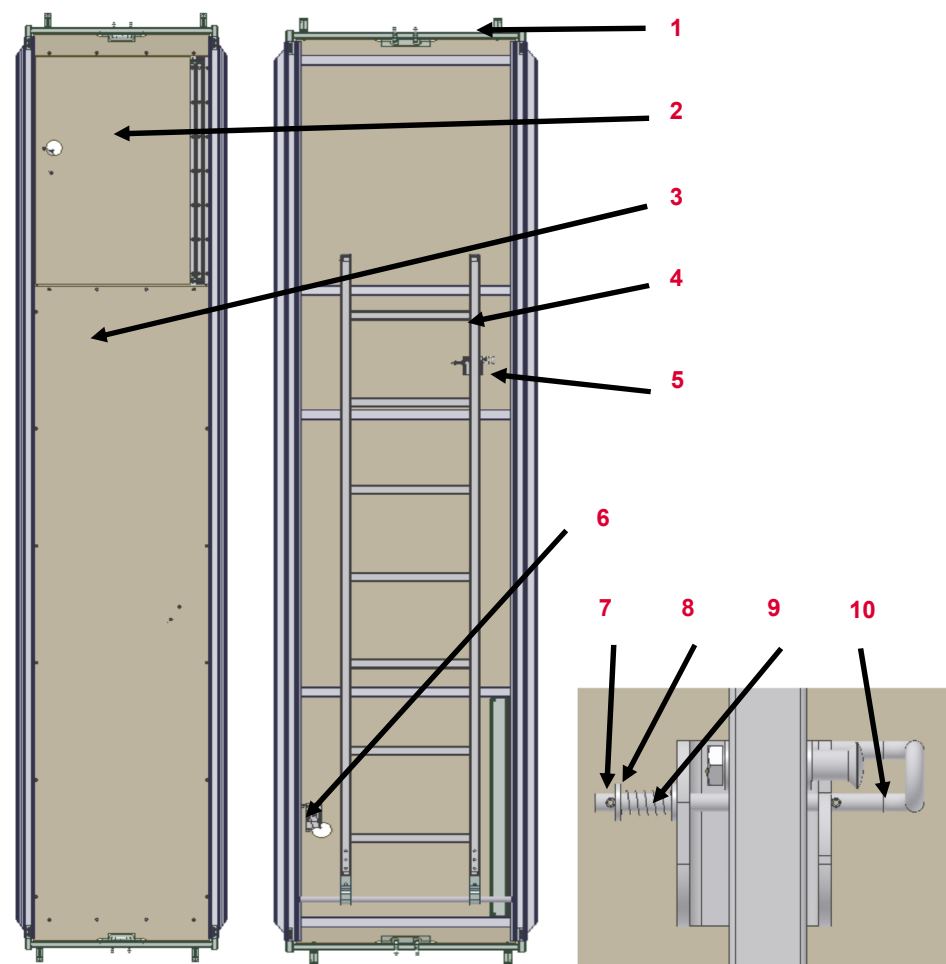













Č.	Popis	Číslo výrobku
1	Závěs	130308
2	Poklop	130412
3	Podlaha	
4	Žebřík EAL	130419
5	Držák žebříku	130423
6	Západka UAL	115566
7	Kolík	130356
8	Podložka	721633
9	Pružinka	130386
10	Bezpečnostní pojistka	130422

Platné pro:	Číslo výrobku
Podlaha se žebříkem EAW-L 250	130431
Podlaha se žebříkem EAW-L 300	130425
Podlaha s průlezem EAW 200	130426

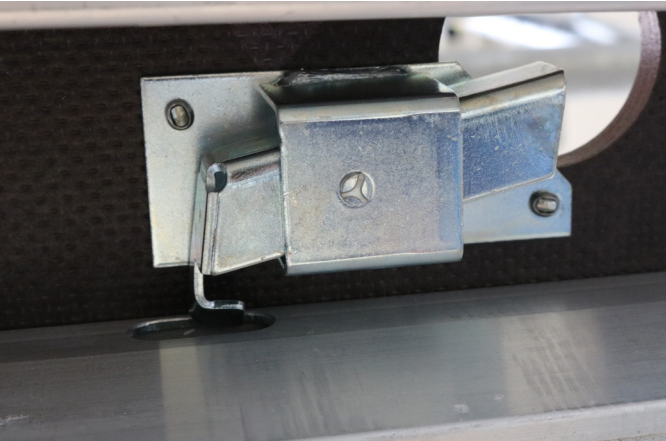
PERI Nájemní kritéria

PERI UP Fasádní lešení Easy























Podl. se žebříkem Podl. s průřezem EAW	Popis	Instrukce	Fakturace	Typ
	33.25.16 Podlaha			
	■ Opotřebovaná	 130412 (Poklop) 130407 (Podlaha EAW 300) 130427 (Podlaha EAW 250)		
	■ Poškozeno hrubou silou	 130412 (Poklop) 130407 (Podlaha EAW 300) 130427 (Podlaha EAW 250)		
	33.25.17 Západka nefukční			
	■ Opotřebovaná			
	■ Poškozeno hrubou silou			

PERI Nájemní kritéria

PERI UP Fasádní lešení Easy



Podl. se žebříkem Podl. s průřezem EAW	Popis	Instrukce	Fakturace	Typ
	<p>33.25.18 Držák žebříku</p> <ul style="list-style-type: none"> ■ Opotřebované a nefunkční ■ Nefunkční hrubým zacházením ■ Chybějící část 	<ul style="list-style-type: none">    	<ul style="list-style-type: none">    	<ul style="list-style-type: none">   
	<p>33.25.19 Ohnutá výztuha</p> <ul style="list-style-type: none"> ■ Možná oprava ■ Prasklý svár ■ Zkroucení 	<ul style="list-style-type: none">    	<ul style="list-style-type: none">    	<ul style="list-style-type: none">   

PERI Nájemní kritéria

PERI UP Fasádní lešení Easy

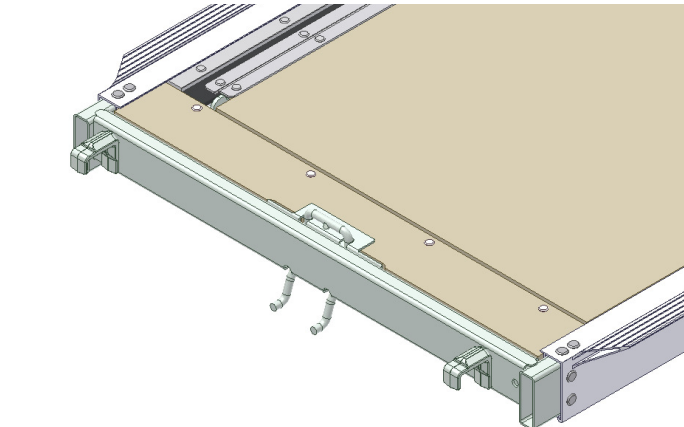

Podl. se žebříkem Podl. s průřezem EAW	Popis	Instrukce	Fakturace	Typ
	33.25.20 Ohnutý háček			
	■ ≤ 5 mm			
	■ > 5 mm			
	33.25.21 Závěs ohnutý nepoužitelný			
		130308 (Závěs) 722318 (Nýt 6,0 x 10)		
■ Prasklý háček				

PERI Nájemní kritéria

PERI UP Fasádní lešení Easy



Podlaha s průřezem EAW	Popis	Instrukce	Fakturace	Typ
	33.25.22 Ohnutý hák žebříku	<ul style="list-style-type: none"> Možná oprava 		
	<ul style="list-style-type: none"> Oprava není možná 	<ul style="list-style-type: none"> 130417 (Háček Easy) 104280 (Nýt 6,0x12) 		
	33.25.23 Ohnuté nášlapy žebříku	<ul style="list-style-type: none"> Bez prasklin ve sváru 		
	<ul style="list-style-type: none"> S prasklinami 			
	<ul style="list-style-type: none"> Zkroucení 			

PERI Nájemní kritéria

PERI UP Fasádní lešení Easy



Diagonála EBF

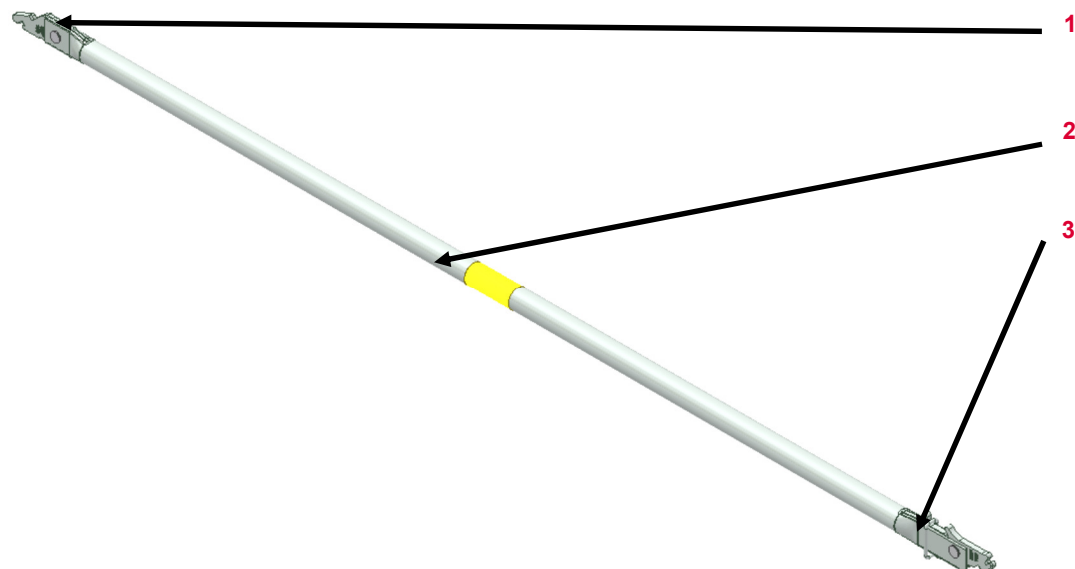











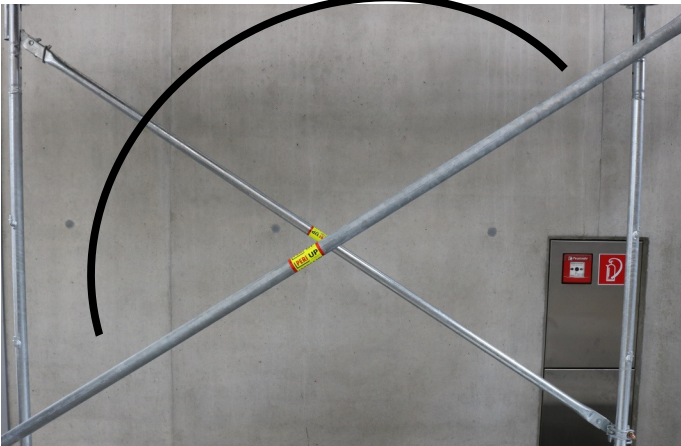

Č.	Popis	Číslo výrobku
1	Hlava diagonály dolní	
2	Trubka	
3	Hlava diagonály horní	

Platné pro:	Číslo výrobku
Diagonála EBF 150/200	130162
Diagonála EBF 200/200	130171
Diagonála EBF 250/200	130180
Diagonála EBF 300/200	130189

PERI Nájemní kritéria

PERI UP Fasádní lešení Easy



Diagonála EBF	Popis	Instrukce	Fakturace	Typ										
	33.25.24 Hlava diagonály nepoužitelná	 												
	33.25.25 Ohnutá diagonála <ul style="list-style-type: none"> ■ ≤ pov. ohnutí (L/500) ■ > pov. ohnutí (L/500) <table border="1"> <thead> <tr> <th>Výrobek</th> <th>Pov. ohnutí</th> </tr> </thead> <tbody> <tr> <td>Diagonála EBF 150/200</td> <td>4 mm</td> </tr> <tr> <td>Diagonála EBF 200/200</td> <td>5 mm</td> </tr> <tr> <td>Diagonála EBF 250/200</td> <td>6 mm</td> </tr> <tr> <td>Diagonála EBF 300/200</td> <td>7 mm</td> </tr> </tbody> </table>	Výrobek	Pov. ohnutí	Diagonála EBF 150/200	4 mm	Diagonála EBF 200/200	5 mm	Diagonála EBF 250/200	6 mm	Diagonála EBF 300/200	7 mm	<ul style="list-style-type: none">    	<ul style="list-style-type: none">   	<ul style="list-style-type: none">  
Výrobek	Pov. ohnutí													
Diagonála EBF 150/200	4 mm													
Diagonála EBF 200/200	5 mm													
Diagonála EBF 250/200	6 mm													
Diagonála EBF 300/200	7 mm													

PERI Nájemní kritéria

PERI UP Fasádní lešení Easy



Zábradlí EPG	Č.	Popis	Číslo výrobku
--------------	----	-------	---------------



- | | |
|---|----------|
| 1 | Koncovka |
| 2 | Trubka |

Gültig für	Číslo výrobku
Zábradlí EPG 67	130191
Zábradlí EPG 100	130193
Zábradlí EPG 150	130195
Zábradlí EPG 200	130197
Zábradlí EPG 250	130199
Zábradlí EPG 300	130201

PERI Nájemní kritéria

PERI UP Fasádní lešení Easy



Zábradlí EPG	Popis	Instrukce	Fakturace	Typ
--------------	-------	-----------	-----------	-----



33.25.26 Ohnutá koncovka

■ Oprava je možná



■ Není možná oprava



33.25.27 Ohnuté zábradlí

■ > pov. ohnutí (L/250)



Výrobek	Pov. ohnutí
Zábradlí EPG 67	3 mm
Zábradlí EPG 100	4 mm
Zábradlí EPG 150	6 mm
Zábradlí EPG 200	8 mm
Zábradlí EPG 250	10 mm
Zábradlí EPG 300	12 mm

PERI Nájemní kritéria

PERI UP Fasádní lešení Easy



Čelní zábradlí EPF	Č.	Popis	Číslo výrobku
--------------------	----	-------	---------------

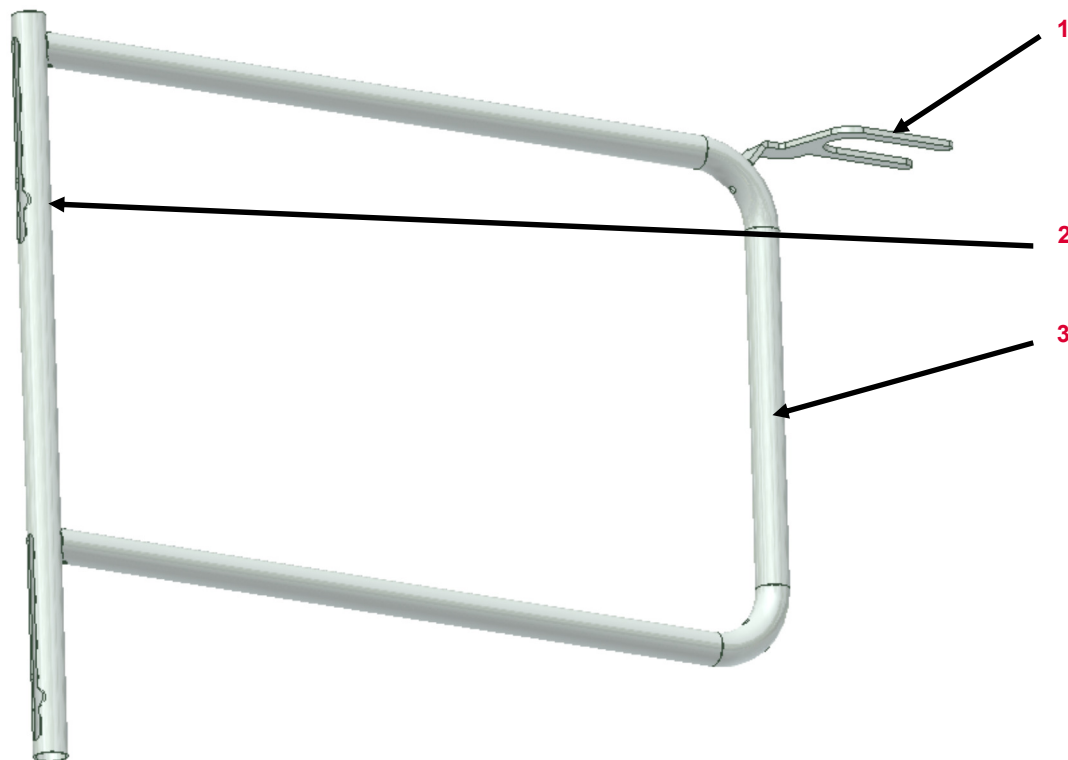













1	Vidlice
2	Trubka
3	Rám

PERI Nájemní kritéria

PERI UP Fasádní lešení Easy



Čelní zábradlí EPF	Popis	Instrukce	Fakturace	Typ
	33.25.28 Ohnutá vidlice	<ul style="list-style-type: none"> ■ Oprava je možná 		
	<ul style="list-style-type: none"> ■ Není možná oprava 			
	33.25.29 Rozmáčklá trubka	<ul style="list-style-type: none"> ■ Osazení je možné 		
	<ul style="list-style-type: none"> ■ Dále nepoužitelné 			

PERI Nájemní kritéria

PERI UP Fasádní lešení Easy





















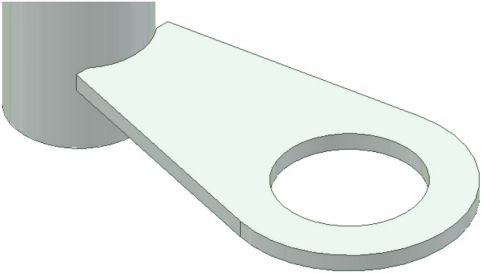

Držák ochranné stříšky EPC (130385)	Popis	Instrukce	Fakturace	Typ
	<p>33.25.30 Ohnuté připojení trubky rozmačkané</p> <ul style="list-style-type: none"> ■ Zřetelné poškození 			
	<p>33.25.31 Ohnutá trubka</p> <ul style="list-style-type: none"> ■ $\varnothing > 3 \text{ cm}$ ■ Hrana nepoškozena 			

PERI Nájemní kritéria

PERI UP Fasádní lešení Easy



Protection Panel Post EPS (130532)	Popis	Instrukce	Fakturace	Typ
	33.25.32 Ohnutý háček			
	<ul style="list-style-type: none"> ■ Oprava je možná ■ Není možná oprava 	  	 	 
	33.25.33 Ohnutý trn			
	<ul style="list-style-type: none"> ■ Zřetelné poškození 	 		
	33.25.34 Spojovací plech ohnutý			
	<ul style="list-style-type: none"> ■ Oprava je možná ■ Není možná oprava 	  	 	 

PERI Nájemní kritéria

PERI UP Fasádní lešení Easy



Spojka EWC (130964)	Popis	Instrukce	Fakturace	Typ
	33.25.35 Nefunkční závěs	<ul style="list-style-type: none"> ■ Opatřebovaná 		
	<ul style="list-style-type: none"> ■ Nefunkční hrubým zacházením 			
	33.25.36 Šroub Matice	<ul style="list-style-type: none"> ■ Chybějící 		
	<ul style="list-style-type: none"> ■ Poškozené 		131316 (Šroub) 710340 (Matice)	

PERI Nájemní kritéria

PERI UP Fasádní lešení Easy

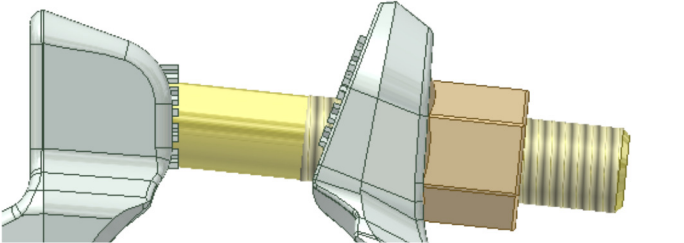
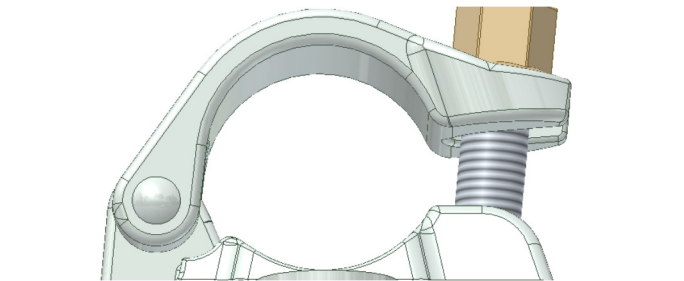

Spojka zábradlí EPR (130434)	Popis	Instrukce	Fakturace	Typ
	33.25.37 Ohnutý háček			
	<ul style="list-style-type: none"> ■ Oprava je možná 			
	33.25.38 Šroub Matice			
	<ul style="list-style-type: none"> ■ Chybějící 			
	33.25.39 Závěs not functional			
	<ul style="list-style-type: none"> ■ Opatřebovaná 			
	<ul style="list-style-type: none"> ■ Nefunkční hrubým zacházením 			

PERI Nájemní kritéria

Vysvětlivky znaků



Znak	Význam	Znak	Význam	Znak	Význam
	Není v pořádku – materiál je poškozený		Fakturuje se zákazníkovi		Optické poškození
	OK – materiál zůstává v nájemním skladu		Nefakturuje se zákazníkovi		Funkční poškození
	Poškozený materiál – není dovoleno vydávat materiál z bezpečnostních důvodů		Zkrácení prvku		Funkční poškození — není dovoleno vydávat materiál z bezpečnostních důvodů
	Oprava dle instrukcí		Označení prvku barvou		Statické poškození — není dovoleno vydávat materiál z bezpečnostních důvodů
	Oprava za studena — poté kontrola svárů a sousedních dílů		Výměna poškozeného dílu		
	Oprava po výpočtu hospodárnosti		Doplnění chybějícího dílu		
	Očištění materiálu				