

PERI Nájemní kritéria

Bednění VARIO GT 24

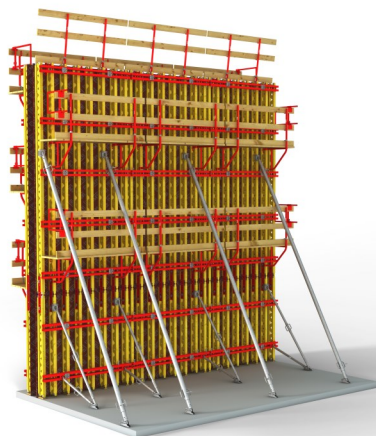

Kontakt
PERI, spol. s r.o.
bednění lešení služby

Průmyslova 392
252 42 Jesenice u Prahy
tel.: 222 359 311
info@peri.cz
www.peri.cz

Obsah	Str.	Provedené změny	Datum Iniciály	Str.
Panely VARIO	2	Nová verze	03/2020 fw	
Úchyt Pro Jeřáb 24	8	Přidáno ohnutí pro EKZ a AKZ	07/2022 fw	16
Jeřábový závěs 2 T / GT 24	11			
Spojky	14			
Betonářské konzole	17			
Napouštěcí Ventil BPA 2	20			
Vysvětlivky	22			

PERI Nájemní kritéria

Bednění VARIO GT 24



Panely VARIO	Číslo	Název	Číslo výrobku
--------------	-------	-------	---------------

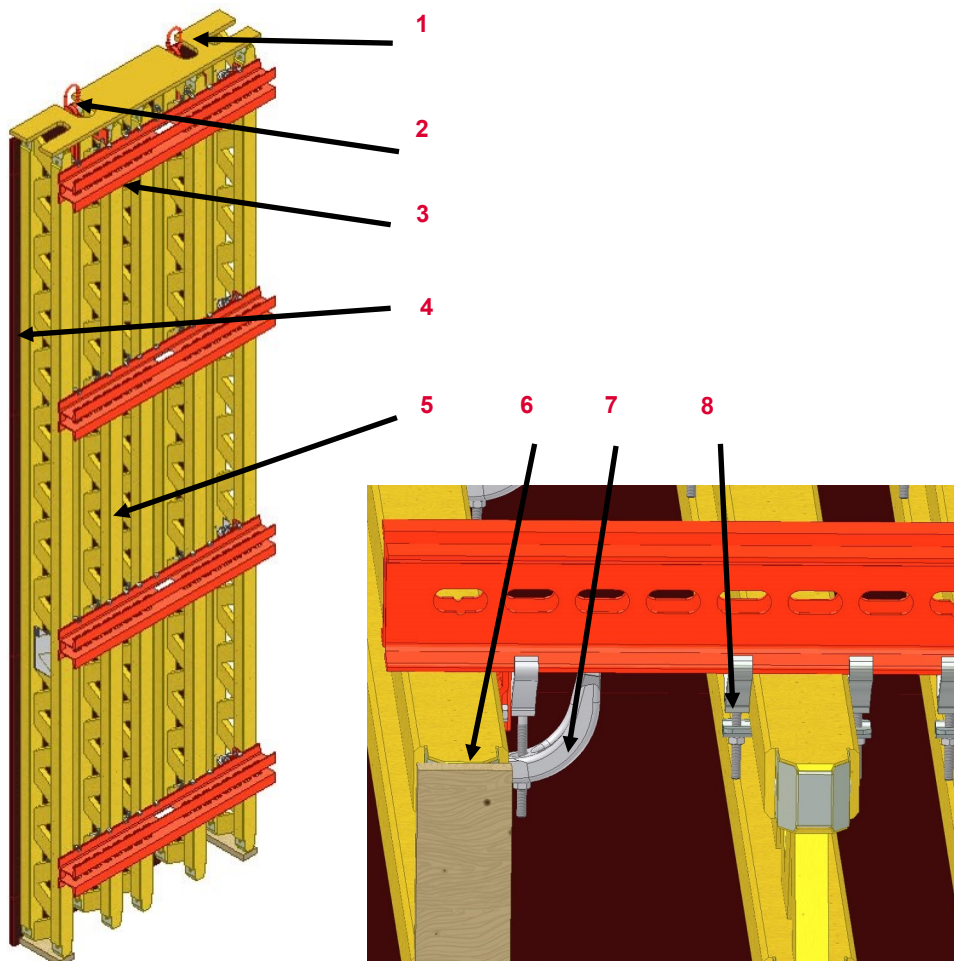

1	Úchyt pro jeřáb 24, pravý	021990
2	Úchyt pro jeřáb 24, levý	021980
3	Ocelová závora	
4	Dřevěná překližka	
5	Nosník	
6	Dřevěná zarážka	
7	Krajní spona HB	024600
8	Spona HB 24-100/120	024070

PERI Nájemní kritéria

Bednění VARIO GT 24



Výrobek	Číslo výrobku
Panel VARIO S 250 x 240	101241
Panel VARIO S 250 x 300	101242
Panel VARIO S 250 x 360	101243
Panel VARIO S 250 x 420	101244
Panel VARIO S 250 x 480	101245
Panel VARIO S 250 x 540	101246
Panel VARIO S 250 x 600	101247
Panel VARIO S 187.5 x 240	101248
Panel VARIO S 187.5 x 300	101249
Panel VARIO S 187.5 x 360	101250
Panel VARIO S 187.5 x 420	101251
Panel VARIO S 187.5 x 480	101252
Panel VARIO S 187.5 x 540	101253
Panel VARIO S 187.5 x 600	101254

Výrobek	Číslo výrobku
Panel VARIO S 125 x 240	101255
Panel VARIO S 125 x 300	101256
Panel VARIO S 125 x 360	101257
Panel VARIO S 125 x 420	101258
Panel VARIO S 125 x 480	101259
Panel VARIO S 125 x 540	101260
Panel VARIO S 125 x 600	101261
Panel VARIO S 100 x 240	101411
Panel VARIO S 100 x 300	101410
Panel VARIO S 100 x 360	101409
Panel VARIO S 100 x 420	101408
Panel VARIO S 100 x 480	101407
Panel VARIO S 100 x 540	101406
Panel VARIO S 100 x 600	101405

PERI Nájemní kritéria

Bednění VARIO GT 24



Výrobek	Číslo výrobku
Vnitřní Roh VARIO S 75/75 x 240	101471
Vnitřní Roh VARIO S 75/75 x 300	101470
Vnitřní Roh VARIO S 75/75 x 360	101469
Vnitřní Roh VARIO S 75/75 x 480	101467
Vnitřní Roh VARIO S 75/75 x 600	101465

Výrobek	Číslo výrobku

PERI Nájemní kritéria

Bednění VARIO GT 24















Panely VARIO	Popis	Instrukce	Fakturace	Typ
	Poškození Nosníků dle kritérií pro Nosníky GT 24			
	<ul style="list-style-type: none"> Nosník je dale použitelný 			
	<ul style="list-style-type: none"> Nosník již nelze dale použít 			
<ul style="list-style-type: none"> Více poškozených mosníků 				
	Poškození příhrad			
	<ul style="list-style-type: none"> ≤ 20 mm Vrchní 3 příhrady nejsou poškozeny 			
	<ul style="list-style-type: none"> ≤ 20 mm Vrchní 3 příhrady jsou poškozeny 		Otočte nosník	
<ul style="list-style-type: none"> > 20 mm 				

PERI Nájemní kritéria

Bednění VARIO GT 24



Panely VARIO	Popis	Instrukce	Fakturace	Typ
	<p>Poškození překližek je posuzováno dle kritérií pro Překližky</p>	<ul style="list-style-type: none"> ■ Lze opravit 		
	<ul style="list-style-type: none"> ■ Nelze opravit 			
	<p>Poškození Ocelových závor je posuzováno dle kritérií pro Ocelové závory</p>	<ul style="list-style-type: none"> ■ Stále použitelná závora 		
	<ul style="list-style-type: none"> ■ Závoru již nelze použít 			

PERI Nájemní kritéria

Bednění VARIO GT 24



Panely VARIO	Popis	Instrukce	Fakturace	Typ
	Dřevěná zarážka			
	■ Chybí			
	■ Je poškozená			
	Ochranná deska			
	■ Chybí			
	■ Je poškozená			

PERI Nájemní kritéria

Bednění VARIO GT 24



Úchyt pro jeřáb 24 (021990 | 021980)

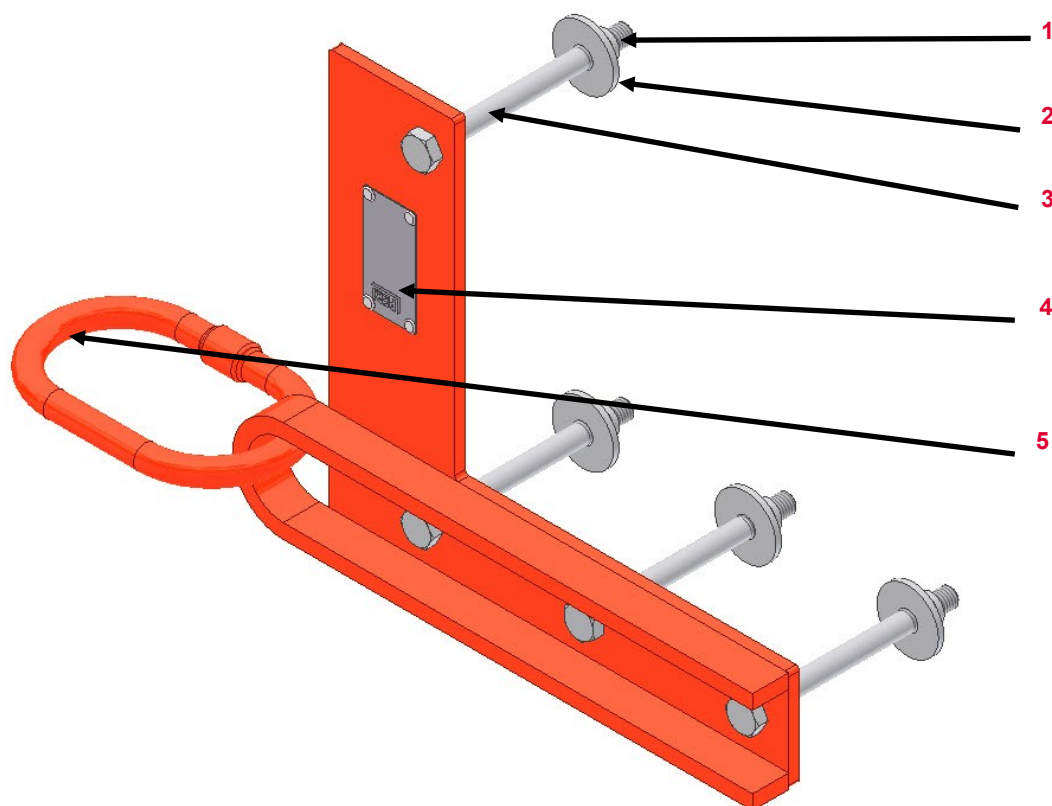

Číslo	Název	Číslo výrobku
1	Matice M 10	780356
2	Podložka R11	710139
3	Šroub M 10 x 110	710138
4	Typový štítek pravý	710762
4	Typový štítek levý	710761
5	Závěsné oko	

PERI Nájemní kritéria

Bednění VARIO GT 24



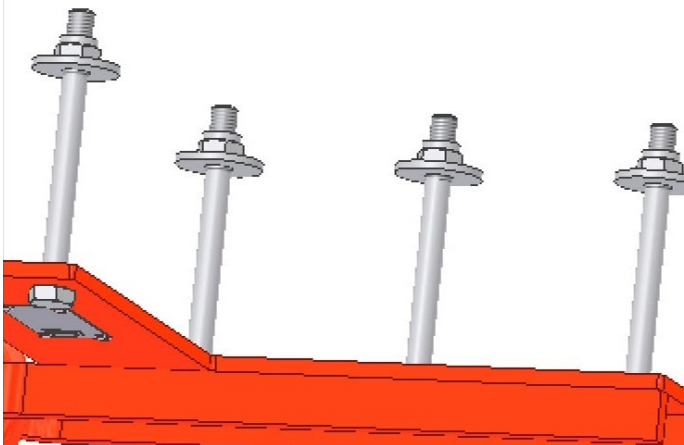
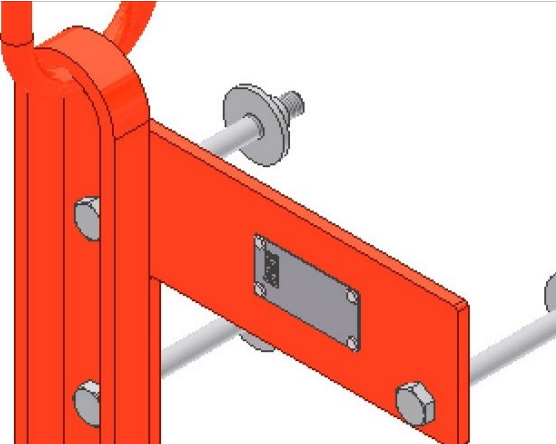







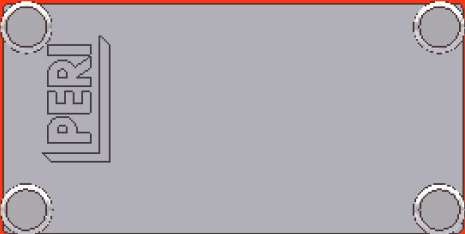





Úchyt pro jeřáb 24	Popis	Instrukce	Fakturace	Typ
	Šroub Matice			
	■ Chybí			
	■ Jsou poškozené			
	Ohnuté části			
	■ Lze opravit			
	■ Nelze opravit			
■ Praskliny v materiálu				

PERI Nájemní kritéria

Bednění VARIO GT 24



Úchyt pro jeřáb 24	Popis	Instrukce	Fakturace	Typ
	Typový štítek			
	<ul style="list-style-type: none"> ■ Nečitelný 			
	<ul style="list-style-type: none"> ■ Chybí 			
	Závěsné oko je opotřebované			
	<ul style="list-style-type: none"> ■ > Ø 11.7 mm 			
	<ul style="list-style-type: none"> ■ ≤ Ø 11.7 mm 			

PERI Nájemní kritéria

Bednění VARIO GT 24



Jeřabový Závěs 2T / GT 24 (111238)

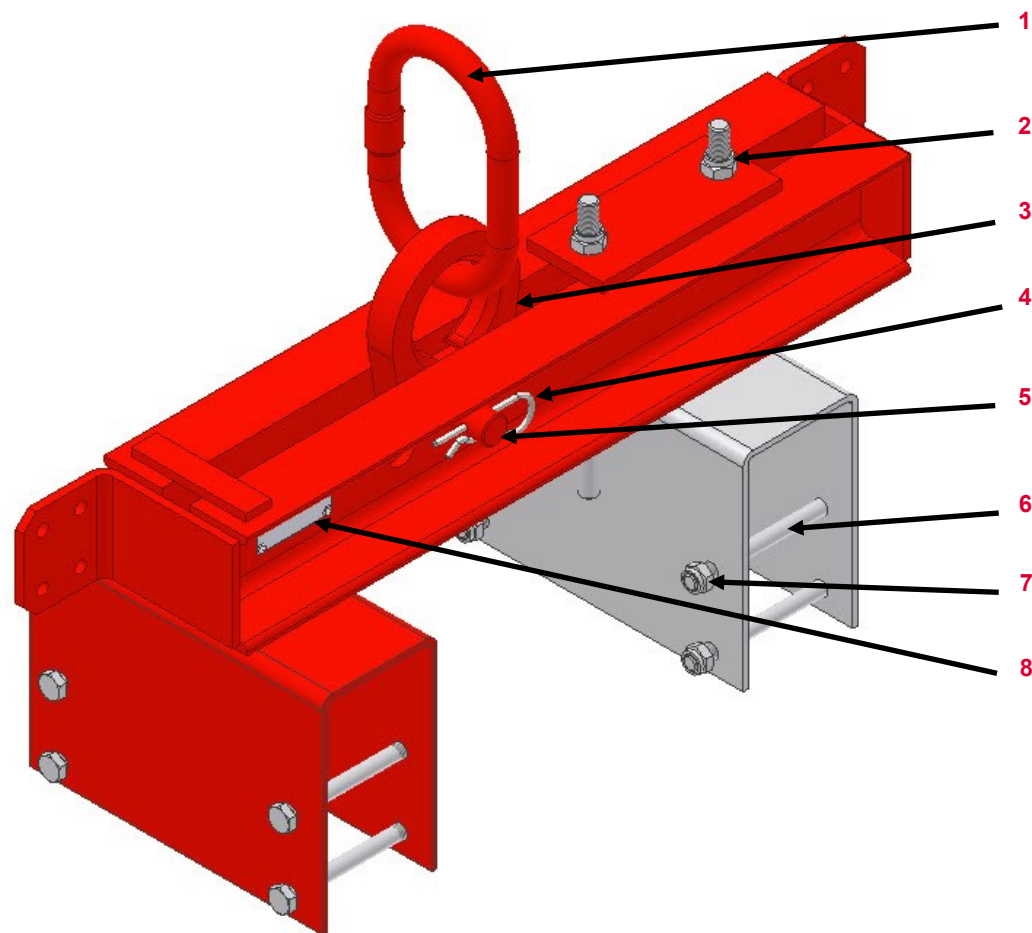

Číslo	Název	Číslo výrobku
1	Závěsné oko	
2	Matice M 12	710381
3	Oko pro jeřáb	111192
4	Závlačka	018060
5	Šroub 20 x 80	111222
6	Šroub M 10 x 110	710138
7	Matice M 10	780356
8	Typový štítek	111240

PERI Nájemní kritéria

Bednění VARIO GT 24



Jeřábový Závěs 2T / GT 24	Popis	Instrukce	Fakturace	Typ
---------------------------	-------	-----------	-----------	-----

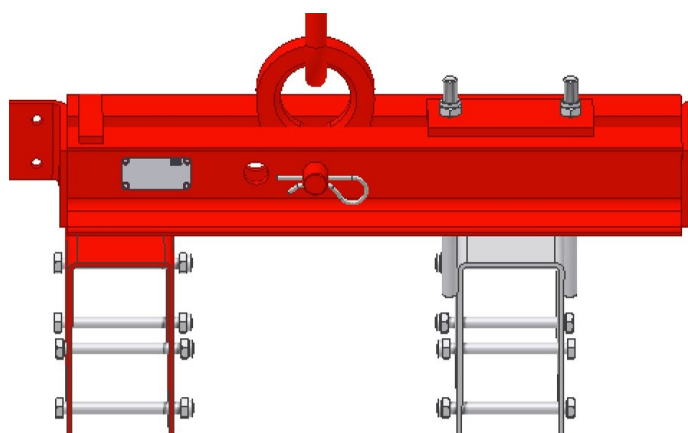

Šroub | Matice | Závlačka

■ Chybí



■ Jsou poškozené

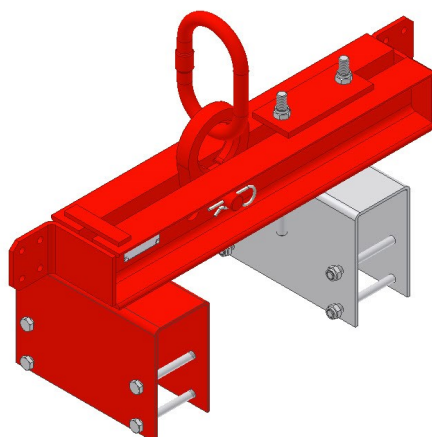

Ohnuté části

■ Lze opravit



■ Nelze opravit



■ Prasklý materiál



PERI Nájemní kritéria

Bednění VARIO GT 24



Jeřábový Závěs 2T / GT 24	Popis	Instrukce	Fakturace	Typ
---------------------------	-------	-----------	-----------	-----

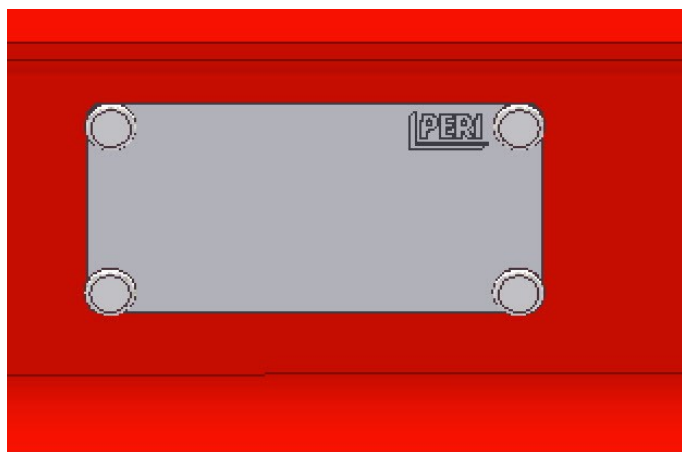

Typový štítek

- Nečitelný
- Chybí

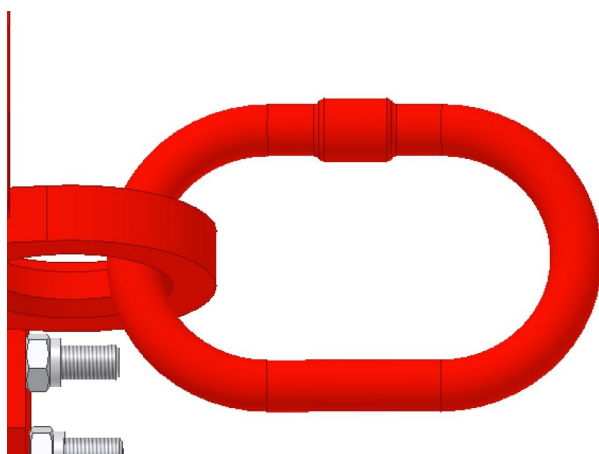

Závěsné Oko: opotřebenované | chybí

- $> \varnothing 11.7 \text{ mm}$
- $\leq 11.7 \text{ mm}$
- Chybí



PERI Nájemní kritéria

Bednění VARIO GT 24



Spojky	Číslo	Název	Číslo výrobku
--------	-------	-------	---------------

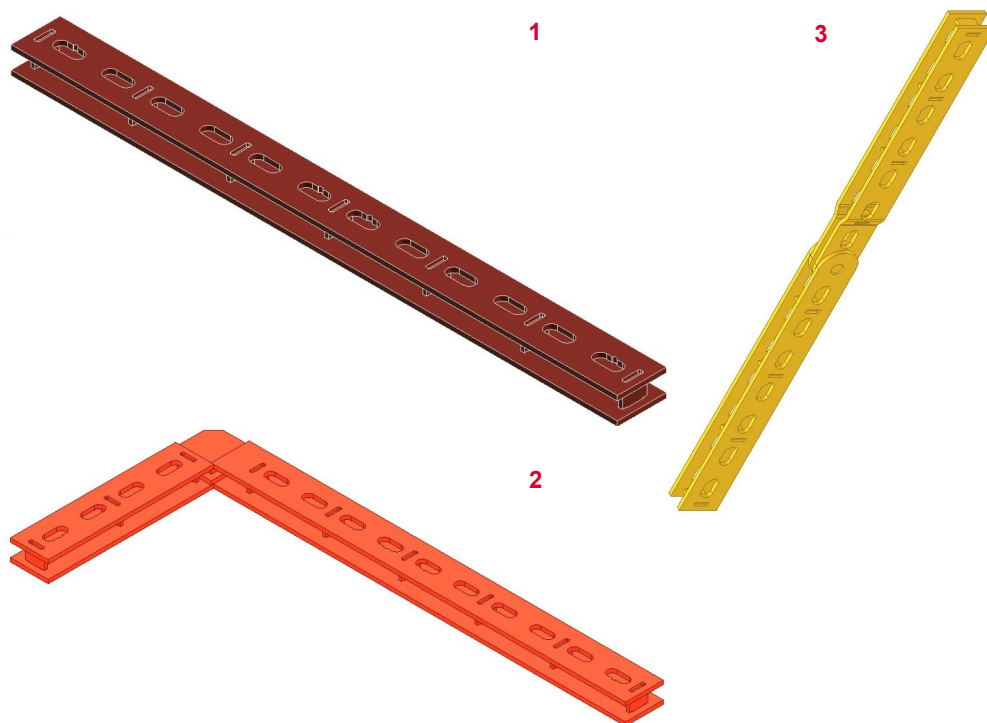

1	Spojka
2	Rohová Spojka
3	Kloubová Spojka

Platné pro:	Číslo výrobku
Spojka VKZ 99	013010
Spojka VKZ 147	013020
Spojka VKZ 211	013030
Mimoosá Spojka VVKZ 3/99	101395
Rohová Spojka EKZ 95/43	013140
Rohová Spojka EKZ 76/76	013130
Rohová Spojka EKZ 47/43	103938
Spojka Vnějšího Rohu AKZ 85/85	103850
Kloubová Spojka GKZ 60/60	013220
Kloubová Spojka GKZ 76/76	013210
Spojka VKS 99 Pohledový Beton	102825
Kloubová Spojka GKS 60/60 VARIO	103054

PERI Nájemní kritéria

Bednění VARIO GT 24



















Spojky	Popis	Instrukce	Fakturace	Typ
	Ohnutí	<ul style="list-style-type: none"> ■ $\leq 6\text{mm (l/300)}$ a stále zaručena funkčnost 		
	<ul style="list-style-type: none"> ■ Nelze opravit 			
	<ul style="list-style-type: none"> ■ Oprava není ekonomicky výhodná 			
	Rez	<ul style="list-style-type: none"> ■ Stupeň koroze \leq třída C 		
	<ul style="list-style-type: none"> ■ Stupeň koroze $>$ třída C 			

PERI Nájemní kritéria

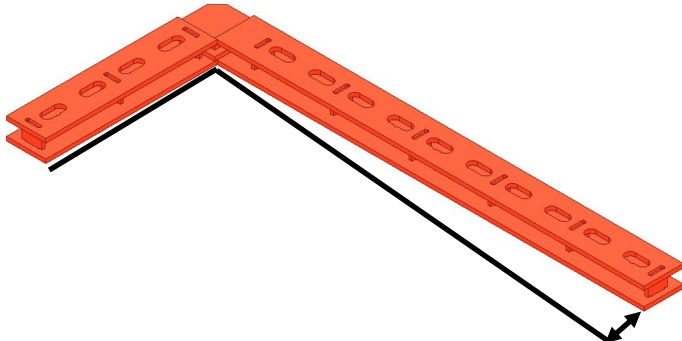
Bednění VARIO GT 24



Spojka	Popis	Instrukce	Fakturace	Typ
	Prasklý svár			
	<ul style="list-style-type: none"> ■ Lze opravit 			
	<ul style="list-style-type: none"> ■ Nelze 	 		
	<ul style="list-style-type: none"> ■ Oprava je ekonomicky nevýhodná 	 		
	Rohová Spojka EKZ / AKZ ohnutí	 		
	<ul style="list-style-type: none"> ■ > 5 mm na 1m 			

PERI Nájemní kritéria

Bednění VARIO GT 24



Bednicí konzole	Číslo	Název	Číslo výrobku
-----------------	-------	-------	---------------

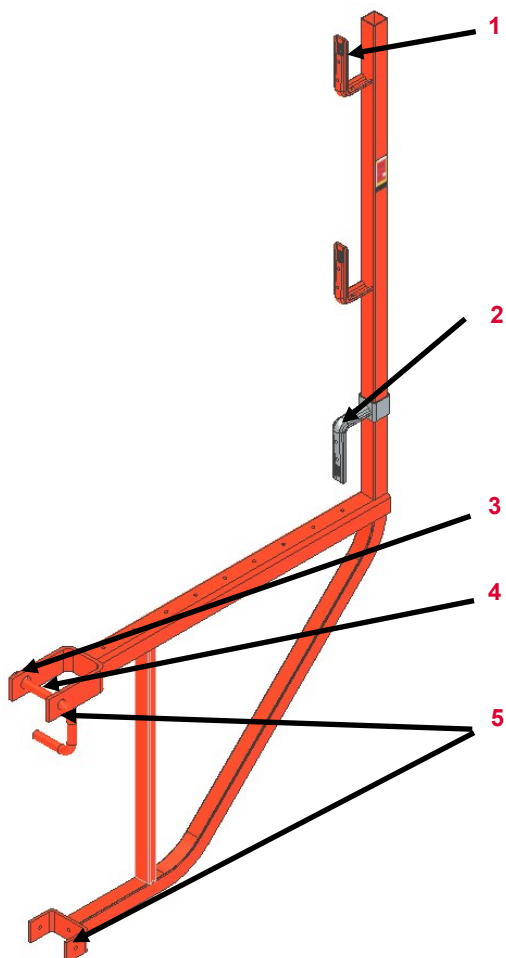

1	Úhelník 65X120 Pro TRG	115543
2	Posuvný Držák Sloupku	115673
3	Podložka	780701
4	Třmen	703603
5	Připojení	

Platné pro	Číslo výrobku
Konzola Pro Betonáž GB 80	027110
Rohová Konzola EGB 24-80, Pravá	027060
Rohová Konzola EGB 24-80, Levá	027070

PERI Nájemní kritéria

Bednění VARIO GT 24



Bednicí konzole	Popis	Instrukce	Fakturace	Typ
	Posuvný Držák Sloupku			
	<ul style="list-style-type: none"> ■ Chybí 			
<ul style="list-style-type: none"> ■ Je poškozený 	Úhelník 65X120 Pro TRG je ohnutý			
<ul style="list-style-type: none"> ■ ≤ 20 mm 	<ul style="list-style-type: none"> ■ > 20 mm 			
	<ul style="list-style-type: none"> ■ ≤ 20 mm 			
	<ul style="list-style-type: none"> ■ > 20 mm 			

PERI Nájemní kritéria

Bednění VARIO GT 24



Bednicí konzole	Popis	Instrukce	Fakturace	Typ
	Prasklý svár			
	■ S poškozením okolního profilu			
	■ Bez poškození okolního profilu			
	Ohnuté části			
	■ $\leq 5^\circ$			
	■ $> 5^\circ$			

PERI Nájemní kritéria

Bednění VARIO GT 24



Napouštěcí Ventil BPA 2 (115009)

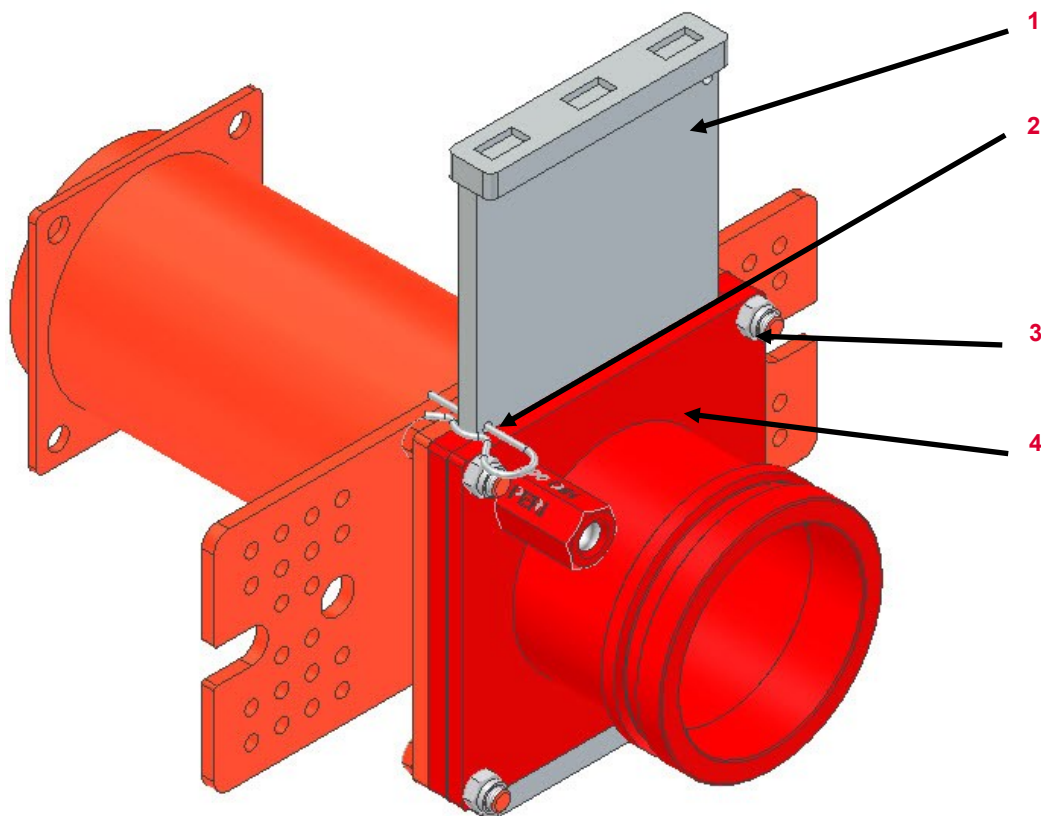

Číslo	Název	Číslo výrobku
1	Posuvný uzávěr	113463
2	Závlačka 4/1	018060
3	Matice	710381
4	Krycí plech	114786

PERI Nájemní kritéria

Bednění VARIO GT 24









Napouštěcí Ventil BPA 2 (115009)	Popis	Instrukce	Fakturace	Typ
	Posuvný uzávěr			
	<ul style="list-style-type: none"> ■ Chybí 			
	<ul style="list-style-type: none"> ■ Ohnutý nebo jinak poškozený 			
	Ohnuté připojení			
	<ul style="list-style-type: none"> ■ Pumpu je možné připojit 			
	<ul style="list-style-type: none"> ■ Připojení není možné 			

PERI Nájemní kritéria

Vysvětlivky znaků



Znak	Význam	Znak	Význam	Znak	Význam
	Není v pořádku – materiál je poškozený		Fakturuje se zákazníkovi		Optické poškození
	OK – materiál zůstává v nájemním skladu		Nefakturuje se zákazníkovi		Funkční poškození
	Poškozený materiál – není dovoleno vydávat materiál z bezpečnostních důvodů		Zkrácení prvku		Funkční poškození — není dovoleno vydávat materiál z bezpečnostních důvodů
	Oprava dle instrukcí		Označení prvku barvou		Statické poškození — není dovoleno vydávat materiál z bezpečnostních důvodů
	Oprava za studena — poté kontrola svárů a sousedních dílů		Výměna poškozeného dílu		
	Oprava po výpočtu hospodárnosti		Doplnění chybějícího dílu		
	Očištění materiálu				