

PERI Nájemní kritéria

PERI UP Schodiště



Kontakt

PERI, spol. s r.o.
bednění lešení služby

Průmyslová 392
252 42 Jesenice u Prahy
tel.: 222 359 311
info@peri.cz
www.peri.cz

Obsah	Strana	Změny	Datum Iniciály	Strana
Schodiště	2	Nová verze	06/2017 fw	
Schodišťové stupně	7			
Schodišťové nosníky	10			
Zábradlí	13			
Nosič sloupků Koncový nosič	18			
Horizontála se sponou	20			
Podestová výztuha	24			
Ocelové podlahy	25			
Vysvětlivky	33			

PERI Nájemní kritéria

PERI UP Schodiště



Schodiště UAS

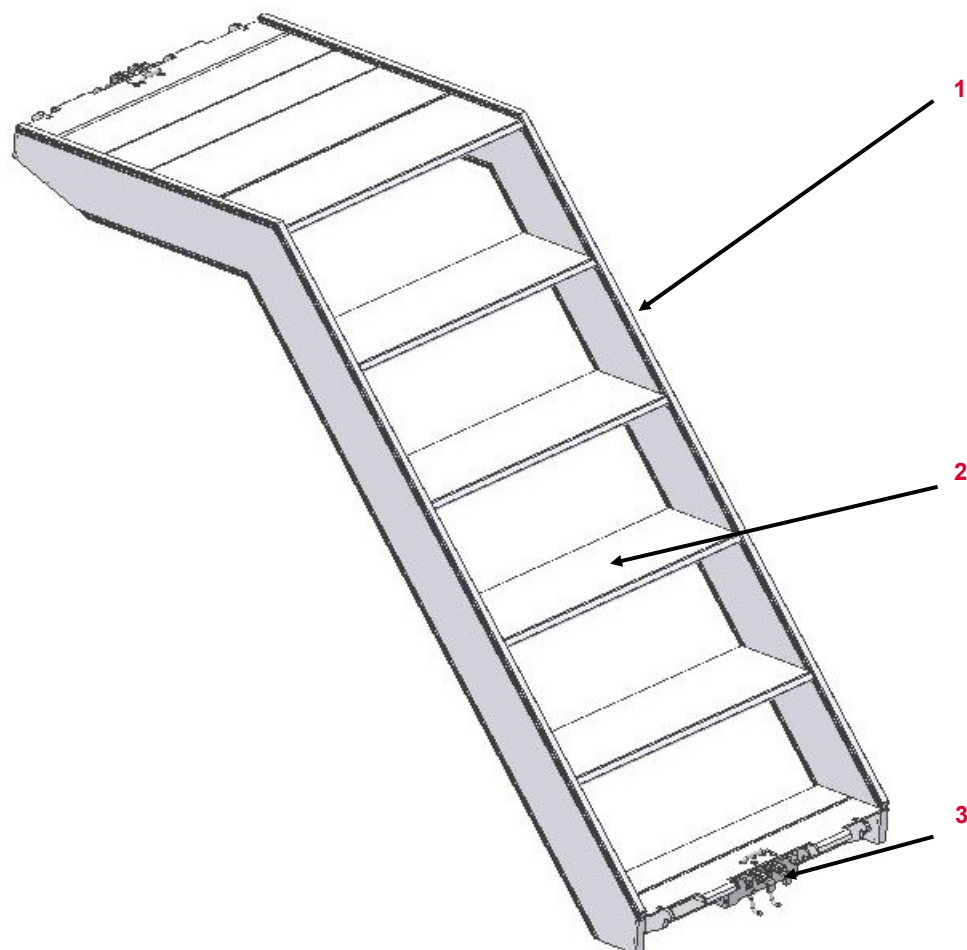

Č.	Popis	Katalogové číslo
1	Postranní profil	
2	Schody	
3	Spojovací vzpěra	



Platí pro

Schodiště UAS 250/200	100737
Schodiště UAS 300/200	100738
Schodiště UAS 75x75/50	113228
Schodiště UAS 75x150/50 T	111087
Schodiště UAS 75x150/50 S	111095
Schodiště UAS 75x150/100	111103
Schodiště UAS 75x150/100 S	114536
Schodiště UAS 75x250/200	111117
Schodiště UAS 75X300/200	111124

PERI Nájemní kritéria

PERI UP Schodiště

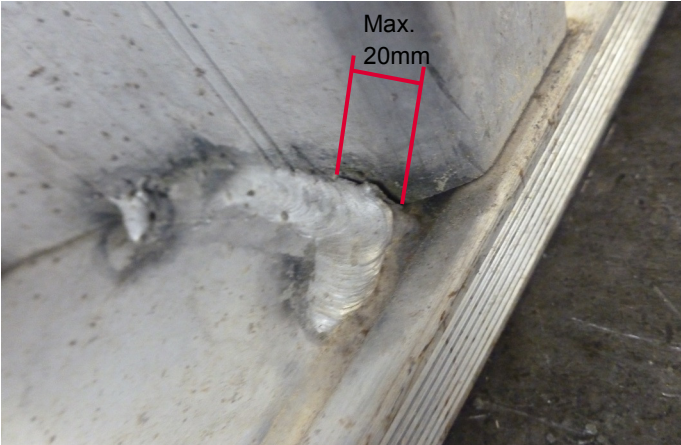









Schodiště UAS	Popis	Pokyny	Fakturace	Typ
	33.30.01 Prasklina vedle sváru			
	<ul style="list-style-type: none"> ■ < 20 mm ■ > 20 mm 	<ul style="list-style-type: none"> 	<ul style="list-style-type: none"> 	<ul style="list-style-type: none">
	33.30.02 Prasklina ve sváru			

PERI Nájemní kritéria

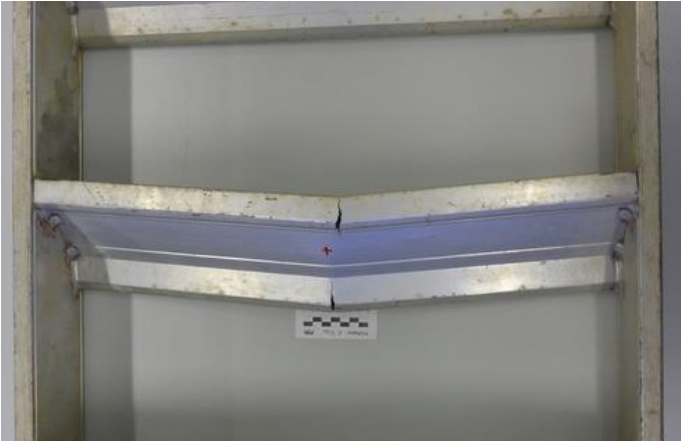
PERI UP Schodiště













Schodiště UAS	Popis	Pokyny	Fakturace	Typ
	33.30.03 Prasklina v základně (Vylomený stupeň)	 		
	33.30.04 Prasklý stupeň	 		

PERI Nájemní kritéria

PERI UP Schodiště





Schodiště UAS	Popis	Pokyny	Fakturace	Typ
	33.30.05 Místní deformace na začátku konci schodiště	 		
	33.30.06 Promáčkliny v postranním profilu <ul style="list-style-type: none">■ Bez prasklin v materiálu nebo sváru	 		

PERI Nájemní kritéria

PERI UP Schodiště



Schodišťové nosníky UA (114731 109219)	Popis	Pokyny	Fakturace	Typ
	33.30.07 Ohnutý závěs			
	<ul style="list-style-type: none"> ■ Pokud možno 			
	<ul style="list-style-type: none"> ■ Nebo pokud nadále není možno 			
<ul style="list-style-type: none"> ■ Nebo pokud zlomeno 				
	33.30.08 Promáčkliny v profilu			
	<ul style="list-style-type: none"> ■ $\leq \text{Ø } 3 \text{ cm}$ a hrany nejsou poškozeny 			
	<ul style="list-style-type: none"> ■ Nebo $> \text{Ø } 3 \text{ cm}$ 			
<ul style="list-style-type: none"> ■ Nebo poškozené hrany 				

PERI Nájemní kritéria

PERI UP Schodiště



Schodišťový stupeň

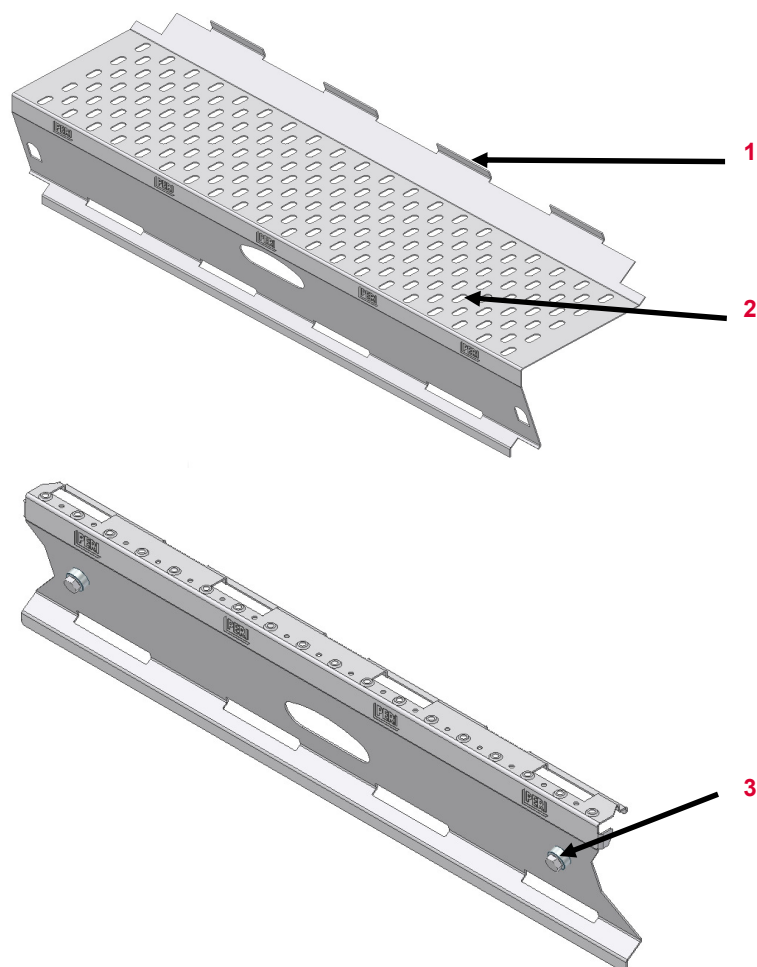

Č.	Popis	Katalogové číslo
1	Spojovací vzpěra	
2	Profil	
3	Šestihranný šroub M 12x35	780156

















Platí pro

Schodišťový stupeň UAR 100	109198
Schodišťový stupeň UAR 125	114621
Koncový stupeň UAE 100	109208
Koncový stupeň UAE 125	114180

PERI Nájemní kritéria

PERI UP Schodiště













Schodišťový stupeň	Popis	Pokyny	Fakturace	Typ
	33.30.09 Spojovací vzpěra ohnutá			
	<ul style="list-style-type: none"> ■ Spojení možné 	 		
	<ul style="list-style-type: none"> ■ Nebo spojení již není možné 			
	<ul style="list-style-type: none"> ■ Nebo srovnání již není možné 	 		
	33.30.10 Chybějící šroub			

PERI Nájemní kritéria

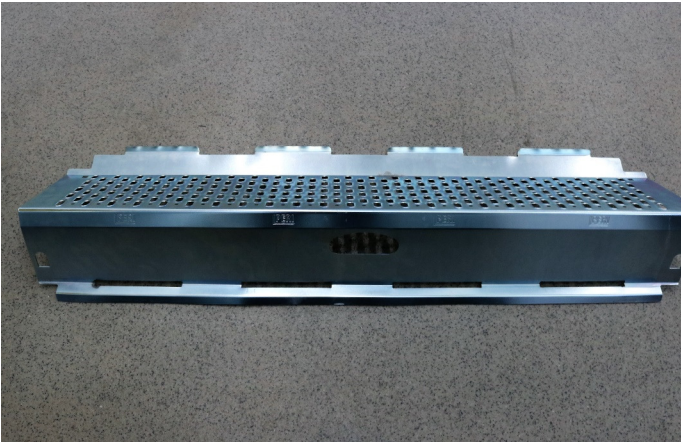
PERI UP Schodiště



Schodišťový stupeň	Popis	Pokyny	Fakturace	Typ
	33.30.11 Ohnutý			
	<ul style="list-style-type: none"> ■ Pokud možno ■ Nebo pokud nadále nepoužitelné 	 	 	 
	33.30.12 Stupeň ohnutý roztržený			

PERI Nájemní kritéria

PERI UP Schodiště



Schodišťové nosníky UZS

Č. Popis Katalogové číslo

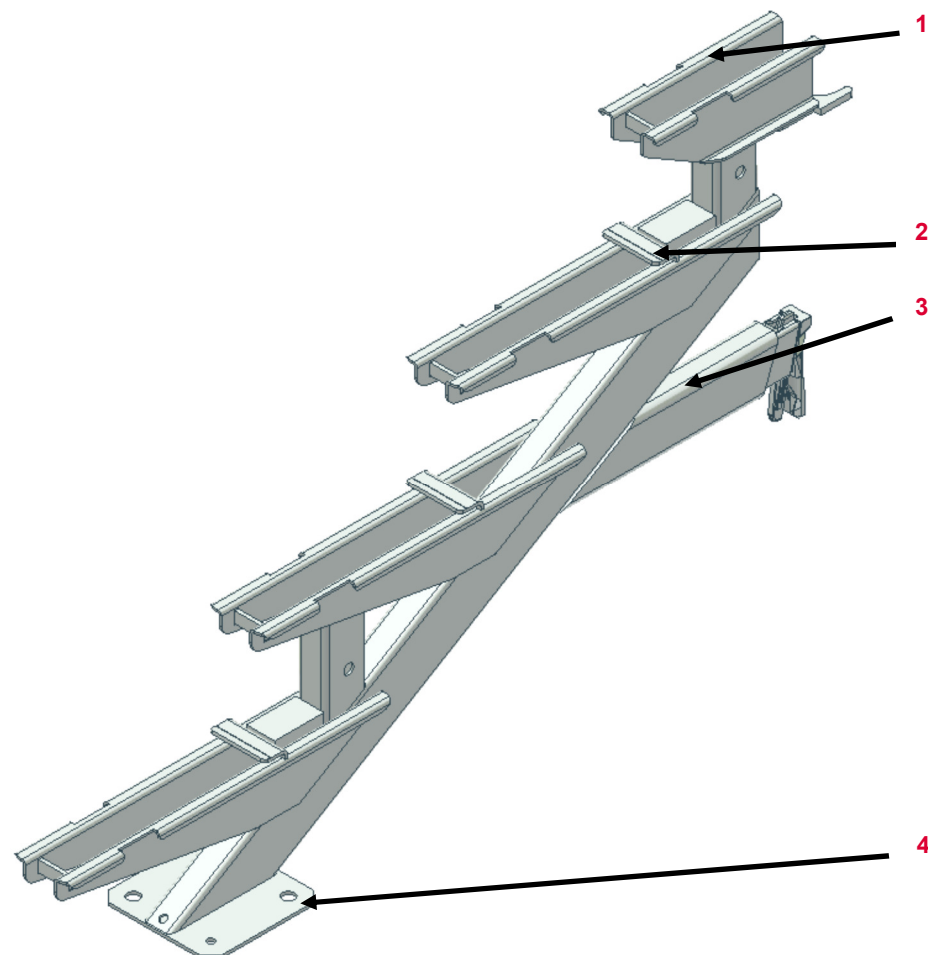

- | | |
|---|-----------------|
| 1 | Stupňový profil |
| 2 | Podpěrka |
| 3 | Připojení |
| 4 | Koncová patka |











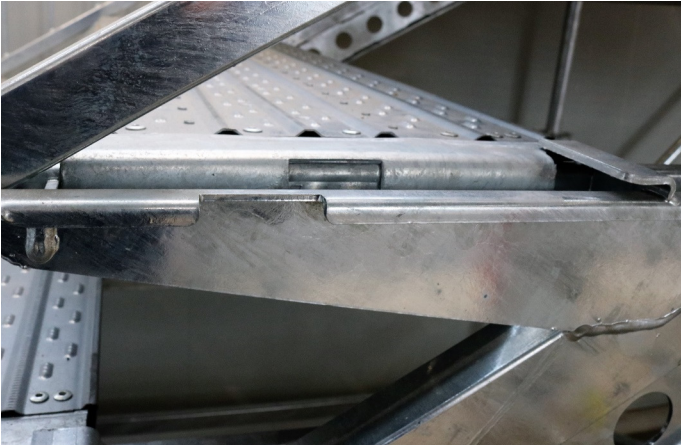







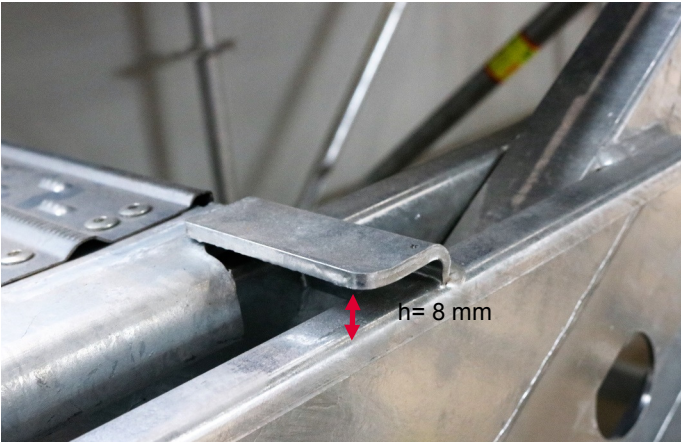

Platí pro

Schodišťové nosníky UZS 28/27	110258
Schodišťové nosníky UZS 56/50	110242
Schodišťové nosníky UZS 110/83	110249
Schodišťové nosníky UZS 250/150	107448

PERI Nájemní kritéria

PERI UP Schodiště















Schodišťové nosníky UZS	Popis	Pokyny	Fakturace	Typ
	33.30.13 Stupňový profil ohnutý			
	<ul style="list-style-type: none"> ■ Osazení možné 	 		
	<ul style="list-style-type: none"> ■ Nebo pokud narovnění možné 	 		
<ul style="list-style-type: none"> ■ Nebo pokud narovnění není možné 	 			
 <p>h= 8 mm</p>	33.30.14 Podpěrka ohnutá			
	<ul style="list-style-type: none"> ■ Pokud možno 	 		
<ul style="list-style-type: none"> ■ Nebo pokud nadále nepoužitelné 	 			

PERI Nájemní kritéria

PERI UP Schodiště



Schodišťové nosníky UZS	Popis	Pokyny	Fakturace	Typ
	33.30.15 Koncová patka ohnutá			
	<ul style="list-style-type: none"> ■ Pokud možno ■ Pokud je svár prasklý 	  	 	 
	33.30.16 Klín chybí	 		

Schodišťové zábradlí Podestové zábradlí Zábradlový rám	Č.	Popis	Katalogové číslo
--	----	-------	------------------

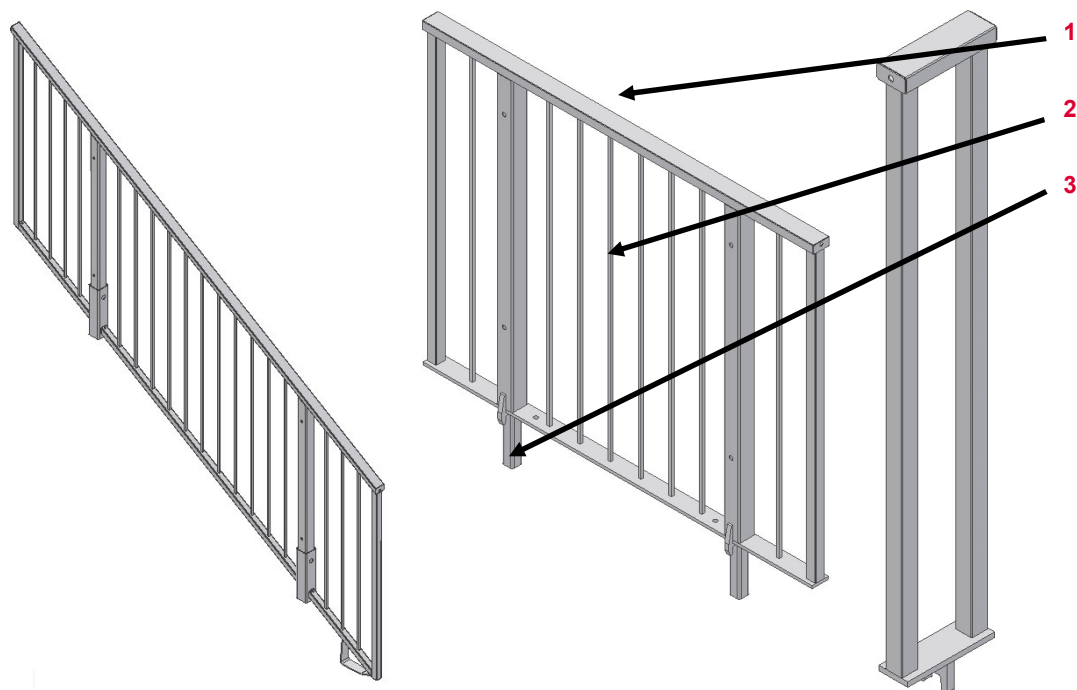

- | | |
|---|------------------|
| 1 | Zábradlí |
| 2 | Rozpěra |
| 3 | Spojovací vzpěra |



















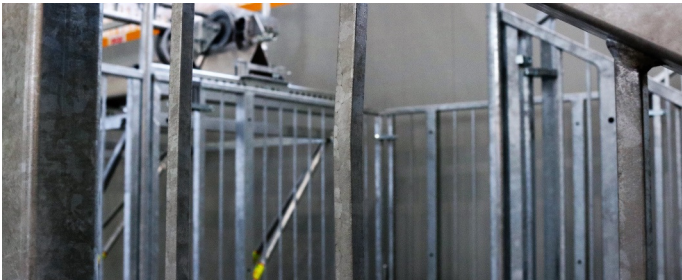



Platí pro

Schodišťové zábradlí UZG 56/50	110263
Schodišťové zábradlí UZG 110/83	110270
Schodišťové zábradlí UZG 250/150	108189
Podestové zábradlí UZG 150	108190
Zábradlový rám UZG 25	108545

PERI Nájemní kritéria

PERI UP Schodiště















Zábradlí	Popis	Pokyny	Fakturace	Typ
	33.30.17 Připojení pro Zábradlový sloupek ohnuté			
	<ul style="list-style-type: none"> ■ Vložení možné ■ Nebo pokud není možné 	  	 	 
	33.30.18 Rozpěra ohnutá			
	<ul style="list-style-type: none"> ■ Nepoškozený svár ■ Nebo s poškozeným svárem 	 	 	 
	33.30.19 Schodišťové zábradlí ohnuté			
	<ul style="list-style-type: none"> ■ < povolené ohnutí (L/250) ■ Nebo > 5 mm (110/83) 	 	 	 

PERI Nájemní kritéria

PERI UP Schodiště











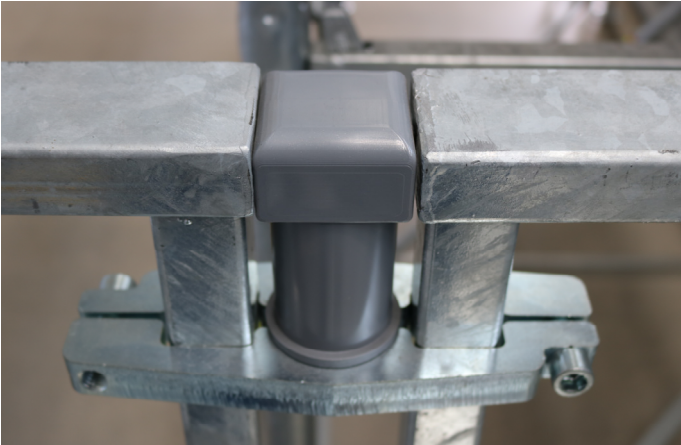









Zábradlová Spojka (108387;108218)	Popis	Pokyny	Fakturace	Typ
	33.30.20 Šroub IMBUS M12 <ul style="list-style-type: none"> ■ Chybějící ■ Zničený (nepohyblivý) špatným zacházením 	 	 	 
	33.30.21 Ohnutá <ul style="list-style-type: none"> ■ Zábradlí jsou spojitelná ■ Zábradlí nejsou spojitelná 	 	 	 

PERI Nájemní kritéria

PERI UP Schodiště















Přechod zábradlí	Popis	Pokyny	Fakturace	Typ
	33.30.22 Části přechodu zábradlí vylomené			
	<ul style="list-style-type: none"> ■ Bez rizika zranění 			
	<ul style="list-style-type: none"> ■ Riziko zranění kvůli ostrým hranám 			
	<ul style="list-style-type: none"> ■ Viditelně nepoužitelné 			
	33.30.23 Části trubky vylomené			
	<ul style="list-style-type: none"> ■ Nasazení možné 			
	<ul style="list-style-type: none"> ■ Nebo pokud nadále nepoužitelné 	 		

PERI Nájemní kritéria

PERI UP Schodiště



Schodišťové zábradlí UAG | UAH (100742, 100830)

	Popis	Pokyny	Fakturace	Typ
	33.30.24 Zábradlí ohnuté		 088244	
	33.30.25 Vidlice ohnutá či rezavá	 Odrezit a zabarvit, narovnat	 088244	
	33.30.26 Chybějící třmen závěsu	 100826 (Třmen UAH)		

PERI Nájemní kritéria

PERI UP Schodiště



Nosič sloupků Koncový nosič	Č.	Popis	Katalogové číslo
-------------------------------	----	-------	------------------

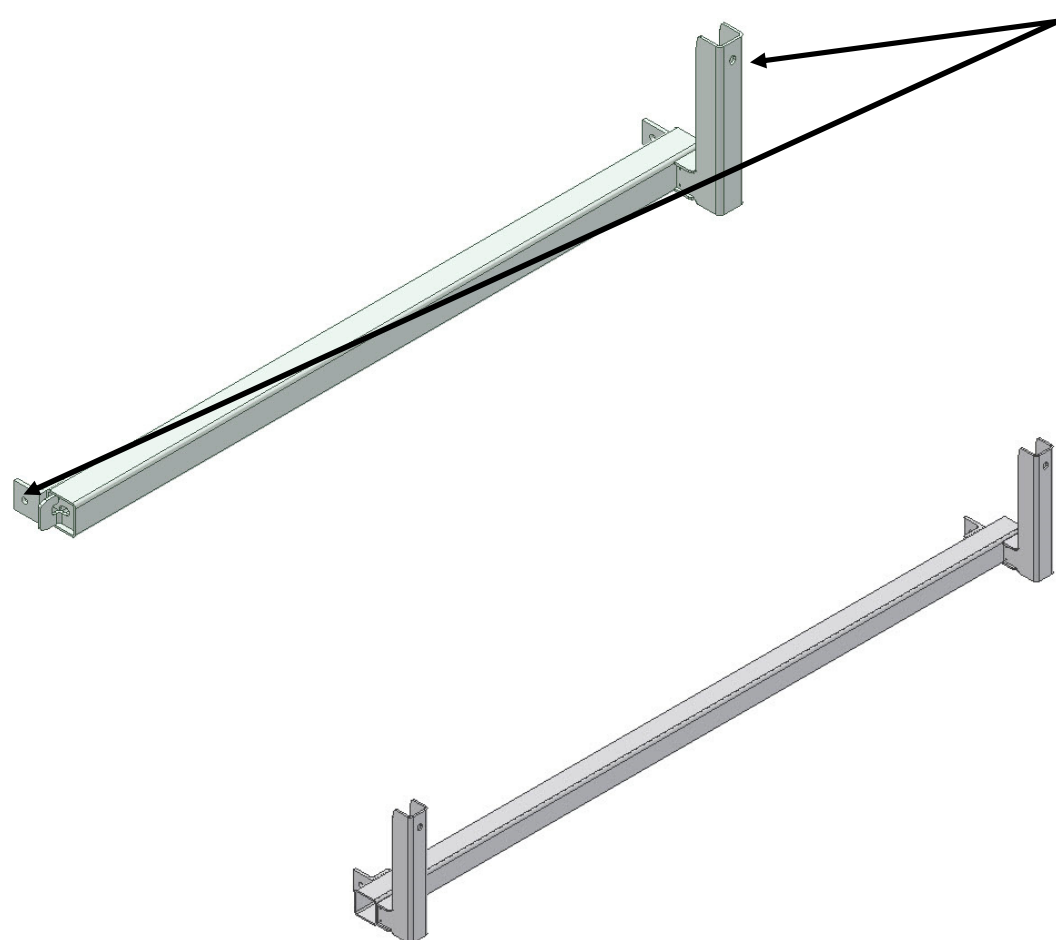













1	1	Připojní	127402
2	2	Horizontální profil	

Platí pro	
Nosič sloupků UZF 150	107162
Nosič sloupků UZF 200	106582
Nosič sloupků UZF 250	106583
Koncový nosič UZE 150	108536
Koncový nosič UZE 200	107178
Koncový nosič UZE 250	108544

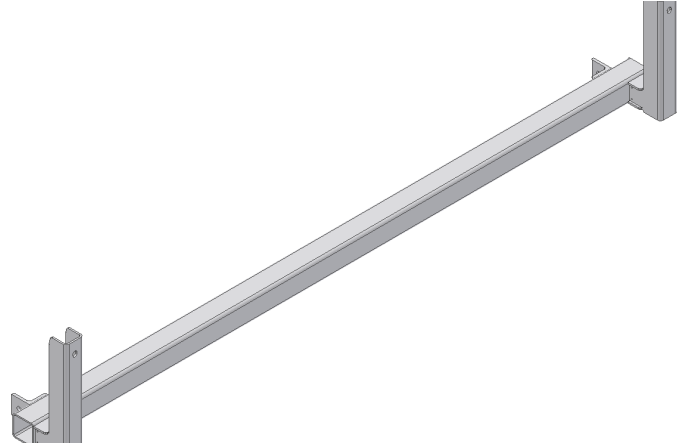
PERI Nájemní kritéria

PERI UP Schodiště











Nosič sloupků Koncový nosič	Popis	Pokyny	Fakturace	Typ
	33.30.27 Připojení ohnuté	<ul style="list-style-type: none"> ■ Pokud možno  		
	<ul style="list-style-type: none"> ■ Nebo pokud nadále nepoužitelné 			
	33.30.28 Horizontální profil ohnutý	<ul style="list-style-type: none"> ■ Vložení do schodišťového zábradlí možné  		
	<ul style="list-style-type: none"> ■ Nebo vložení není možné 			

PERI Nájemní kritéria

PERI UP Schodiště



Horizontála se sponou (106626)	Popis	Pokyny	Fakturace	Typ
	<p>33.30.29 Místní promáčklina v profilu</p> <ul style="list-style-type: none">■ Hrany nepoškozeny			
	<p>33.30.30 Klín vytržen Klín Chybějící</p>	 		

PERI Nájemní kritéria

PERI UP Schodiště



Horizontála se sponou (106626)	Popis	Pokyny	Fakturace	Typ
--------------------------------	-------	--------	-----------	-----



33.30.31 Profil ohnutý na hraně

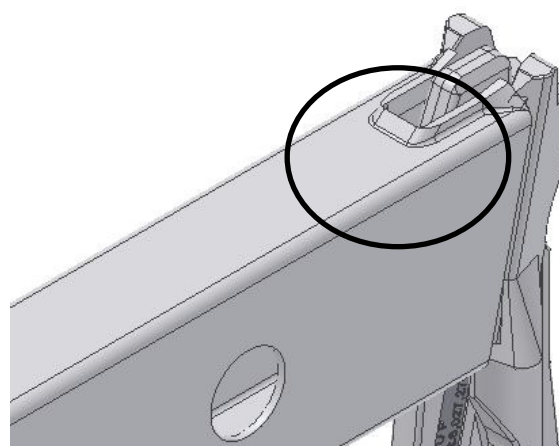

33.30.32 Deformace na klínu a okolo

■ Pokud možno



088244



■ Nebo pokud nadále nepoužitelné





■ Nebo pokud je prasklina v materiálu



PERI Nájemní kritéria

PERI UP Schodiště





















Horizontála se sponou (106626)	Popis	Pokyny	Fakturace	Typ
	33.30.33 Vymačkaná díra	<ul style="list-style-type: none"> ■ Pokud původní tvar díry nezměněn 	 088244	
	<ul style="list-style-type: none"> ■ Nebo pokud tvar změněn 	 		
	<ul style="list-style-type: none"> ■ Nebo pokud je trhlina v materiálu 	 		
	33.30.34 Profil ohnutý	 		

PERI Nájemní kritéria

PERI UP Schodiště





Horizontála se sponou (106626)	Popis	Pokyny	Fakturace	Typ
	33.30.35 Připojení ohnuté			
	<ul style="list-style-type: none"> ■ Pokud možno srovnat 			
	<ul style="list-style-type: none"> ■ Pokud již není použitelné 	 		
<ul style="list-style-type: none"> ■ Pokud je prasklina ve sváru 	 			
	33.30.36 Šrouby Matky			
	<ul style="list-style-type: none"> ■ Chybějící 	 024900 (Šroub) 781053 (Matka)		
<ul style="list-style-type: none"> ■ Nebo pokud poškozeno 	 024900 (Šroub) 781053 (Matka)			

PERI Nájemní kritéria

PERI UP Schodiště



Podestová výstuha (108034; 108000; 108172; 108179)	Popis	Pokyny	Fakturace	Typ	
	33.30.37 Připojení ohnuté	<ul style="list-style-type: none"> ■ Pokud lze, možno srovnat za studena 			
	<ul style="list-style-type: none"> ■ Pokud nelze srovnat za studena 				
	<ul style="list-style-type: none"> ■ Pokud je poškozený svár 				
	33.30.38 Vyztužení ohnuté	<ul style="list-style-type: none"> ■ Pokud funguje spojení a není poškozený svár 			
	<ul style="list-style-type: none"> ■ Pokud je svár poškozen 				
	<ul style="list-style-type: none"> ■ Pokud nefunguje spojení 				

PERI Nájemní kritéria

PERI UP Schodiště



Ocelové podlahy UDS Public	Č.	Popis	Katalogové číslo
----------------------------	----	-------	------------------

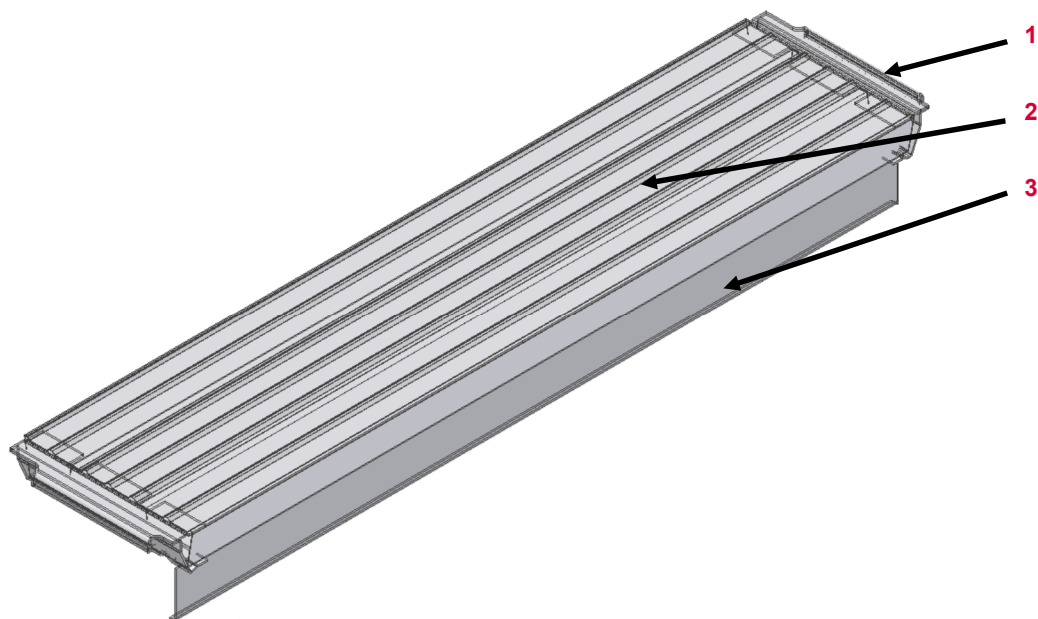















1	Připojení - kování	103339
2	Povrch UDS	
3	Postranní štít UDS	

Platí pro	
Ocelová podlaha UDS 32x150 Public	106585
Ocelová podlaha UDS 32x200 Public	106586
Ocelová podlaha UDS 32x250 Public	106587

PERI Nájemní kritéria

PERI UP Schodiště











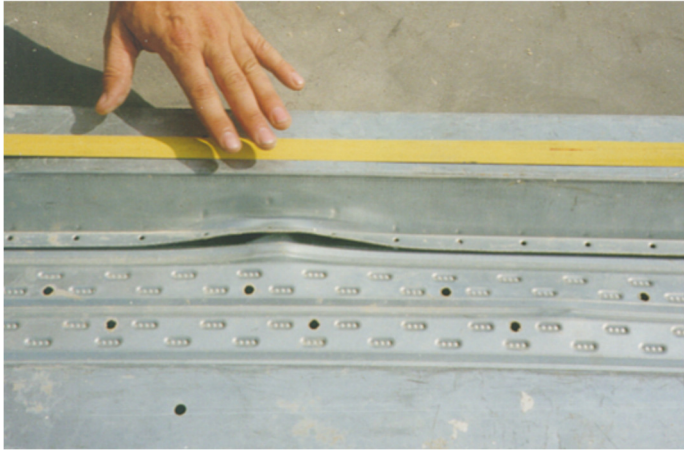





Ocelové podlahy UDS Public	Popis	Pokyny	Fakturace	Typ
	<p>33.30.39 Místní deformace v postranním profilu</p> <ul style="list-style-type: none"> ■ Pokud není poškozeno kování 	 		
	<p>33.30.40 Promáčkнутý postranní profil</p> <ul style="list-style-type: none"> ■ Osazení podlahy musí jít snadno 	 		
	<p>33.30.41 Promáčklina na konci podlahy</p>	 		

PERI Nájemní kritéria

PERI UP Schodiště

























Steel Deck UDS Public	Popis	Pokyny	Fakturace	Typ
	<p>33.30.42 Průhyb z vrchní strany</p> <ul style="list-style-type: none"> ■ > 10 mm ■ Tox spoje poškozeny 	   	 	 
	<p>33.30.43 Průhyb z vrchní strany l boku—přes hranu</p> <ul style="list-style-type: none"> ■ > 10 mm 	 		

PERI Nájemní kritéria

PERI UP Schodiště





















Ocelová podlaha UDS Public	Popis	Pokyny	Fakturace	Typ
	33.30.44 Díra v povrchu <ul style="list-style-type: none"> ■ ≤ 10 mm a žebro nepoškozeno 	 		
	<ul style="list-style-type: none"> ■ Nebo > 10 mm ■ Nebo žebro poškozeno 	 		
	33.30.45 Zavařené díry v povrchu <ul style="list-style-type: none"> ■ ≤ Ø 25 mm 	 		
	<ul style="list-style-type: none"> ■ Hrana poškozena ■ Žebro poškozeno 	 		
	33.30.46 Rezavý povrch <ul style="list-style-type: none"> ■ Pouze povrchová koroze! 			

PERI Nájemní kritéria

PERI UP Schodiště



Ocelové podlahy UDS Public	Popis	Pokyny	Fakturace	Typ
	33.30.47 Zlámané/Chybějící nýty			
	33.30.48 Třmen pojistky kování			
	<ul style="list-style-type: none"> ■ Ohnutý  ■ Nebo zlomený  		 	 
	33.30.49 Postranní plech ohnutý			
	<ul style="list-style-type: none"> ■ Pokud možno  ■ Nebo pokud není nadále použitelné  108476 (150) 108531 (200) 		 	 

PERI Nájemní kritéria

PERI UP Schodiště



Podlahy UZD Podestový překlad UZD	Č.	Popis	Katalogové číslo
-------------------------------------	----	-------	------------------

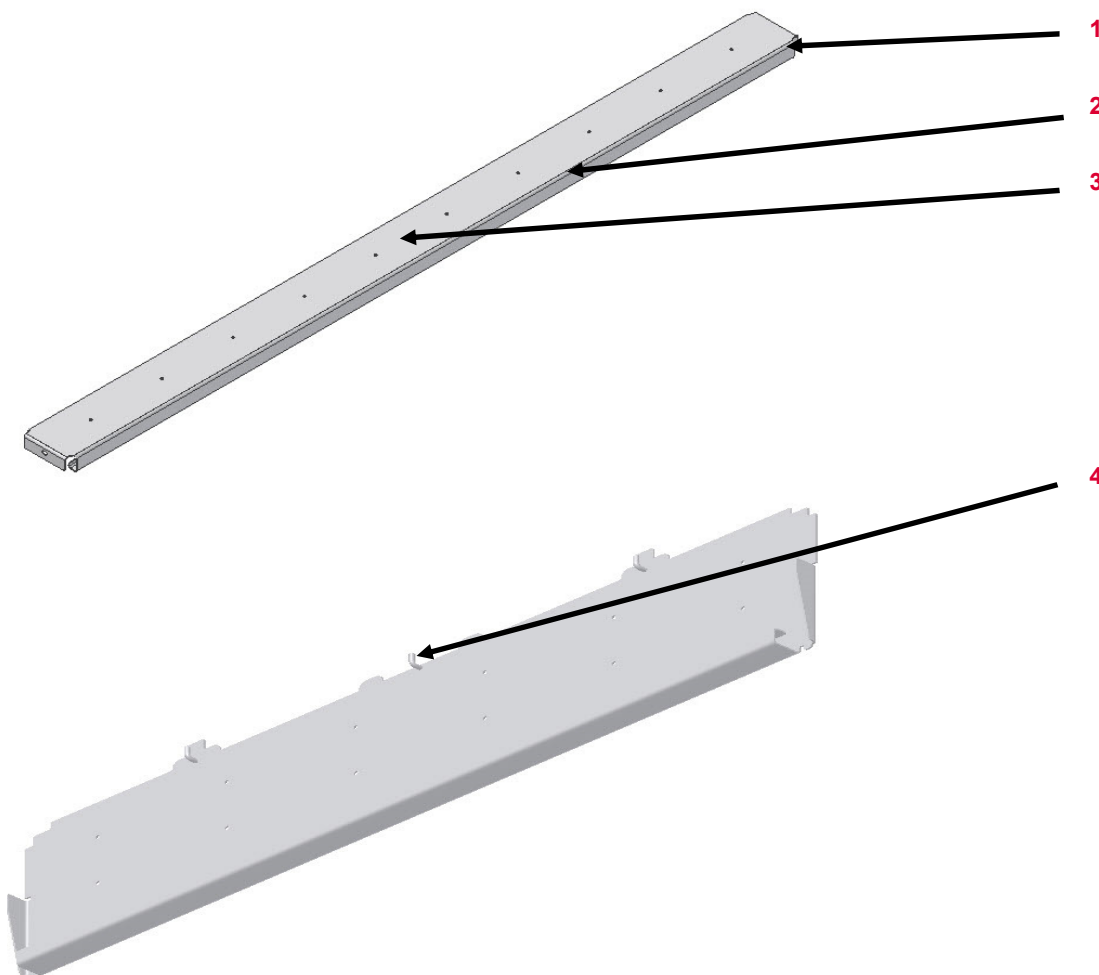

















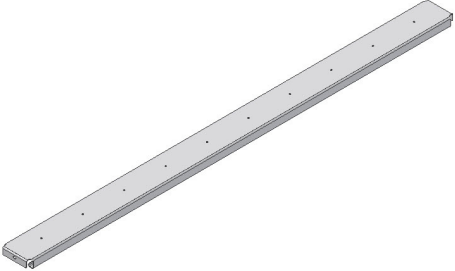



1	1	Závěs
2	2	Postranní profil
3	3	Povrch
4	4	Hák

Platí pro	
Podlaha UZD 150/16	107981
Podlaha UZD 150/31	107986
Podlaha UZD 150/37	107977
Podlaha UZD 200/16	108010
Podlaha UZD 250/16	108011
Podestový překlad UZD 150/25	108412

PERI Nájemní kritéria

PERI UP Schodiště



Podlahy UZD Podestový překlad UZD	Popis	Pokyny	Fakturace	Typ
	33.30.50 Hák ohnutý <ul style="list-style-type: none"> ■ Pokud možno narovnat za studena 			
	<ul style="list-style-type: none"> ■ Pokud nadále nepoužitelné 			
	33.30.51 Podlaha ohnutá <ul style="list-style-type: none"> ■ Spojení možné 			
	<ul style="list-style-type: none"> ■ Nebo pokud nadále nepoužitelné 			
	33.30.52 Postranní profil ohnutý <ul style="list-style-type: none"> ■ Pokud možno narovnat za studena 			
	<ul style="list-style-type: none"> ■ Nebo pokud nadále nepoužitelné 			

PERI Nájemní kritéria

PERI UP Schodiště



Podestový plech UAB (101671)	Popis	Pokyny	Fakturace	Typ
	33.30.53 Připojení ohnuté		 088244	
	33.30.54 Podestový plech ohnutý		 088244	

PERI Nájemní kritéria

Vysvětlivky Znak



Znak	Význam	Znak	Význam	Znak	Význam
	Šrot		Vyfakturovat zákazníkovi		Vizuální poškození
	OK– materiál zůstane v nájemním skladu		Nefakturovat zákazníkovi		Funkční poškození
	Šrotový materiál– není povoleno vydávat kvůli bezpečnosti		Zkrácení		Funkční poškození — není povolen výdej materiálu
	Oprava dle pokynů		Označení		Statické poškození—NENÍ povolen výdej z bezpečnostních důvodů
	Oprava za studena– Později zkontrolovat svár , švy a okraje		Výměna poškozené části		
	Opravit pouze když se to vyplatí		Doplnění náhradního dílu		
	Čištění materiálu				