

# PERI Nájemní kritéria

## PERI UP Prvky pro podskružení

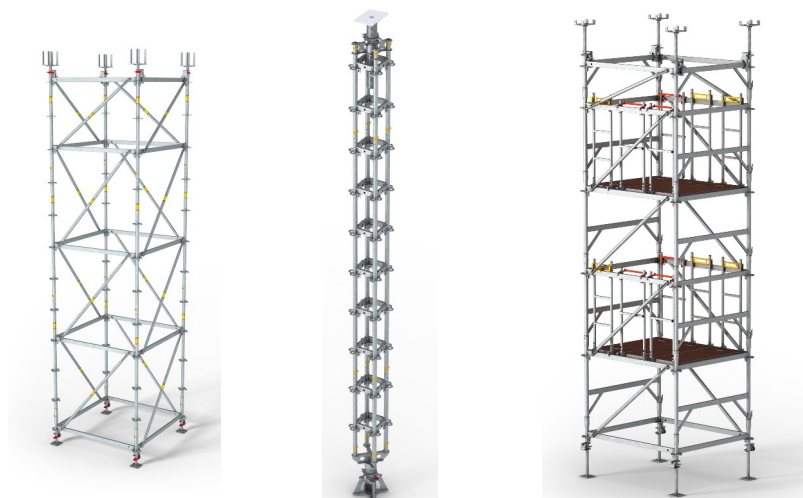

Obsah	Strana	Poslední změny	Datum   Iniciály	Strana
Poklesová patka HD	2	Nová verze	07/2017 I fw	
Hlava TR 110-80/55	5			
Hydraulické zařízení HD	8			
Diagonála UBS	12			
Vysvětlivky	15			

### Kontakt

**PERI, spol. s r.o.**  
**bednění lešení služby**

Průmyslová 392  
252 42 Jesenice u Prahy  
tel.: 222 359 311  
info@peri.cz  
www.peri.cz

# PERI Nájemní kritéria

## PERI UP Prvky pro podskružení



### Poklesová patka HD (126436)

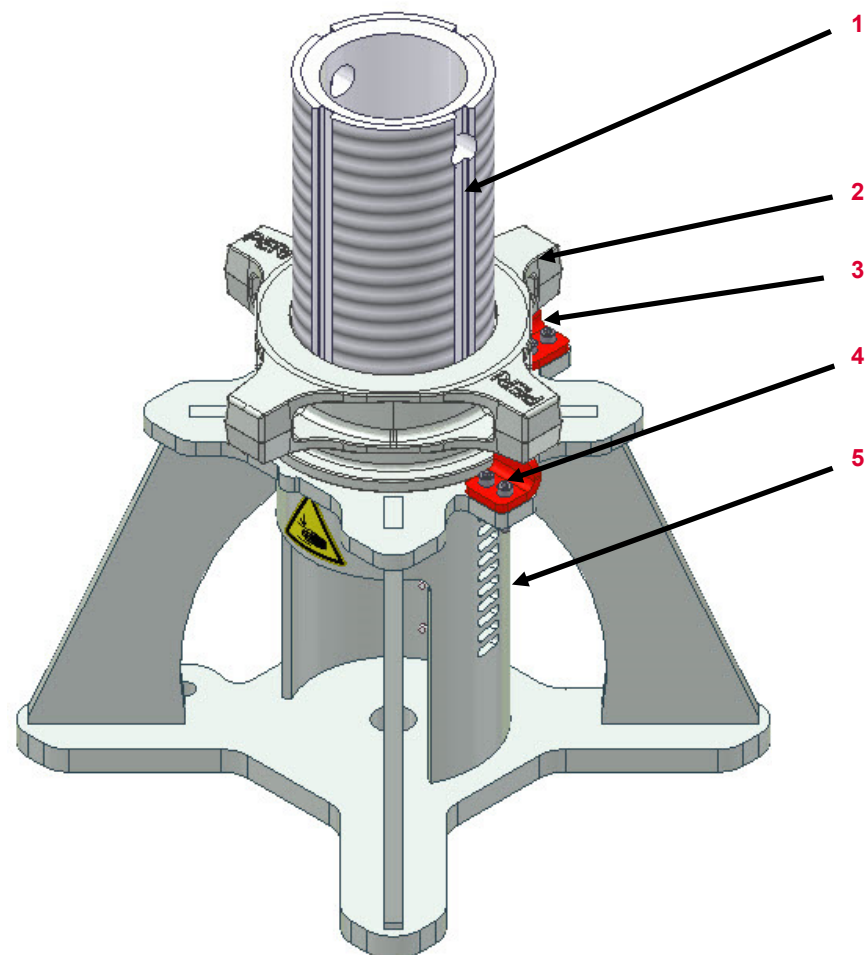











Č.	Popis	Číslo výrobku
1	Vřeteno	127117
2	Nastavovací matice TR 110x9	780149
3	Zarážka	127114
4	Nýt M5x25	127077
5	Patka	127123

# PERI Nájemní kritéria

## PERI UP Prvky pro podskružení











Poklesová patka HD (126436)	Popis	Instrukce	Fakturace	Typ
	<b>33.60.01 Poškozená nastavovací matice</b>			
	<b>33.60.02 Zarážka</b>			
	■ Vylomená			
	■ Chybějící			

# PERI Nájemní kritéria

## PERI UP Prvky pro podskružení



Poklesová patka HD (126436)	Popis	Instrukce	Fakturace	Typ
	33.60.03 Nečitelný typový štítek			
	33.60.04 Závit poškozený			

# PERI Nájemní kritéria

## PERI UP Prvky pro podskružení



### Hlava TR 110-80/55 (126435)

Č. Popis Číslo výrobku

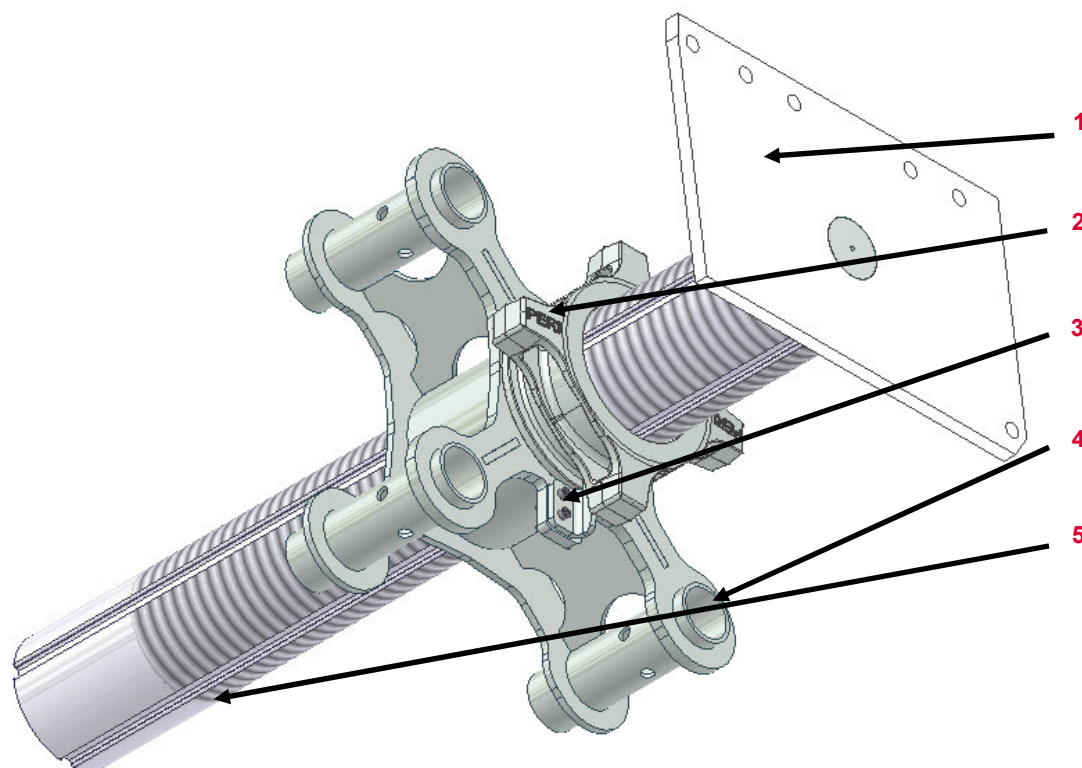







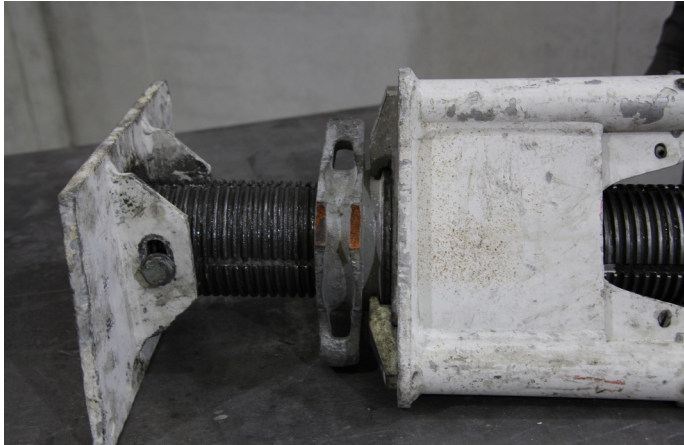

1	Oscilační deska	785263
2	Nastavovací matice TR 110x9	780149
3	Zarážka	127101
4	Připojení trubky	127110
5	Vřeteno	127102

# PERI Nájemní kritéria

## PERI UP Prvky pro podskružení



Hlava TR 110-80/55 (126435)	Popis	Instrukce	Fakturace	Typ
	33.60.05 Poškozená nastavovací matice			
	33.60.06 Ohnutá oscilační deska			

# PERI Nájemní kritéria

## PERI UP Prvky pro podskružení



Hlava TR 110-80/55 (126435)	Popis	Instrukce	Fakturace	Typ
	<b>33.60.07 Ohnuté připojení trubky</b>			
	■ Osazení je možné			
	■ Není možné osadit			
	■ Prasklina v materiálu			
	<b>33.60.08 Zarážka</b>			
	■ Vylomená			
	■ Chybějící			

# PERI Nájemní kritéria

## PERI UP Prvky pro podskružení



Hydraulické zařízení HD (126438)	Č.	Popis	Číslo výrobku
----------------------------------	----	-------	---------------

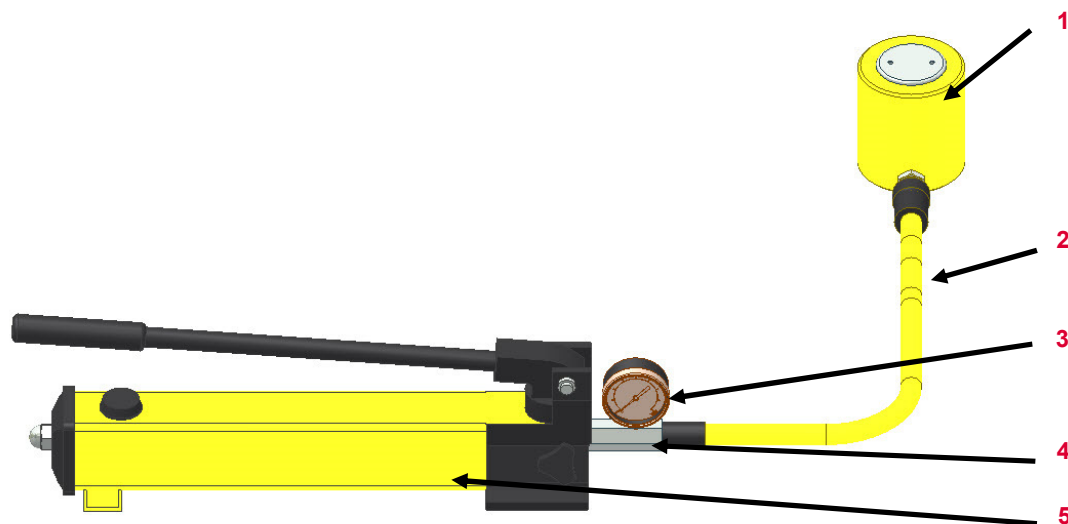



1	Válec	130792
2	Hydr. hadice	130791
3	Tlakoměr	130789
4	Připojení tlakoměru	130788
5	Pumpa	130787



# PERI Nájemní kritéria

## PERI UP Prvky pro podskružení











Hydraulické zařízení HD (126438)	Popis	Instrukce	Fakturace	Typ
	<b>33.60.09 Válec není funkční</b>			
	■ Z důvodu opotřebení			
	<b>33.60.10 Hadice</b>			
	■ Propustná			
	■ Zaříznutá			

# PERI Nájemní kritéria

## PERI UP Prvky pro podskružení



Hydraulické zařízení HD (126438)	Popis	Instrukce	Fakturace	Typ
	33.60.11 Tlakoměr nefunkční			
	33.60.12 Pumpa nefunkční			

# PERI Nájemní kritéria

## PERI UP Prvky pro podskružení



Adaptér UJC (126437)	Popis	Instrukce	Fakturace	Typ	
	<b>33.60.13 Čep ohnutý   promáčknutý</b>				
	<b>33.60.14 Nýt   Závlačka</b>	<ul style="list-style-type: none"><li>■ Chybějící</li><li>■ Ohnutá</li></ul>	<ul style="list-style-type: none"><li> 127086 (Nýt)</li><li>018060 (Závlačka)</li><li>711074 (Podložka)</li></ul> <ul style="list-style-type: none"><li> 127086 (Nýt)</li><li>018060 (Závlačka)</li><li>711074 (Podložka)</li></ul>		

# PERI Nájemní kritéria

## PERI UP Prvky pro podskružení



### Diagonála UBS

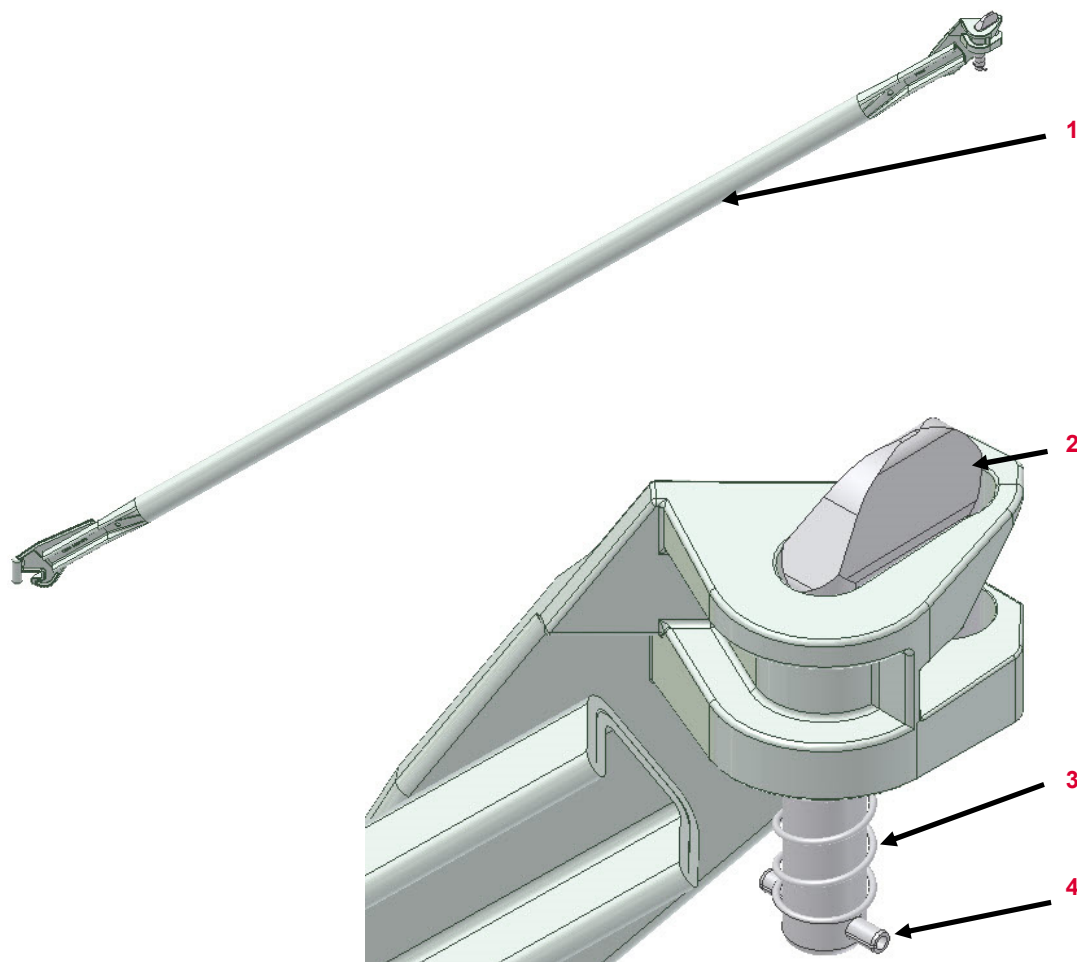

Č.	Popis	Číslo výrobku
1	Diagonála	
2	Nýt UBK	100520
3	Pružinka	722573
4	Kolík	710683











#### Platné pro:

Diagonála UBS 100/100	128936
Diagonála UBS 150/100	107801
Diagonála UBS 200/100	115504
Diagonála UBS 250/100	123592
Diagonála UBS 300/100	123584
Diagonála UBS 100/150	129354
Diagonála UBS 150/150	107810
Diagonála UBS 200/150	115291
Diagonála UBS 250/150	123588
Diagonála UBS 300/150	123580

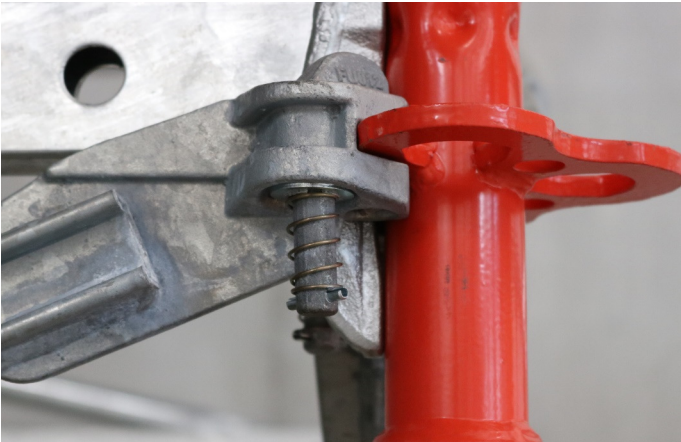
# PERI Nájemní kritéria

## PERI UP Prvky pro podskružení























Diagonála UBS	Popis	Instrukce	Fakturace	Typ
	<b>33.60.25 Pružinka nefunkční   nepohyblivá</b>			
	<b>33.60.26 Nýt</b>			
	<ul style="list-style-type: none"><li>■ Chybějící</li><li>■ Vylomený</li></ul>	 	 	 

# PERI Nájemní kritéria

## PERI UP Prvky pro podskružení



Diagonála UBS	Popis	Instrukce	Fakturace	Typ
	<b>33.60.27 Nýt vylomená   Chybějící spoj</b>	 		
	<b>33.60.28 Ohnutý čep</b>			
	<ul style="list-style-type: none"> <li>■ Čep může být osazen</li> </ul>			
	<ul style="list-style-type: none"> <li>■ Není možné osadit</li> </ul>	 		
	<ul style="list-style-type: none"> <li>■ Prasklina v materiálu</li> </ul>	 		

# PERI Nájemní kritéria

## Vysvětlivky znaků



Znak	Význam	Znak	Význam	Znak	Význam
	Není v pořádku – materiál je poškozený		Fakturuje se zákazníkovi		Optické poškození
	OK – materiál zůstává v nájemním skladu		Nefakturuje se zákazníkovi		Funkční poškození
	Poškozený materiál – <b>není dovoleno</b> vydávat materiál z bezpečnostních důvodů		Zkrácení prvku		Funkční poškození — <b>není dovoleno</b> vydávat materiál z bezpečnostních důvodů
	Oprava dle instrukcí		Označení prvku barvou		Statické poškození — <b>není dovoleno</b> vydávat materiál z bezpečnostních důvodů
	Oprava za studena — poté kontrola svárů a sousedních dílů		Výměna poškozeného dílu		
	Oprava po výpočtu hospodárnosti		Doplnění chybějícího dílu		
	Očištění materiálu				